

### 3. Installation 2/2

#### Windows 8 Start here

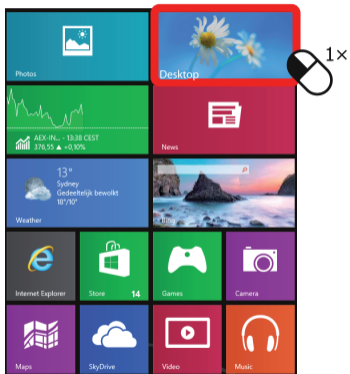

#### Windows 10/8/7/Vista Start here

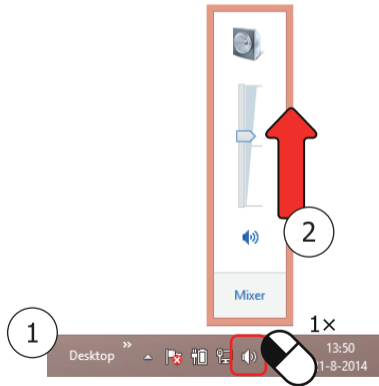

**Trust**

**COMPACT**  
2.0 speaker set

POLO



**Quick Installation Guide**

## 1. Speaker set

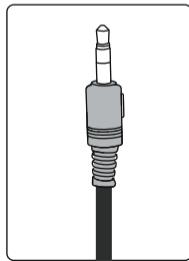
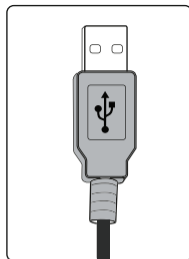
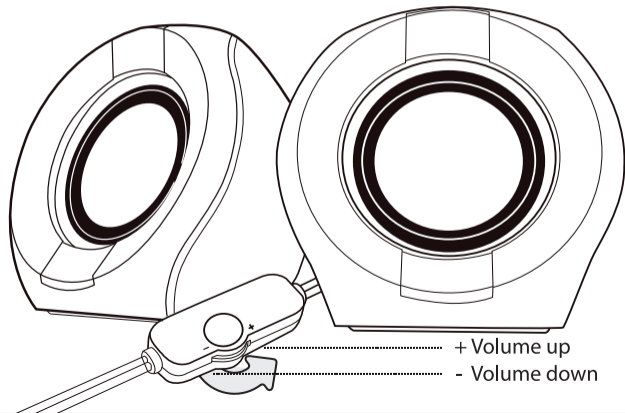

## 2. Installation 1/2

### Option 1

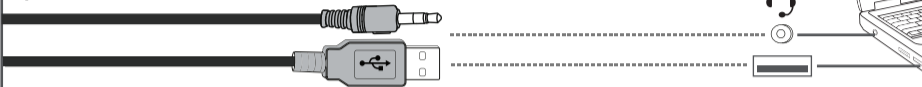

### Option 2

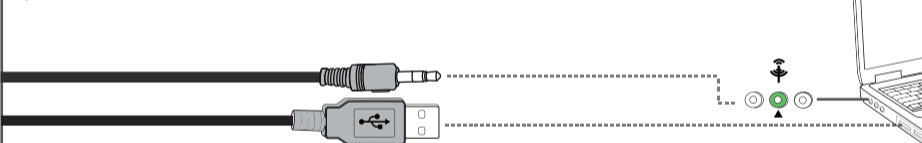

### Option 3

