

INSTALLATION INSTRUCTION

Enclosed Safety Switches

OTE16...90_

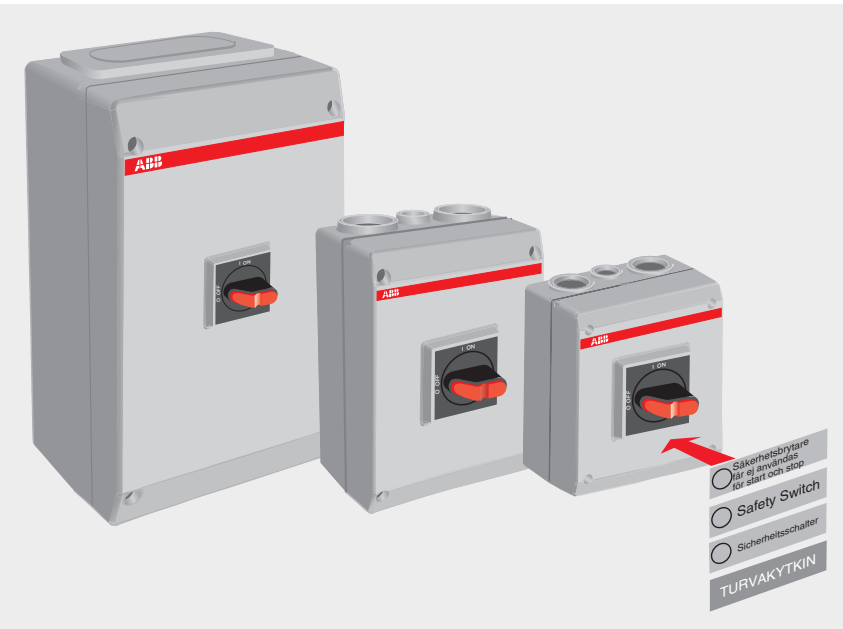

Terminal markings

OTE_3_

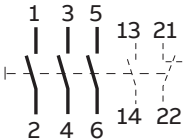

OTE_4_

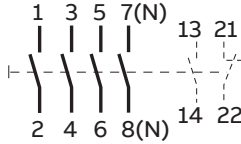

OTE_6_

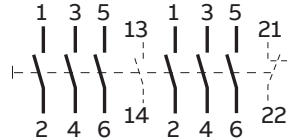

Opening of cover

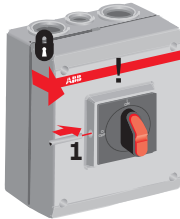

A00064A1

Cable input

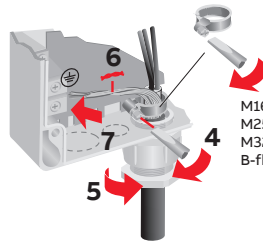
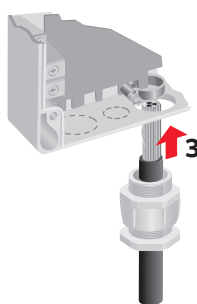
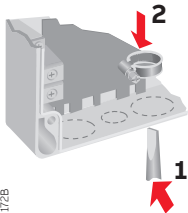

M16 = 2,5 Nm
 M25 = 2,5 Nm
 M32 = 2,5 Nm
 B-flange/M50 = 3 Nm

A00172B

Wiring for OTE16_

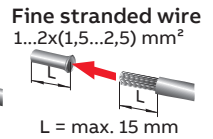
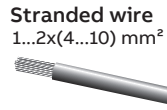
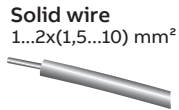
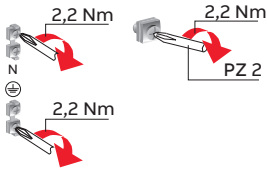

OTE16_3_, OTE_16_4_

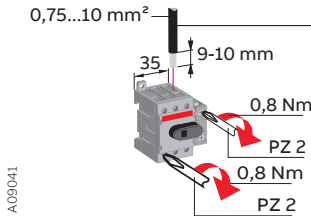

A09041

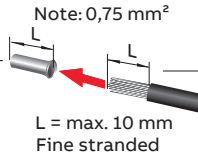

OTE16_6_

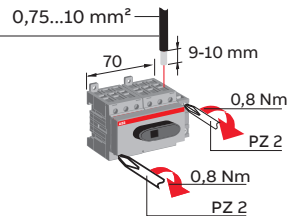

Dimension drawings

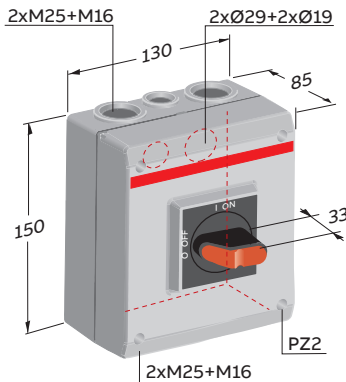

A09042A

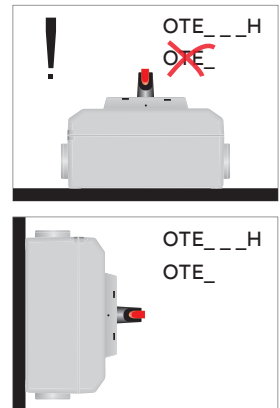
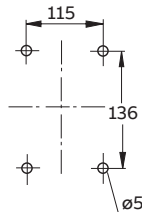

Wiring for OTE25_ to OTE63_

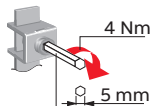
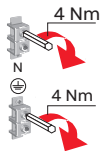

Solid wire
(1,5...35) mm²



Stranded wire
(6...35) mm²



Fine stranded wire
(1,5...4) mm²

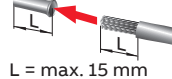

OTE25_3_, OTE25_4_
OTE36_3_, OTE36_4_

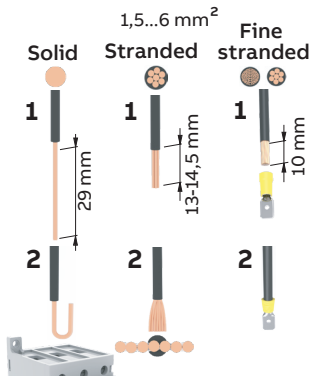
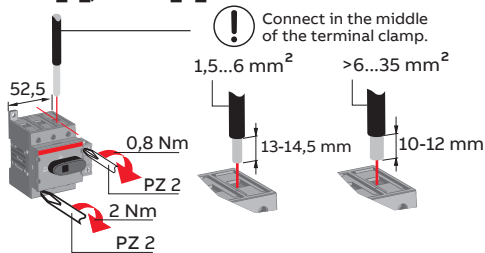

OTE 63_3_

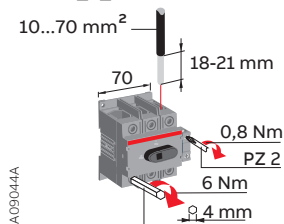

A09044A

Dimension drawings

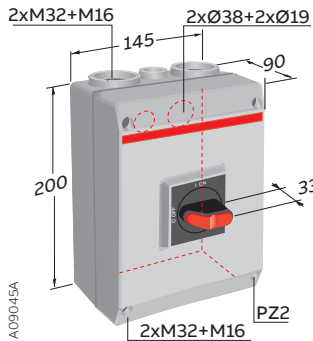

A09045A

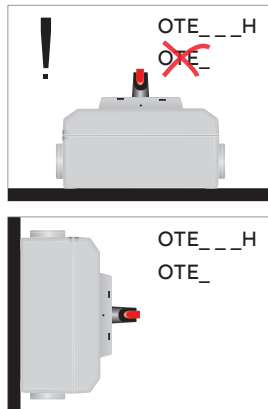
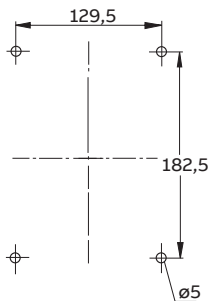

Wiring for OTE25_ to OTE90_

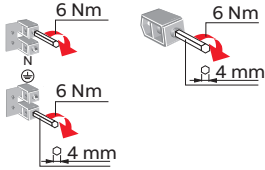

Solid and stranded wire (10...70)mm²

Fine stranded wire (10...70)mm²

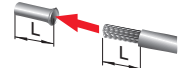

L = max. 25 mm

OTE_25_6_, OTE_36_6_

! Connect in the middle of the terminal clamp.

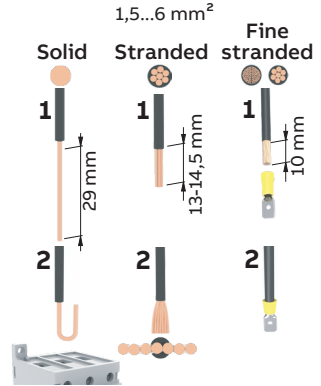
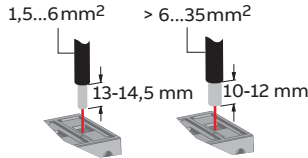
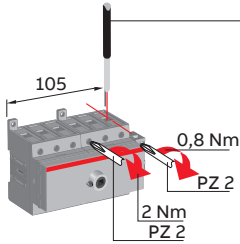

OTE_75_3_, OTE_75_4_, OTE_90_3_, OTE_90_4_

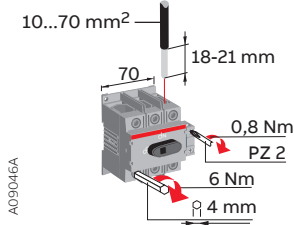

A09046A

OTE_63_6_ OTE_75_6_, OTE_90_6_

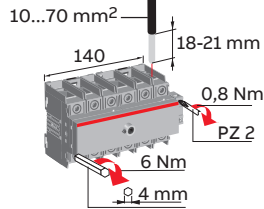

Dimension drawings

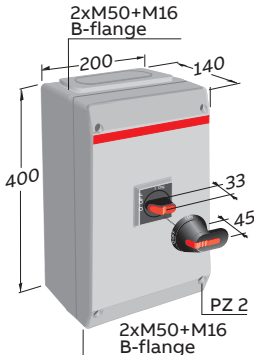

A09048A

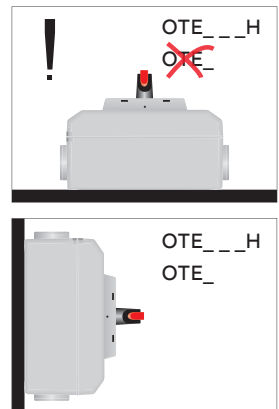
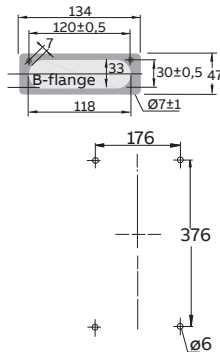

Padlocking handle

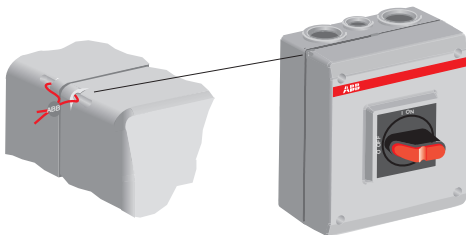
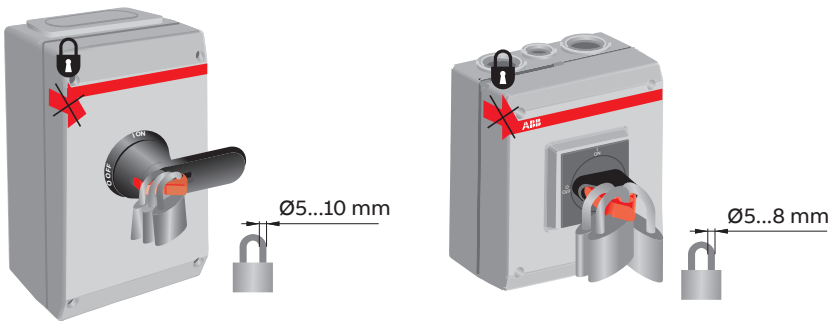
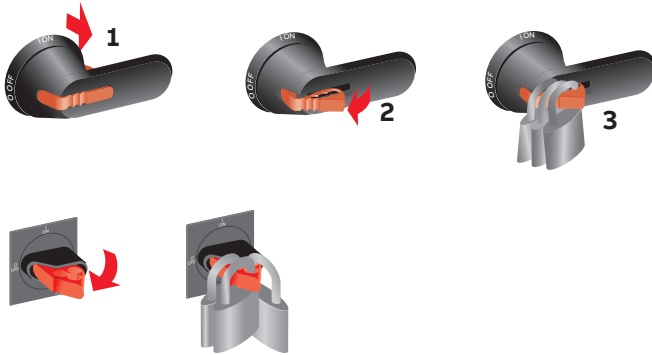



BG	Внимание! Опасно напряжение! Да се монтира само от лице с електротехническа квалификация.
FR	Avertissement! Tension électrique dangereuse! Installation uniquement par des personnes qualifiées en électrotechnique.
MT	Twissija! Vultaġġ perikoluż! Għandu jiġi installat biss minn persuna b'kompetenza elettroteknika.
HR	Upozorenje! Opasan napon! Postavljati smije samo elektrotehnički stručnjak.
DE	Warnung! Gefährliche Spannung! Installation nur durch elektrotechnische Fachkraft.
PL	Ostrzeżenie! Niebezpieczne napięcie! Instalacji może dokonać wyłącznie osoba z fachową wiedzą w dziedzinie elektrotechniki.
CZ	Varování! Nebezpečné napětí! Montáž smí provádět výhradně elektrotechnik!
EL	Προειδοποίηση! Υψηλή τάση! Η εγκατάσταση πρέπει να γίνεται μόνο από εξειδικευμένους ηλεκτροτεχνικούς.
PT	Aviso! Tensão perigosa! A instalação só deve ser realizada por um electricista especializado.
DA	Advarsel! Farlig elektrisk spænding! Installation må kun foretages af personer med elektroteknisk ekspertise.
HU	Figyelmeztetés! Veszélyes feszültség! Csak elektrotechnikai tapasztalattal rendelkező szakember helyezheti üzembe.
RO	Avvertizare! Nevarena pericoloaşă! Instalarea trebuie efectuată numai de către o persoană cu experiență în electrotehnică.
NL	Waarschuwing! Gevaarlijke spanning! Mag alleen geïnstalleerd worden door een deskundige elektrotechnicus.
IE	Rabhadh! Voltas guaiseach! Ba chóir do dhuine ag a bhfuil saineolas leictreicéiníúil, agus an té sin amháin, é seo a shuiteáil.
SK	Varovanie! Nebezpečné napätie! Montáž môže vykonávať iba skúsený elektrotechnik.
EN	Warning! Hazardous voltage! Installation by person with electrotechnical expertise only.
IT	Avvertenza! Tensione pericolosa! Fare installare solo da un elettricista qualificato.
SL	Opozorilo! Nevarna napetost! Vgradnjo lahko opravi le oseba z elektrotehničnim strokovnim znanjem.
ET	Hoiatus! Ohtlik pinge. Paigaldada võib ainult elektrotehnika-alane ekspert.
LV	Uzmanību! Bīstami - elektrība! Montāžas darbus drīkst veikt tikai personas, kurām ir atbilstošas elektrotehniskās zināšanas.
ES	¡Advertencia! ¡Tensión peligrosa! La instalación deberá ser realizada únicamente por electricistas especializados.
FI	Varoitus! Vaarallinen jännite! Asennuksen voi tehdä vain sähköalan ammattihenkilö.
LT	Dėmesio! Pavojinga įtampa! Dirbti leidžiama tik elektrotechniko patirties turintiems asmenims.
SE	Varning! Farlig spänning! Installation får endast utföras av en elektriker.
CN	警告！电压危险！只能由专业电工进行安装。
RU	Осторожно! Опасное напряжение! Монтаж должен выполняться только специалистом-электриком.



Contact us

ABB Oy

P.O. Box 622
FI-65101 Vaasa
Finland

abb.com/lowvoltage