

PRODUCT FAMILY DATASHEET

Vintage 1906 Luminaire shades

Accessory for the PenduLum luminaires



AREAS OF APPLICATION

- Living areas (living rooms, dining rooms, bedrooms etc.)
- Professional (hotels, bars, boutiques etc.)

PRODUCT BENEFITS

- Semi-matt surface with great look and feel
- Easy mounting with included pins

PRODUCT FEATURES

- Modifies the appearance of the Vintage 1906 PenduLum



TECHNICAL DATA

Product description	Dimensions & weight			Colors & materials	
	Diameter	Height	Product weight	Body material	Product color
Vintage 1906 PenduLum Cage, black	239.0 mm	172.0 mm	400.00 g	Aluminum	Black
Vintage 1906 PenduLum Cage, gold	239.0 mm	172.0 mm	400.00 g	Aluminum	Gold
Vintage 1906 PenduLum Cone, black and gold	219.0 mm	134.0 mm	260.00 g	Aluminum	Black/Gold
Vintage 1906 PenduLum Cone, black and white	219.0 mm	134.0 mm	260.00 g	Aluminum	Black/White
Vintage 1906 PenduLum Cup, black and gold	140.0 mm	132.0 mm	140.00 g	Aluminum	Black/Gold
Vintage 1906 PenduLum Cup, black and white	140.0 mm	132.0 mm	140.00 g	Aluminum	Black/White
Vintage 1906 PenduLum Radar, black and gold	320.0 mm	124.0 mm	435.00 g	Aluminum	Black/Gold
Vintage 1906 PenduLum Radar, black and white	320.0 mm	124.0 mm	435.00 g	Aluminum	Black/White

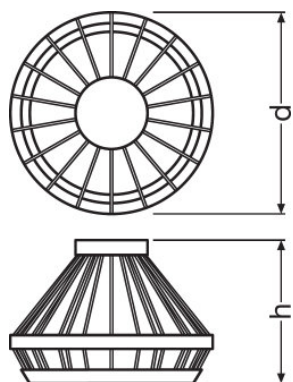

Vintage 1906 PenduLum Cage, black

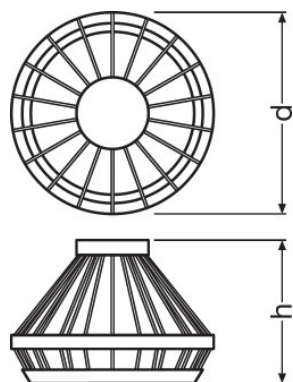

Vintage 1906 PenduLum Cage, gold

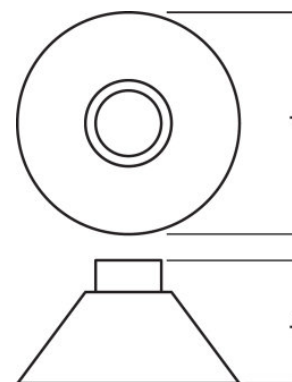

Vintage 1906 PenduLum Cone, black and gold

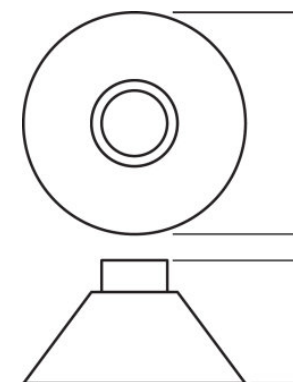

Vintage 1906 PenduLum Cone, black and white

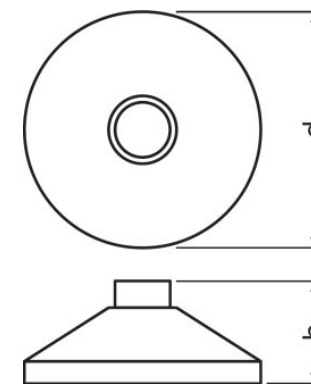
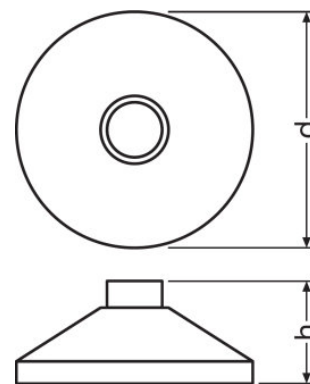
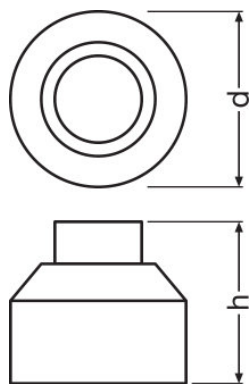
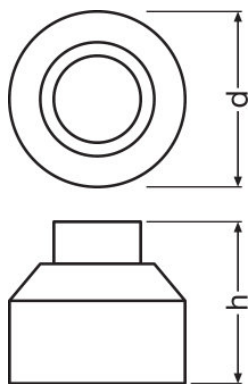

Vintage 1906 PenduLum Cup, black and gold

Vintage 1906 PenduLum Cup, black and white

Vintage 1906 PenduLum Radar, black and gold

Vintage 1906 PenduLum Radar, black and white

APPLICATION ADVICE

For more detailed application information and graphics please see product datasheet.

LOGISTICAL DATA

Product code	Product description	Packaging unit (Pieces/Unit)	Dimensions (length x width x height)	Volume	Gross weight
4058075073548	Vintage 1906 PenduLum Cage, black	Shipping carton box 4	502 mm x 502 mm x 234 mm	58.97 dm ³	2903.00 g
4058075073562	Vintage 1906 PenduLum Cage, gold	Shipping carton box 4	502 mm x 502 mm x 234 mm	58.97 dm ³	2903.00 g
4058075073524	Vintage 1906 PenduLum Cone, black and gold	Shipping carton box 4	502 mm x 502 mm x 234 mm	58.97 dm ³	2531.00 g
4058075073500	Vintage 1906 PenduLum Cone, black and white	Shipping carton box 4	502 mm x 502 mm x 234 mm	58.97 dm ³	2531.00 g
4058075073449	Vintage 1906 PenduLum Cup, black and gold	Shipping carton box 4	291 mm x 291 mm x 228 mm	19.31 dm ³	1674.00 g

Product code	Product description	Packaging unit (Pieces/Unit)	Dimensions (length x width x height)	Volume	Gross weight
4058075073425	Vintage 1906 PenduLum Cup, black and white	Shipping carton box 4	291 mm x 291 mm x 228 mm	19.31 dm ³	1291.00 g
4058075073487	Vintage 1906 PenduLum Radar, black and gold	Shipping carton box 4	533 mm x 366 mm x 407 mm	79.40 dm ³	2952.00 g
4058075073463	Vintage 1906 PenduLum Radar, black and white	Shipping carton box 4	533 mm x 366 mm x 407 mm	79.40 dm ³	2952.00 g

The mentioned product code describes the smallest quantity unit which can be ordered. One shipping unit can contain one or more single products. When placing an order, for the quantity please enter single or multiples of a shipping unit.

DISCLAIMER

Subject to change without notice. Errors and omission excepted. Always make sure to use the most recent release.