

## BAREBONE XPC slim XH510G2

### FLEXIBLE 4.75-LITRE PC WITH PCIe SLOT

The Shuttle XPC slim Barebone XH510G2 is a 4.75-litre PC with two slots for PCI-Express expansion cards. Together with an LGA 1200 Intel Core desktop processor of the Intel Core Gen 10/11 range, this platform is perfectly suited for many professional applications where performance, flexibility and a compact form factor matter. This includes video wall presentations, graphics workstations, media capturing, surveillance, POS, POI as well as network and industrial applications. Even mid-range gaming is possible.

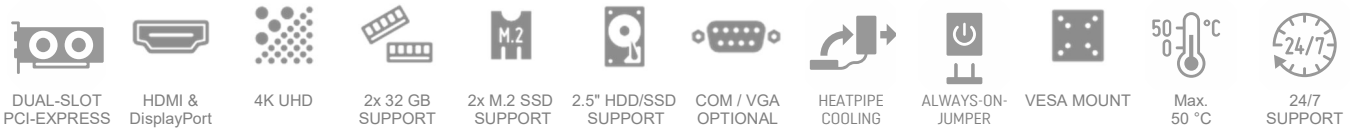

### SLIM DESIGN

- Robust 4.75-litre steel chassis, black
- Dimensions: 250 x 200 x 95 mm (LWH)
- Including VESA mount (75/100 mm)
- Supports 24/7 Non-stop Operation
- Operating temperature: 0~50 °C (non-condensing)

### OPERATING SYSTEM

- An operating system is not included
- Supports Windows 10, Windows 11 and Linux (64-bit)

### PROCESSOR SUPPORT

- Socket LGA1200 supports 10<sup>th</sup>- and 11<sup>th</sup> Gen Intel Core i9/i7/i5/i3, Pentium Gold und Celeron processors, codenamed "Comet Lake-S" and "Rocket Lake-S", max. 65W TDP
- Includes heatpipe cooling system with two fans

### TWO PCIe SLOTS

- 1x PCI Express X16 v4.0/v3.0 slot
- Supports dual-slot expansion cards with max. 208 x 120 x 45 mm in size and max. 75 W TDP
- 1x PCI Express X1 v3.0 slot (not usable with dual-slot graphics card)
- 5V auxiliary voltage (max. 2 A) with 4-pin Molex connector

### CHIPSET

- Intel H510 Chipset

### MEMORY SUPPORT

- 2x 260-pin SO-DIMM slot
- Supports DDR4-3200/2933/2666
- max. 2x 32 GB

### STORAGE - SATA / M.2

- 1x 2.5" bay for SATA hard disk or SSD, max. 9.5 mm
- 2x M.2-2280M slot for SSD cards (both support SATA, one supports PCIe x4 NVMe)
- 1x M.2-2230E for an optional WLAN card

### CONNECTORS

- HDMI 2.0a/1.4b
- DisplayPort 1.4
- 4x USB 3.2 Gen1
- 4x USB 2.0
- 1x USB 2.0 internal port für USB stick
- 2x audio (line out, mic)
- Intel Gigabit LAN (RJ45)
- Connector for external power button
- "Always-On" jumper
- DC input

### POWER SUPPLY

- External 180 W / 19.5 V power adapter

### OPTIONAL ACCESSORIES

- WLAN Module (WLN-M, WLN-M1)
- RS232 COM port (PCP11)
- D-Sub VGA port (PVG01)
- LTE Adapter Kit (WWN03)
- Cable for external power button (CXP01)



**Note:** Some features market in red color are only supported in combination with Gen 11 "Rocket Lake-S" processors.

## PRODUCT FEATURES



### The slim chassis - a clean and modern look

Shuttle has always placed great emphasis on the interior and exterior aesthetics of their Mini-PCs with the belief that a good blend of style and form factor allows the Mini-PC to be attractive, versatile and work well in almost any environment. The XH510G2 was designed just like that and shines in a clean and modern appearance. The front panel connectors are easy to access for daily use, and this tiny tot barely stands at 7.85 cm in height.



### VESA mount included

With the supplied VESA mount you can easily attach the XH510G2 to the backside of an appropriate display, to a VESA arm or just to the wall. It is compatible with 75x75 mm and 100x100 mm VESA standards.



### Supports 10/11<sup>th</sup> Generation Intel® Core™ processors

"Comet Lake-S" and "Rocket Lake-S" are the codenames for Intel's 10<sup>th</sup> and 11<sup>th</sup> Generation of Intel® Core™ Desktop Processors for socket LGA1200 in combination with the 500-Series chipsets. Corresponding processors feature up to 10 cores and 20 threads and 20 MB of cache memory. With an optimal balance of frequency, cores and threads, these processors help supercharge Shuttle XPCs for maximum productivity in professional and mainstream applications.



### Low noise thanks to heatpipe cooling system

An active dual-fan heatpipe cooling system ensures whisper-quiet operation and system stability. A heatpipe is a hollow tube containing a liquid to transfer heat. As the liquid evaporates, it carries heat to the cool end, where it condenses and then runs back to the hot end. Heatpipes have a much higher thermal conductivity than solid materials. Please keep the vent holes clear.



### 4K Display support

The XH510G2 features one HDMI and one DisplayPort video output for 4K (3840 x 2160 / 2160p) high resolution at 60 Hz frames per second.

Note: HDMI supports UHD at max. 30Hz with Comet Lake Prozessors.



### Supports extended temperature range and 24/7 operation

The Shuttle XPC slim Barebone XH510G2 is officially approved for 24/7 permanent operation. Thanks to its efficient cooling, this PC runs highly reliable making it perfectly suitable for digital signage and POI/POS applications - even at ambient temperatures of up to 50 °C (non-condensing).

**Caution:** For high ambient temperatures over 40 °C we strongly recommend to use SSDs.

### M.2



### Two M.2-Slots for SSD cards

XH510G2 even offers two M.2-2280M slots for M.2 SSD flash memory cards - both support SATA and one also supports NVMe/PCIe. Type 2280 means, it supports the usual M.2 cards with a width of 22 mm and a length of 80 mm, but also 2242 and 2260 standard cards are supported.

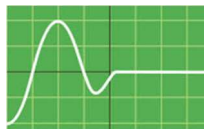

### Power on after Power fail

The BIOS setup provides a "Power-On after Power Fail" function that can be found under "Power Management Configuration". As the name indicates, this function determines the PC's behaviour after power failure: (1) unconditional power on, (2) restore former status (3), keep system turned off (4), Power-On by LAN or (5) Power-On by Real-Time-Clock. As a matter of the nature of this function, it may fail after short power failures. This is why the XH510G2 also comes with a hardware-based solution. By removing Jumper JP1, the system will start unconditionally once power is applied.



### External power button by separate remote line

If, because of space constraints (e.g. in case of fixed installation), the machine cannot be switched on by pressing the front power button, it can be powered on by a separate remote line. You will find an appropriate four-pin connector at the back panel of the XH510G2 (pitch 2.54 mm). Furthermore, this connector provides a Clear CMOS function and +5V DC voltage supply for external devices.

+5V voltage (2) (4) Power Button  
Clear CMOS (1) (3) Ground

## REQUIRED COMPONENTS

The following components need to be added to make it a fully-configured Mini PC

### Shuttle XPC slim Barebone XH510G2

Top view:



Bottom view:



### LGA1200 Processor

Intel Core Gen 10 "Comet Lake-S" or Gen 11 "Rocket Lake-S" Core i9 / i7 / i5 / i3, Pentium Gold or Celeron  
TDP max. 65 W



### Memory Modules

Up to two DDR4-2666/2933 SO-DIMM memory modules  
max. 32 GB each

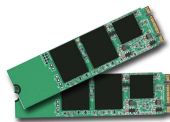

### Up to two M.2 SSDs

Supports one M.2-2280/2260/2242 SSD card with SATA or PCIe/NVMe interface  
Supports a second M.2-2280 SSD card with SATA



### PCI-Express Card

e.g. Dual Slot Graphics Card, PCIe X16, max. 75 W TDP  
Dimensions: max. 208 mm x 120 mm x 45 mm



### 2.5" Storage Drive

SATA hard disk or Solid State Disk (SSD)  
(max. height: 9.5 mm)



### Operating System

Windows 10/11 or Linux (64-bit only)

## OPTIONAL ACCESSORIES FROM SHUTTLE



### COM-Port-Adapter **PCP11**

To add a COM-Port (RS232) in the back panel. This accessory cannot be used in combination with PVG01.



### VGA port adapter **PVG01**

To add an analog D-Sub/VGA-Port in the back panel. This accessory cannot be used in combination with PCP11.



### LTE Adapter Kit **WWN03**

allows the installation of an M.2 LTE card and nano SIM card. This adapter is screwed to the chassis from the inside.



### Cable **CXP01**

Cable for external push button switch (without button)



### WLAN-Accessory

#### **WLN-M / WLN-M1**

M.2-2230 card supports WLAN and Bluetooth including 2 antennas

## EXAMPLES WITH EXPANSION CARDS



Despite its compact dimensions, the Shuttle XPC slim Barebone XH510G2 sports a full-size PCI-Express-X16 slot for dual-slot cards not exceeding 208 mm (length), 120 mm (height) and 45 mm (width) and max. 75 W power consumption. At the same time, other powerful PC components such as an Intel Core i9 processor or 64 GB RAM are supported. This makes it particularly versatile in use which often asked for a bigger PC in the past.

Photo: Shuttle XPC slim Barebone XH510G2 with powerful graphics card installed.

Including 4-pin Molex connector with 5V/2A auxiliary voltage for special expansion card:



EXPANSION CARD	POSSIBLE APPLICATIONS
<b>Gaming Graphics Card</b> e.g. (Dual Slot) Palit GeForce GTX 1050 Ti StormX Gainward GeForce GTX 1050 Ti	<ul style="list-style-type: none"> <li>• Gaming PC</li> <li>• 3D Workstation</li> </ul>
<b>Multi-port Graphics Card</b> e.g. AMD FirePro W600 or Matrox C680 with 6x Mini-DisplayPort	<ul style="list-style-type: none"> <li>• Visualisation for Control Rooms</li> <li>• Surveillance and Security</li> <li>• Digital Signage with Video Wall</li> <li>• Information Display (POI)</li> </ul>
<b>CAD Graphics Card</b> e.g. NVIDIA Quadro P2200 or PNY Quadro RTX A2000 (4x mDP)	<ul style="list-style-type: none"> <li>• CAD Applications</li> <li>• Content Creation</li> <li>• 3D Workstation</li> </ul>
<b>Video Capture Card</b> e.g. with 4x SDI/BNC	<ul style="list-style-type: none"> <li>• Multi-channel Capture System</li> </ul>
<b>Special Network Card</b> e.g. Multiport or 10 Gbps	<ul style="list-style-type: none"> <li>• Proxy and Firewall Applications</li> <li>• Intranet Server</li> </ul>
<b>Fieldbus Card</b> e.g. EtherCAT, Profibus, CAN, Modbus, etc.	<ul style="list-style-type: none"> <li>• Industry Automation</li> <li>• Conveyor Technology</li> <li>• Building Automation</li> </ul>
<b>Multi I/O Card</b> e.g. 8x COM-Port, DA/AD converter, general-purpose input/output (GPIO)	<ul style="list-style-type: none"> <li>• Point of Sales (POS)</li> <li>• Vending Machine</li> <li>• Automation / Control System</li> </ul>
<b>Receiver Card</b> e.g. for SAT, DVB-T2, Cable	<ul style="list-style-type: none"> <li>• Home Entertainment</li> </ul>



## Front and Back Panel

Front panel



1. 2x USB 2.0 port
2. 2x USB 3.2 Gen 1 port (blue)
3. Microphone input
4. Headphones output
5. Power button with Power LED indicator
6. LED indicator for storage activity

Back panel



7. 2x Thumbscrew
8. 2x WLAN perforation
9. Hole for Kensington Lock
10. PCI-Express X1 expansion slot
11. PCI-Express X16 expansion slot
12. Perforation for optional COM port
13. HDMI port
14. DisplayPort
15. RJ45 Gigabit LAN port
16. 2x USB 3.2 Gen 1 port (blue)
17. 2x USB 2.0 port
18. DC-in connector for power adapter
19. 4-pin connector (2.54 mm pitch) for external power button, Clear CMOS button and 5V DC voltage

Top View



Bottom View

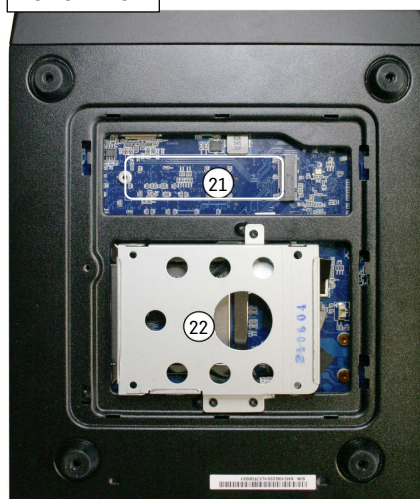

20. Installed heatpipe cooling system
21. M.2-2280 slot for one SATA SSD module
22. Storage bay for 2.5" drive with SATA port

## Mainboard

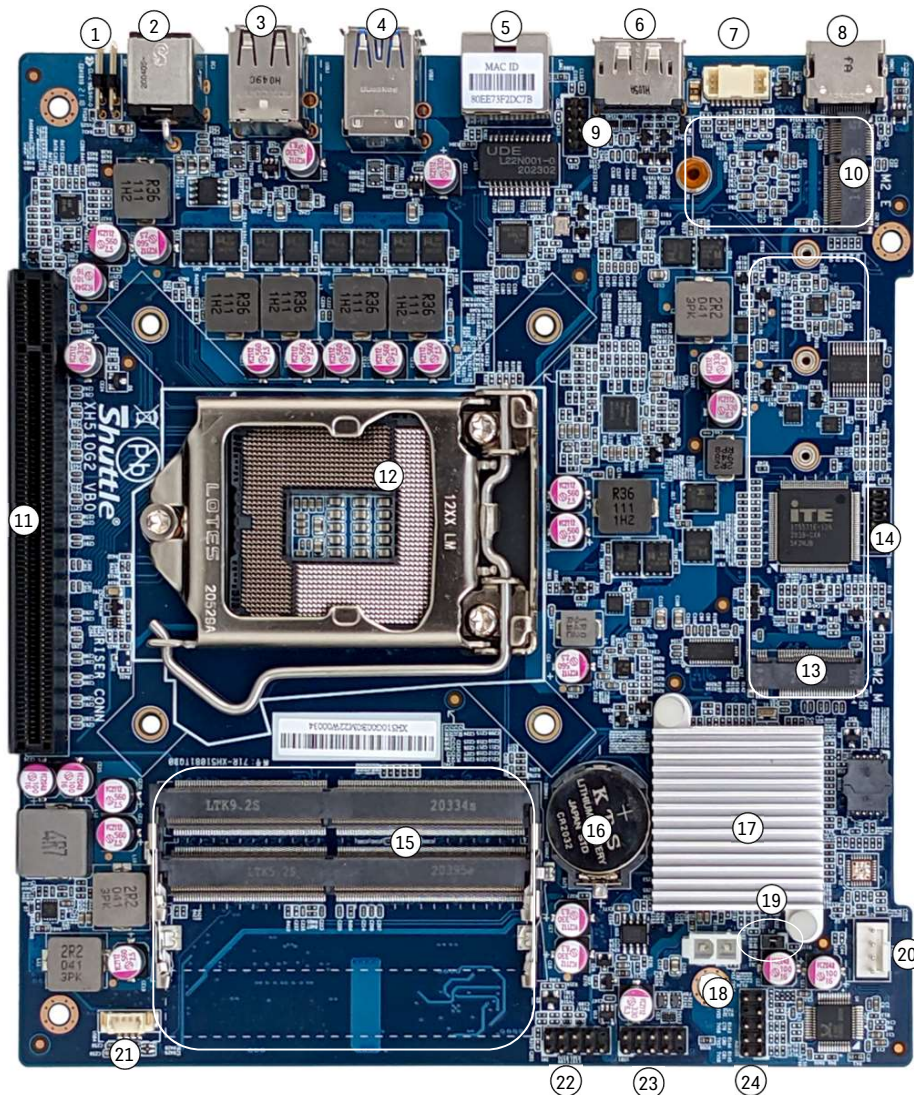







Rear View



- |  |   |
|--|---|
| <ol style="list-style-type: none"> <li>1. 4-pin connector (2.54 mm pitch) for external power button, Clear CMOS button and 5V DC voltage</li> <li>2. DC-in connector for power adapter</li> <li>3. 2x USB 2.0 port</li> <li>4. 2x USB 3.2 Gen 1 port</li> <li>5. RJ45 Gigabit LAN port</li> <li>6. DisplayPort</li> <li>7. Onboard VGA port (analog)</li> <li>8. HDMI port</li> <li>9. Onboard COM port supports RS232</li> <li>10. M.2-2230E slot for WLAN card</li> <li>11. PCI-Express X16 slot</li> <li>12. LGA1200 processor socket</li> <li>13. M.2-2280M slot for SSD card</li> </ol> | <ol style="list-style-type: none"> <li>14. Debug header (reserved)</li> <li>15. 2x SO-DIMM memory slot</li> <li>16. CMOS battery</li> <li>17. Intel H510 chipset with heat sink</li> <li>18. 5V power supply connector</li> <li>19. Always-Power-On jumper</li> <li>20. 4-pin connector for cooling fan</li> <li>21. 4-pin USB 2.0 connector (for optional WWN03 accessory)</li> <li>22. Front panel power button and LED connector</li> <li>23. Front panel USB 2.0 connector</li> <li>24. Front panel Audio connector</li> <li>25. SATA v3.0 connector</li> <li>26. M.2-2280 slot for a SATA SSD module</li> <li>27. Front panel USB 3.0 connector</li> </ol> |
|--|---|



## Shuttle Product Comparison: XH410G versus XH510G / XH510G2

MODEL	XH410G	XH510G	XH510G2
Processor Support	10 <sup>th</sup> Gen. Intel Core Processors "Comet Lake-S" Socket LGA1200, TDP max. 65W	10 <sup>th</sup> / 11 <sup>th</sup> Gen. Intel Core Processors "Comet Lake-S" and "Rocket Lake-S" Socket LGA1200, TDP max. 65W	
Operating System Support	Windows 10 & Linux – 64-bit		Windows 10 & Linux – 64-bit
Chipset	Intel H410	Intel H510	
Memory (max.)	2x 32 GB DDR4-2666/2933 SO-DIMM (260 pins)	2x 32 GB DDR4-2666/2933/3200 *) SO-DIMM (260 pins)	
Drive Bays	1x 2.5" bay (SATA v3.0) Max. 9.5 mm height	1x 2.5" bay (SATA v3.0) Max. 9.5 mm height	
PCI-Express Slot(s)	Single Slot: 1x PCI-Express v3.0 X16 Max. length/width: 208/30 mm Max. TDP: 75 W	Single Slot: 1x PCI-Express v3.0/v4.0 X16 Max. length/width: 208/30 mm Max. TDP: 75 W	Dual Slot: 1x PCI-Express v3.0/v4.0 X16 *) Max. length: 208 mm Max. TDP: 75 W 1x PCI-Express v3.0 X1
M.2 Slots	M.2-2280M (for PCIe or SATA SSDs) M.2-2230E (for WLAN modules)	M.2-2280M (for PCIe or SATA SSDs) M.2-2230E (for WLAN modules)	
Front Panel Ports	2x USB 3.2 Gen 1 2x USB 2.0 2x Audio Power-Button Power-LED, HDD-LED	2x USB 3.2 Gen 1 2x USB 2.0 2x Audio Power-Button Power-LED, HDD-LED	
Back Panel Ports	HDMI 2.0a + D-Sub/VGA 2x USB 3.2 Gen 1 + 2x USB 2.0 Gigabit LAN Connector for ext. Power Button Optional RS232 COM port DC input	HDMI 2.0a/1.4b*) + DisplayPort 1.4 2x USB 3.2 Gen 1 + 2x USB 2.0 Gigabit LAN Connector for ext. Power Button Optional COM <b>oder</b> VGA port DC input	
Internal Ports and Jumpers	USB 2.0 Type A (for USB stick) Always-power-on-Jumper 5V power output connector (2-pin)	Always-power-on-Jumper 5V power output connector (2-pin)	
Power Adapter	180 W / 19.5 V	180 W / 19.5 V	
Optional Accessories	WLAN kit (WLN-M/-M1) Power Button cable (CXP01) COM port adapter (PCP11) Vertical stand (PS01)	WLAN kit (WLN-M/-M1) LTE/4G-Kit (WWN03) Power Button cable (CXP01) COM port adapter (PCP11) **) D-Sub/VGA port adapter (PVG01) **) Vertical stand (PS01)	WLAN kit (WLN-M/-M1) LTE/4G-Kit (WWN03) Power Button cable (CXP01) COM port adapter (PCP11) **) D-Sub/VGA port adapter (PVG01) **)
Chassis Dimensions	25 x 20 x 7.85 cm (3.9 L)	25 x 20 x 7.85 cm (3.9 L)	25 x 20 x 9.5 cm (4.75 L)
Front View			
Back View			

\*) DDR4-3200, PCI-Express X16 v4 and HDMI 2.0a is only supported with Gen 11 "Rocket Lake-S" Processor

\*\*) The Accessories CXP01 (COM port) and PVG01 (VGA port) cannot be used at the same time

## SHUTTLE XPC SLIM BAREBONE XH510G2 – SPECIFICATIONS

CHASSIS	<p>Slim X-type chassis, colour: black</p> <p>Dimensions: 250 x 200 x 95 mm (LWH)</p> <p>Weight: 2.98 kg net, 3.49 kg gross</p> <p>Open front - no concealed front panel connectors</p> <p>Hole for Kensington Lock at the backpanel</p>
OPERATING POSITION	<p>(1) horizontal on its feet</p> <p>(2) vertical with the supplied VESA mount bracket</p>
POWER ADAPTER	<p>External 180 W power adapter (fanless)</p> <p>Input: 100~240 V AC, 50~60 Hz, max. 2.5 A</p> <p>Output: 19.5 V DC, max. 9.23 A, max. 180 W output wattage</p> <p>AC Connector with protective-earth contacts, cable length: 1.7 m</p> <p>DC Connector: 5.5 / 2.5 mm (outer/inner diameter)</p> <p>Dimensions: ca. 167 x 82 x 25.5 mm = 350 ml</p>
OPERATING SYSTEM	<p>This system comes without an operating system.</p> <p>It is compatible with Windows 10, Windows 11 and Linux (64-bit)</p>
PROCESSOR SUPPORT	<p>Processor Socket LGA1200</p> <p>Supports Intel Core i9 / i7 / i5 / i3, Pentium Gold and Celeron processors</p> <p>Supports 10<sup>th</sup> and 11<sup>th</sup> generation Intel Core processors, codenamed "Comet Lake-S" and "Rocket Lake-S" in 14 nm process technology</p> <p>Maximum supported processor power consumption (TDP) = 65 W</p> <p>Up to 10 CPU cores, 20 threads and 20 MB of L3 cache</p> <p>Does not support the unlock-function of Intel K-Series processors.</p> <p>The processor integrates PCI-Express, RAM controller and the graphics engine (Performance features depend on processor type <b>[6]</b>)</p> <p>Please refer to the support list for detailed processor support information at <a href="https://global.shuttle.com">global.shuttle.com</a>.</p> <p><u>Not compatible</u> with older Socket LGA 1151(v2) processors.</p>
PROCESSOR COOLING	<p>Processor cooling with heatpipe technology and two fans (60 mm)</p>
MAINBOARD / CHIPSET	<p>Mainboard in a Shuttle form factor proprietary design for the XPC XH510G2</p> <p>Chipset/Southbridge: Intel® H510</p> <p>Passive chipset cooling with heat sink</p> <p>The Northbridge is integrated in the processor.</p> <p>Solid Capacitors for sensitive areas provide excellent heat resistance for enhanced system durability</p>
BIOS	<p>AMI BIOS, SPI Interface, 16 MB Flash-EEPROM</p> <p>Supports Hardware Monitoring and Watchdog functionality</p> <p>Supports Firmware-TPM (fTPM) v2.0 <b>[5]</b></p> <p>Supports boot up from external USB flash memory</p> <p>Supports Unified Extensible Firmware Interface (UEFI)</p> <p>Supports power on after power failure <b>[1]</b></p>
MEMORY SUPPORT	<p>2x SO-DIMM slot with 260 pins</p> <p>The <u>maximum DDR4 clock frequency</u> depends on the processor type used:</p> <ul style="list-style-type: none"> <li>- Gen. 11 "Rocket Lake" supports DDR4-3200 (PC4-25600U)</li> <li>- Gen. 10 "Comet Lake" Core i7/i9 supports DDR4-2933 (PC4-23433U)</li> <li>- other Gen. 10 "Comet Lake" support DDR4-2666 (PC4-21300U)</li> </ul> <p>Supports Dual Channel mode</p> <p>Supports a maximum of 32 GB per DIMM, maximum total size: 64 GB</p> <p>Supports two unbuffered DIMM modules (no ECC or registered)</p>
INTEGRATED GRAPHICS	<p>The features of the integrated Intel UHD graphics function depend on the processor type used. <b>[6]</b></p> <p>The PC features two video outputs:</p> <ul style="list-style-type: none"> <li>- HDMI v2.0a (only HDMI v1.4b with Gen. 10 "Comet Lake" processors)</li> <li>- DisplayPort v1.4</li> </ul> <p>Both outputs support displays with 4K Ultra HD resolution at 3840 x 2160 with 60 Hz refresh rate (2160p60) and support multi-channel digital audio over the same cable (HDMI 1.4b support Ultra HD with 30 Hz only).</p> <p>Supports two independent displays with the integrated graphics function</p> <p>Optional analog D-Sub/VGA video output <b>[4]</b></p>



<b>TWO PCIe EXPANSION SLOTS</b>	<p>The pre-installed 90° Riser Card provides two PCI-Express expansion slots:            1x PCI-Express X16 v4.0 slot            (only PCIe v3.0 with Gen. 10 "Comet Lake" processors)            1x PCI-Express X1 v3.0 slot</p> <p>Supports dual-slot (double-width) graphics cards (occupies the second PCI-Express slot)            The used PCIe X16 expansion card must meet the following conditions:            1) Maximum dimensions: 208 mm x 120 mm x 45 mm            2) Maximum power consumption: 75 W</p> <p>For special purposes, the mainboard provides a 5V auxiliary voltage (max. 2 A) via 4-pin Molex connector.</p>
<b>AUDIO</b>	<p>Audio Realtek® ALC662/897/888 High-Definition Audio            Two analog audio connectors (3.5 mm) at the front panel:            (1) Microphone input            (2) Headphones output (Line out)            Digital 7.1 audio output: possible via the HDMI and DisplayPort connectors</p>
<b>GIGABIT LAN</b>	<p>Intel i219LM network controller            Supports 10 / 100 / 1.000 MBit/s operation            Supports WAKE ON LAN (WOL)            Supports network boot by Preboot eXecution Environment (PXE)</p>
<b>2.5" STORAGE BAY</b>	<p>This system features one 2.5" drive bay which is accessible from the bottom of the housing.            It supports one 2.5" / 6.35 cm hard disk or SSD with max. 9.5 mm height.            The system includes a pre-installed data/power cable <b>[3]</b>.            The connector supports SATA III with max. 6 Gbps.</p>
<b>TWO M.2 SLOTS FOR SSD CARDS</b>	<p>This system features two M.2-2280M slots.            Both M.2 slots support M.2 cards with key M or key B+M.            Both M.2 slots support SSD cards with SATA interface.            One of the slots also supports SSDs with PCI Express interface and NVMe support.</p> <p><b>M.2-Slot 1:</b></p> <ul style="list-style-type: none"> <li>- is located inside the housing</li> <li>- supports M.2 cards with a length of 80, 60 or 80 mm (type 2242, 2260, 2280)</li> <li>- supports SATA v3.0 (6 Gbps) or PCIe v3.0 X4 (NVMe)</li> </ul> <p><b>M.2-Slot 2:</b></p> <ul style="list-style-type: none"> <li>- is accessible from the bottom of the housing</li> <li>- supports M.2 cards with a length of 80 mm (type 2280)</li> <li>- supports SATA v3.0 (6 Gbps)</li> </ul>
<b>M.2-2230E SLOT</b>	<p>The M.2 2230E slot has the following interfaces:            - PCI-Express v2.0 X1            - USB 2.0</p> <p>It supports M.2 cards with a width of 22 mm and a length of 30 mm. This slot is intended for Wireless LAN (Wifi) cards.</p>
<b>FRONT PANEL CONNECTORS</b>	<p>1x Microphone input (3.5 mm)            1x Headphones output (3.5 mm, line out)            2x USB 3.2 Gen 1 (blue, max. 5 Gbps)            2x USB 2.0            1x Power button with Power LED (blue)            1x HDD LED (yellow)</p>
<b>BACK PANEL CONNECTORS</b>	<p>1x HDMI 2.0a supports screw lock            (supports only HDMI v1.4b with Gen. 10 "Comet Lake" processors)            1x DisplayPort 1.4            2x USB 3.2 Gen 1 (blue, max. 5 Gbps)            2x USB 2.0            1x GigaBit LAN (RJ45, Intel i219LM)            1x DC-input connector for external power adapter (supports 19.5 V)            1x 4-pin connector (2.54 mm pitch) supports:            - external power on button            - Clear CMOS function            - +5V DC voltage for external components</p> <p>1x perforation for optional VGA or COM port <b>[4]</b>            2x perforation for optional Wireless LAN antennas            1x hole for Kensington Lock</p>

OTHER ONBOARD CONNECTORS	<p>2-pin onboard ATX connector with 5V (max. 2 A) output voltage with 4-pin Molex adapter cable</p> <p>Power-on-after-power-fail (hardware solution by jumper) <b>[1]</b></p> <p>RS232 COM port (2x5-pin header, 2 mm pitch)</p> <p>Front connector for power button, LEDs, USBs, audio ports</p> <p>4-pin fan connectors (occupied by the CPU cooling system)</p> <p>4-pin USB 2.0 connector (for the optional WWN03 accessory)</p> <p>2x 5-pin debug port</p>
SUPPLIED ACCESSORIES	<p>Multi-language installation guide (EN, DE, FR, ES, JP, KR, SC, TC)</p> <p>Driver DVD</p> <p>Bracket for one 2.5" drive</p> <p>Four screws M3 x 4 mm (to mount a 2.5" storage device into the bay/bracket)</p> <p>Three screws M2 x 5 mm (to mount the drive bracket)</p> <p>VESA mount brackets (2 parts, metal) supports 75x75 and 100x100 mm VESA standard</p> <p>Four screws M3 x 5 mm (screws together VESA mount and PC)</p> <p>Four screws M4 x 10 mm (to affix VESA mount on the PC)</p> <p>Three screws M3 x 5 mm (silver colour, to mount up to three M.2 cards)</p> <p>Internal adapter cable with 4-pin Molex connector for 5V/2A auxiliary voltage</p> <p>External power adapter with 1.7 m power cord with earthing contact</p> <p>Protector cap for the CPU socket (do not use if heat-pipe or fan is mounted)</p> <p>CPU heatpipe cooling system with heatsink compound</p>
OPTIONAL ACCESSORIES	<p><b>WLN-M:</b> WLAN module supports WLAN and Bluetooth, with two external antennas</p> <p><b>WWN03:</b> LTE adapter kit with antennas, but without LTE card <b>[7]</b></p> <p><b>PCP11:</b> Backpanel COM port adapter for RS232 serial interface <b>[4]</b></p> <p><b>PVG01:</b> optional D-Sub VGA video output <b>[4]</b></p> <p><b>CXP01:</b> Adapter cable for external power button</p>
ENVIRONMENTAL SPECIFICATIONS	<p>Operating temperature range: 0~50 °C <b>[2]</b></p> <p>Relative humidity range: 10~90 % (non-condensing)</p>
CERTIFICATIONS / COMPLIANCE	<p>EMI: CE, FCC, BSMI, VCCI, RCM</p> <p>Safety: CB, cTUVus, BSMI</p> <p>Other: RoHS, Energy Star 5.0, ErP</p> <p>This device is classed as a technical information equipment (ITE) in class B and is intended for use in living room and office. The CE-mark approves the conformity by the EU directives:</p> <p>(1) 2004/108/EC relating to electromagnetic compatibility (EMC),</p> <p>(2) 2006/95/EC relating to Electrical Equipment designed for use within certain voltage limits (LVD),</p> <p>(3) 2009/125/EC relating to ecodesign requirements for energy-related products (ErP)</p>

## Footnotes:

### [1] Power on after power fail

The BIOS setup provides a "Power-On after Power Fail" function that can be found under "Power Management Configuration". As the name indicates, this function determines the PC's behaviour after power failure: (1) unconditional power on, (2) restore former status or (3) keep system turned off. As a matter of the nature of this function, it may fail after short power failures. This is why the XH510G2 also comes with a hardware-based solution. By removing Jumper JP1 (located in a corner of the mainboard near the DIMM sockets) the system will start unconditionally once power is supplied.

### [2] High ambient temperature

For high ambient temperature over 40 °C we strongly recommend to use SSDs instead of hard disk drives.

### [3] Power connector for SATA drives

The supplied power cable for a SATA drive provides a voltage of 5 V. In very rare cases a 2.5" hard disk also requires a 12 V line. This is not supported.

### [4] Optional VGA or COM port

At the back panel is a perforation for optional installation of a D-Sub connection - either an analog VGA port (adapter PVG01) or a serial RS232 port (adapter PCP11). The required adapter is not included in the scope of delivery and can be purchased as a Shuttle accessory item. Note: With the installation of a VGA connector, three monitor ports are available, but only two of them can be used simultaneously.

### [5] TPM Function

This product features Firmware-TPM (fTPM) v2.0. Besides, it is prepared for a hardware TPM chip which can be fitted by factory on request.

**[6] Intel processors without integrated graphics** can be identified by their model name ending on "F", e.g. Core i7-10700F. When using this CPU, a graphics card is required.

### [7] Optional Accessory WWN03 (LTE kit)

The Shuttle XPC accessory WWN03 allows this PC to be upgraded with an LTE/4G function for mobile network. The adapter board of WWN03 is screwed to the XH510G2 chassis from the inside and connected to an onboard USB header. The required LTE/4G card in M.2-3042 format and an activated Nano SIM card is not included in the scope of delivery.

### XH510G2 with VESA mount (drawing)

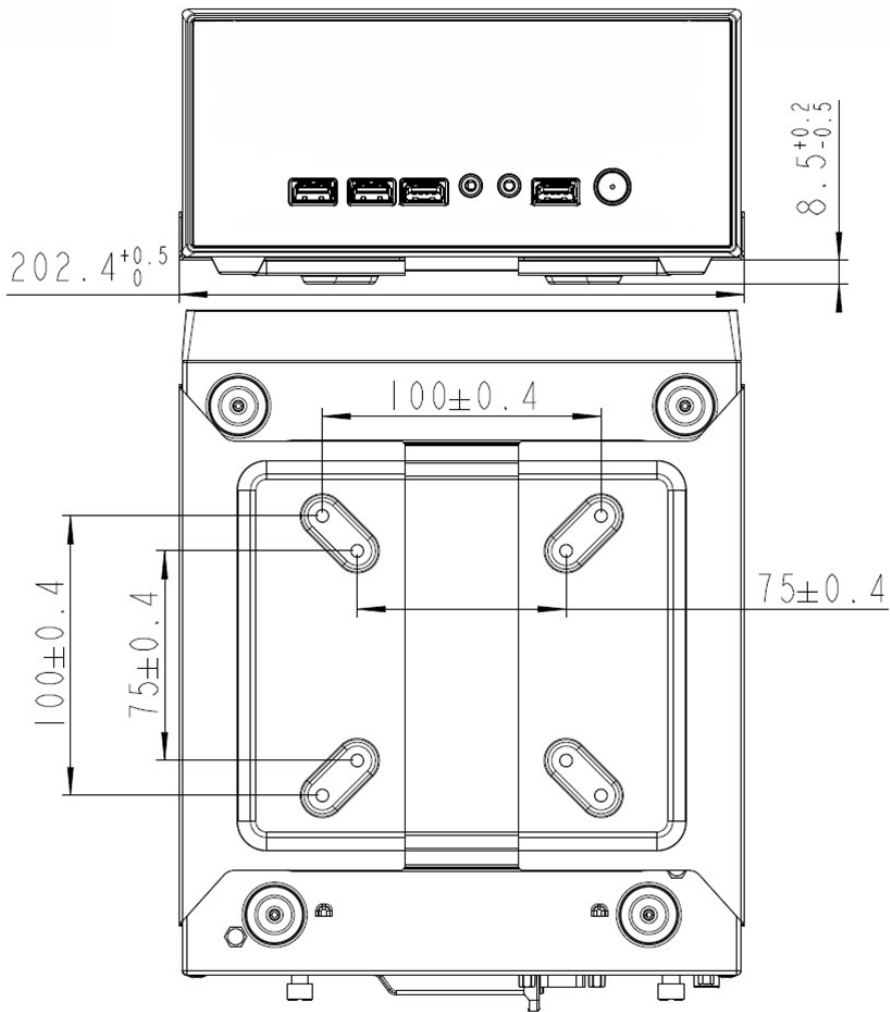



## 10<sup>TH</sup> GENERATION INTEL CORE DESKTOP PROCESSOR FAMILY

Socket LGA1200 14 nm "Comet Lake S" and "Comet Lake Refresh" processor overview (Date: November 2021)

Processors with a TDP of more than 65W are **not supported (marked in red)**.

PROCESSOR	MODEL	CORES/ THREADS	CPU CLOCK	TURBO BOOST CLOCK (2.0)	SMART CACHE	TDP	MEMORY SUPPORT	GRAPHICS ENGINE
Core™ i9	<b>10900K</b>	10/20	3.7 GHz	5.1 GHz	20 MB	125 W	DDR4-2933	UHD 630 (1.2 GHz)
	<b>10900KF</b>	10/20	3.7 GHz	5.1 GHz	20 MB	125 W	DDR4-2933	None
	10900	10/20	2.8 GHz	5.0 GHz	20 MB	65 W	DDR4-2933	UHD 630 (1.2 GHz)
	10900F	10/20	2.8 GHz	5.0 GHz	20 MB	65 W	DDR4-2933	None
	10900T	10/20	1.9 GHz	4.5 GHz	20 MB	35 W	DDR4-2933	UHD 630 (1.2 GHz)
Core™ i7	<b>10850K</b>	10/20	3.6 GHz	5.0 GHz	20 MB	125 W	DDR4-2933	UHD 630 (1.2 GHz)
	<b>10700K</b>	8/16	3.8 GHz	5.0 GHz	16 MB	125 W	DDR4-2933	UHD 630 (1.2 GHz)
	<b>10700KF</b>	8/16	3.8 GHz	5.0 GHz	16 MB	125 W	DDR4-2933	None
	10700	8/16	2.9 GHz	4.7 GHz	16 MB	65 W	DDR4-2933	UHD 630 (1.2 GHz)
	10700F	8/16	2.9 GHz	4.7 GHz	16 MB	65 W	DDR4-2933	None
Core™ i5	10700T	8/16	2.0 GHz	4.4 GHz	16 MB	35 W	DDR4-2933	UHD 630 (1.2 GHz)
	<b>10600K</b>	6/12	4.1 GHz	4.8 GHz	12 MB	125 W	DDR4-2666	UHD 630 (1.2 GHz)
	<b>10600KF</b>	6/12	4.1 GHz	4.8 GHz	12 MB	125 W	DDR4-2666	None
	10600	6/12	3.3 GHz	4.8 GHz	12 MB	65 W	DDR4-2666	UHD 630 (1.2 GHz)
	10600T	6/12	2.4 GHz	4.0 GHz	12 MB	35 W	DDR4-2666	UHD 630 (1.2 GHz)
	10505	6/12	3.2 GHz	4.6 GHz	12 MB	65 W	DDR4-2666	UHD 630 (1.2 GHz)
	10500	6/12	3.1 GHz	4.5 GHz	12 MB	65 W	DDR4-2666	UHD 630 (1.15 GHz)
	10500T	6/12	2.3 GHz	3.8 GHz	12 MB	35 W	DDR4-2666	UHD 630 (1.1 GHz)
	10400	6/12	2.9 GHz	4.3 GHz	12 MB	65 W	DDR4-2666	UHD 630 (1.1 GHz)
	10400F	6/12	2.9 GHz	4.3 GHz	12 MB	65 W	DDR4-2666	None
Core™ i3	10400T	6/12	2.0 GHz	3.6 GHz	12 MB	35 W	DDR4-2666	UHD 630 (1.1 GHz)
	10325	4/8	3.9 GHz	4.7 GHz	8 MB	65 W	DDR4-2666	UHD 630 (1.15 GHz)
	10320	4/8	3.8 GHz	4.6 GHz	8 MB	65 W	DDR4-2666	UHD 630 (1.15 GHz)
	10305	4/8	3.8 GHz	4.5 GHz	8 MB	65 W	DDR4-2666	UHD 630 (1.15 GHz)
	10305T	4/8	3.8 GHz	4.5 GHz	8 MB	65 W	DDR4-2666	UHD 630 (1.1 GHz)
	10300	4/8	3.7 GHz	4.4 GHz	8 MB	65 W	DDR4-2666	UHD 630 (1.15 GHz)
	10300T	4/8	3.0 GHz	3.9 GHz	8 MB	35 W	DDR4-2666	UHD 630 (1.1 GHz)
	10105F	4/8	3.7 GHz	4.4 GHz	6 MB	65 W	DDR4-2666	None
	10105	4/8	3.7 GHz	4.4 GHz	6 MB	65 W	DDR4-2666	UHD 630 (1.1 GHz)
	10105T	4/8	3.0 GHz	3.9 GHz	6 MB	35 W	DDR4-2666	UHD 630 (1.1 GHz)
	10100	4/8	3.6 GHz	4.3 GHz	6 MB	65 W	DDR4-2666	UHD 630 (1.1 GHz)
	10100F	4/8	3.6 GHz	4.3 GHz	6 MB	65 W	DDR4-2666	None
Pentium® Gold	10100T	4/8	3.0 GHz	3.8 GHz	6 MB	35 W	DDR4-2666	UHD 630 (1.1 GHz)
	G6605	2/4	4.3 GHz	-	4 MB	58 W	DDR4-2666	UHD 630 (1.1 GHz)
	G6600	2/4	4.2 GHz	-	4 MB	58 W	DDR4-2666	UHD 630 (1.1 GHz)
	G6505	2/4	4.2 GHz	-	4 MB	58 W	DDR4-2666	UHD 630 (1.1 GHz)
	G6500	2/4	4.1 GHz	-	4 MB	58 W	DDR4-2666	UHD 630 (1.1 GHz)
	G6500T	2/4	3.5 GHz	-	4 MB	35 W	DDR4-2666	UHD 630 (1.05 GHz)
	G6405	2/4	4.1 GHz	-	4 MB	58 W	DDR4-2666	UHD 610 (1.05 GHz)
	G6405T	2/4	3.5 GHz	-	4 MB	35 W	DDR4-2666	UHD 610 (1.05 GHz)
	G6400	2/4	4.0 GHz	-	4 MB	58 W	DDR4-2666	UHD 610 (1.05 GHz)
G6400T	2/4	3.4 GHz	-	4 MB	35 W	DDR4-2666	UHD 610 (1.05 GHz)	

PROCESSOR	MODEL	CORES/ THREADS	CPU CLOCK	TURBO BOOST CLOCK (2.0)	SMART CACHE	TDP	MEMORY SUPPORT	GRAPHICS ENGINE
Celeron®	G5925	2/2	3.6 GHz	-	4 MB	58 W	DDR4-2666	UHD 610 (1.05 GHz)
	G5920	2/2	3.5 GHz	-	2 MB	58 W	DDR4-2666	UHD 610 (1.05 GHz)
	G5905	2/2	3.5 GHz	-	4 MB	58 W	DDR4-2666	UHD 610 (1.05 GHz)
	G5905T	2/2	3.3 GHz	-	4 MB	35 W	DDR4-2666	UHD 610 (1.05 GHz)
	G5900	2/2	3.4 GHz	-	2 MB	58 W	DDR4-2666	UHD 610 (1.05 GHz)
	G5900T	2/2	3.2 GHz	-	2 MB	35 W	DDR4-2666	UHD 610 (1.05 GHz)

**K = unlocked, T = Power optimized lifestyle, F = without integrated graphics, TDP = Thermal Design Power (max. Power Consumption).**

Note: The Shuttle XPC slim Barebone XH510G2 does not support the Unlock-function of Intel K-Series processors.

Intel processors without integrated graphics can be identified by their model name ending on "F". When using this CPU, a graphics card is required. Please refer to the support list for detailed processor support information at [global.shuttle.com](http://global.shuttle.com).

## 11<sup>TH</sup> GENERATION INTEL CORE DESKTOP PROCESSOR FAMILY

Socket LGA1200 14 nm "Rocket Lake S" processor overview (Date: November 2021)

Processors with a TDP of more than 65W are **not supported (marked in red)**.

PROCESSOR	MODEL	CORES/ THREADS	CPU CLOCK	TURBO BOOST CLOCK (2.0)	SMART CACHE	TDP	MEMORY SUPPORT	GRAPHICS ENGINE MAX. CLOCK
Core™ i9	11900K	8/16	3.5 GHz	5.3 GHz	16 MB	125 W	DDR4-3200	UHD 750 (1.3 GHz)
	11900KF	8/16	3.5 GHz	5.3 GHz	16 MB	125 W	DDR4-3200	None
	11900	8/16	2.5 GHz	5.2 GHz	16 MB	65 W	DDR4-3200	UHD 750 (1.3 GHz)
	11900F	8/16	2.5 GHz	5.2 GHz	16 MB	65 W	DDR4-3200	None
	11900T	8/16	1.5 GHz	4.9 GHz	16 MB	35 W	DDR4-3200	UHD 750 (1.3 GHz)
Core™ i7	11700K	8/16	3.6 GHz	5.0 GHz	16 MB	125 W	DDR4-3200	UHD 750 (1.3 GHz)
	11700KF	8/16	3.6 GHz	5.0 GHz	16 MB	125 W	DDR4-3200	None
	11700	8/16	2.5 GHz	4.9 GHz	16 MB	65 W	DDR4-3200	UHD 750 (1.3 GHz)
	11700F	8/16	2.5 GHz	4.9 GHz	16 MB	65 W	DDR4-3200	None
Core™ i5	11700T	8/16	1.4 GHz	4.6 GHz	16 MB	35 W	DDR4-3200	UHD 750 (1.3 GHz)
	11600K	6/12	3.9 GHz	4.9 GHz	12 MB	125 W	DDR4-3200	UHD 750 (1.3 GHz)
	11600KF	6/12	3.9 GHz	4.9 GHz	12 MB	125 W	DDR4-3200	None
	11600	6/12	2.8 GHz	4.8 GHz	12 MB	65 W	DDR4-3200	UHD 750 (1.3 GHz)
	11600T	6/12	1.7 GHz	4.1 GHz	12 MB	35 W	DDR4-3200	UHD 750 (1.3 GHz)
	11500K	6/12	3,9 GHz	4.9 GHz	12 MB	95 W	DDR4-3200	UHD 750 (1.3 GHz)
	11500	6/12	2.7 GHz	4.6 GHz	12 MB	65 W	DDR4-3200	UHD 750 (1.3 GHz)
	11500T	6/12	1.5 GHz	3.9 GHz	12 MB	35 W	DDR4-3200	UHD 750 (1.2 GHz)
	11400	6/12	2.6 GHz	4.4 GHz	12 MB	65 W	DDR4-3200	UHD 730 (1.3 GHz)
	11400F	6/12	2.6 GHz	4.4 GHz	12 MB	65 W	DDR4-3200	None
11400T	6/12	1.3 GHz	3.7 GHz	12 MB	35 W	DDR4-3200	UHD 730 (1.2 GHz)	

**K = unlocked, T = Power optimized lifestyle, F = without integrated graphics, TDP = Thermal Design Power (max. Power Consumption).**

Note: The Shuttle XPC slim Barebone XH510G2 does not support the Unlock-function of Intel K-Series processors.

Intel processors without integrated graphics can be identified by their model name ending on "F". When using this CPU, a graphics card is required. Please refer to the support list for detailed processor support information at [global.shuttle.com](http://global.shuttle.com).