

ARGB

LIQMAX III

ARGB VERSION

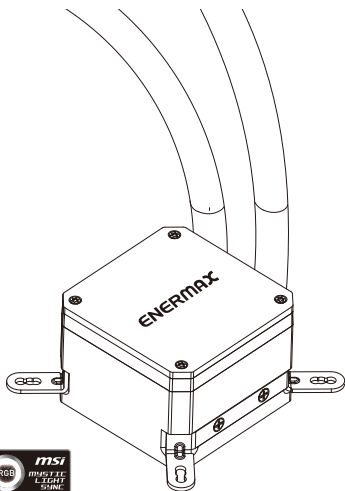
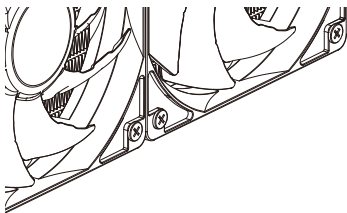

120 | 240 | 280 | 360 mm



User's Manual

Index

Limited Warranty	2
Warranty & Support information for Australia	3
Specification	4
Part List	5
Intel® Installation	9
AMD® Installation	19

Limited Warranty

Please read this limited warranty carefully. Warranty is subject to void under following criteria:

1. The serial number label or warranty seal is defaced, modified, or removed.
2. Taking apart of the product and/or modification of any component or cable without ENERMAX's written authorization.
3. Ignoring connector's faulty-insertion-prevention design by attaching a connector to a device under incorrect orientation.
4. Damage caused by natural phenomena or uncontrollable forces, such as lightning, flooding, fire, earthquake, or misuse, abuse, negligence, accident, wear and tear, mishandling, misapplication.
5. ENERMAX is only liable for limited warranty service of ENERMAX product. ENERMAX is not liable for other damage or loss of time, interest, commercial opportunity due to using defect product of ENERMAX.

This ENERMAX Technology Corporation product is warranted to be free from defects in material and workmanship for a period of two (2) years from the date of purchase. ENERMAX Technology Corporation agrees to repair or replace the product, at its own option and at no charge, if, during the warranty period, it is returned to nearest ENERMAX Technology Corporation subsidiary/agent with all shipping charges prepaid and if inspection reveals that the product is defective. Please present the proof of purchase for requesting RMA. Charges for removing or installing the product are excluded under the terms of this warranty agreement. This warranty shall not apply to any product, which has been subject to connection to a faulty power source, alteration, negligence, or accident, or to any product, which has been installed other than in accordance with these instructions. In no event shall ENERMAX Technology Corporation, or its subsidiaries, or agents be liable for damages for a breach of warranty in an amount exceeding the purchase price of this product.

If you are uncertain whether or not your ENERMAX liquid cooler is defective, please contact your dealer/reseller for support!

Web Site: <http://www.enermax.com>

E-mail: enermax@enermax.com.tw

ENERMAX Technology Corporation, 15F-2, No. 888, Jing-Guo Road, Taoyuan City (330), Taiwan (R.O.C.), Tel. +886-3-316-1675, Fax. +886-3-346-6640

©2019 ENERMAX Technology Corporation. All rights reserved. Specifications are subject to change without prior notice. Actual product and accessories may differ from illustrations. Omissions and printing errors excepted. Content of delivery might differ in different countries or areas. Some trademarks may be claimed as the property of others. Reproduction in any manner without the written permission of ENERMAX is strictly forbidden.

Warranty & Support information For Australia

Our goods come with guarantees that cannot be excluded under the Australian Consumer Law. You are entitled to a replacement or refund for a major failure and for compensation for any other reasonably foreseeable loss or damage.

You are also entitled to have the goods repaired or replaced if the goods fail to be of acceptable quality and the failure does not amount to a major failure. Please read the above limited warranty. This warranty is valid only for the ENERMAX products distributed by authorized dealer(s) in Australia.

Please contact ENERMAX for warranty and support information.

ENERMAX Technology Corporation

15F-2, No. 888, Jing-Guo Road, Taoyuan City (330), Taiwan (R.O.C.)

Tel. +886-3-316-1675

Web Site: <http://www.enermax.com>

E-mail: enermax@enermax.com.tw

This ENERMAX liquid cooler is warranted to be free from defects in material and workmanship for period stated in two(2) years. ENERMAX Technology Corporation agrees to repair or replace the product, at its own option and at no charge, if during the warranty period, it is returned to nearest ENERMAX Technology Corporation subsidiary/agent with all shipping charges prepaid and bearing a return merchandise authorization (RMA) number, and if inspection reveals that the product is defective. Charges for removing or installing the product are excluded under the terms of this warranty agreement. This warranty shall not apply to any product, which has been subject to connection to a faulty power source, alteration, negligence, or accident, or to any product, which has been installed other than in accordance with these instructions. In no event shall ENERMAX Technology Corporation, or its subsidiaries, or agents be liable for damages for a breach of warranty in an amount exceeding the purchase price of this product!

Unless stated in the manual, the standard product warranty period is described in two(2) years. If the goods is found defective within the period of warranty from the date of purchase, please contact ENERMAX or your purchased retail shop/agent.

Please note that proof of purchase would be required when request the RMA.

Specification

Model		ELC-LMT120-ARGB	ELC-LMT240-ARGB	ELC-LMT280-ARGB	ELC-LMT360-ARGB
CPU Socket		Intel® LGA 2066/2011-3/2011/1366/1156/1155/1151/1150 AMD® AM4/AM3+/AM3/AM2+/AM2/FM2+/FM2/FM1			
Material		Copper Base with Aluminum Radiator			
Pump	Bearing	Ceramic Bearing			
	MTBF	50,000 hrs			
	Motor Speed	3100 RPM ± 10%			
	Rated Voltage	12 V			
	Rated Current - Pump	0.4 A *or 0.53A if not connected to 4 pin RGB connector (5V/D/-/G)			
Water block	Rated Current - RGB LED	0.18 A			
Radiator	Dimension	154 x 120 x 27 mm	274 x 120 x 27 mm	314 x 140 x 27 mm	394 x 120 x 27 mm
Tube	Material	Rubber			
	Length	400 mm			
Weight (W/O fan)		690 g	795 g	954 g	968 g
Fan	Dimension	120 x 120 x 25 mm			
	MTTF	50,000 hrs			
	Speed	500~1600 RPM			
	Rated Voltage	12 V			
	Rated Current - Fan	0.17 A			
	Rated Voltage - RGB LED	5V			
	Rated Current - RGB LED	0.36 A			
	Air Flow	22.5~72.1 CFM			
	Static Pressure	0.2~1.98 mm-H ₂ O			
	Noise Level	14~27 dBA			
	Connector	4 pin PWM connector 4 pin ARGB connector (5V/D/-/G)			
Thermal Grease		Dow Corning® TC-5121C			
Warranty		2 years			

* Note: An addressable RGB mainboard with 5V header is needed to provide full lighting capability. In stand-alone mode, only the water block is illuminated with the Racing-Rainbow effect.

LIQMAX III ARGB 120 - Part List

A Cooler x 1

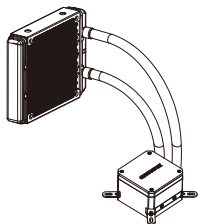

B Fan x 1



C Back Plate x 1



D Position Screw x 4



E Square Spacer x 1



F Stand-off x 4



G Case Screw x 8



H Fan Screw x 8



I Intel LGA 2011/2066 Screw x 4



J Spring Screw x 4



K Washer x 4



L Intel Clip x 1

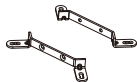

M AMD Clip x 1

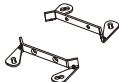

N Bracket Screw x 4



O Thermal Grease x 1



P SATA adapter x 1



Q RGB Sync cable x 1



LIQMAX III ARGB 240 - Part List

A Cooler x 1

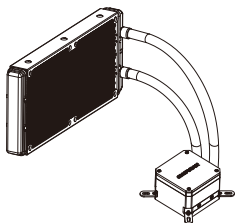

B Fan x 2



C Back Plate x 1



D Position Screw x 4



E Square Spacer x 1



F Stand-off x 4



G Case Screw x 8



H Fan Screw x 8



I Intel LGA 2011/2066
Screw x 4



J Spring Screw x 4



K Washer x 4



L Intel Clip x 1

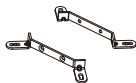

M AMD Clip x 1

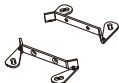

N Bracket Screw x 4



O Thermal Grease x 1



P PWM Y cable x 1

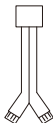

Q SATA adapter x 1



R RGB Sync cable x 1



LIQMAX III ARGB 280 - Part List

A Cooler x 1

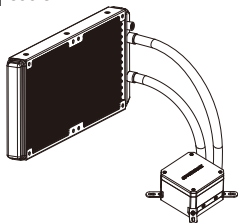

B Fan x 2



C Back Plate x 1



D Position Screw x 4



E Square Spacer x 1



F Stand-off x 4



G Case Screw x 8



H Fan Screw x 8



I Intel LGA 2011/2066
Screw x 4



J Spring Screw x 4



K Washer x 4



L Intel Clip x 1

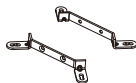

M AMD Clip x 1

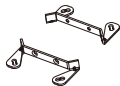

N Bracket Screw x 4



O Thermal Grease x 1



P PWM Y cable x 1

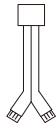

Q SATA adapter x 1



R RGB Sync cable x 1



S RGB Control Box x 1



T RGB Control Power
cable (SATA) x 1



LIQMAX III ARGB 360 - Part List

A Cooler x 1

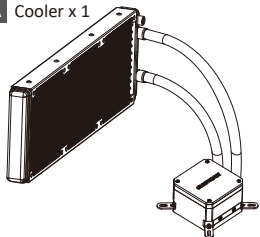

B Fan x 3



C Back Plate x 1



D Position Screw x 4



E Square Spacer x 1



F Stand-off x 4



G Case Screw x 12



H Fan Screw x 12



I Intel LGA 2011/2066
Screw x 4



J Spring Screw x 4



K Washer x 4



L Intel Clip x 1

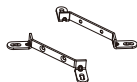

M AMD Clip x 1

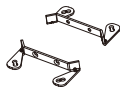

N Bracket Screw x 4



O Thermal Grease x 1



P PWM Y cable x 1



Q SATA adapter x 1



R RGB Sync cable x 1



S RGB Control Box x 1



T RGB Control Power
cable (SATA) x 1



Intel Installation

Intel Installation

Step 1

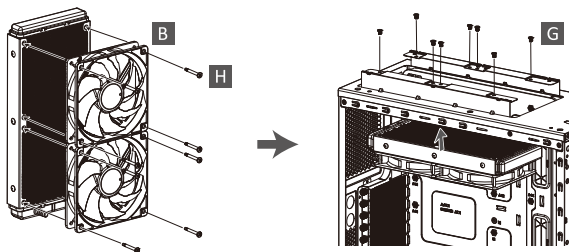

- EN** Attach the fan and the radiator to the chassis.
- DE** Schrauben Sie den Lüfter und den Radiator am Gehäuse fest.
- FR** Fixez le ventilateur et le radiateur sur le châssis.
- IT** Fissare la ventola e il radiatore al case.
- ES** Fijar el ventilador y el radiador a la caja.
- PL** Zamontuj wentylator i radiator na obudowie komputerowej.
- TW** 安裝風扇及散熱排於機殼
- CN** 将风扇以及散热排安装在机箱上
- JP** ファンをラジエーターに設置してケースに取り付けて下さい。
- KR** 팬과 방열기를 PC 케이스에 부착하십시오.
- ID** Pasang kipas dan radiator ke casing.
- RU** Закрепите вентилятор и радиатор на корпусе.

Intel Installation

Step 2

* LGA1150/1151/1155/1156/1366

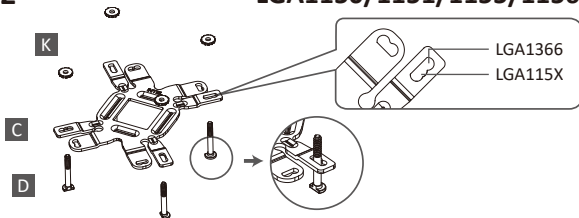

EN Insert the position screws into the proper holes on the back plate. Then use the washers to fix the position screws. 《If your CPU platform is Intel LGA2011/2011-3/2066, please skip to step 3-2》

DE Drehen Sie die Montageschrauben in die zu Ihrem Sockel passende Bohrung in der Backplate wie abgebildet an. 《Wenn Sie einen LGA2011/2011-3/2066-Sockel verwenden, gehen Sie bitte zu Schritt 3-2 über》

FR Insérez les vis de position dans les trous correspondant à votre socket du CPU sur la plaque arrière. Puis fixez-les avec les rondelles. 《S'il s'agit d'un processeur Intel LGA2011/2011-3/2066, passez à l'étape 3-2》

IT Inserire le viti di montaggio nel foro appropriato nella piastra posteriore come mostrato nella figura sotto. 《Se la piattaforma CPU è Intel LGA2011/2011-3/2066, si prega di passare al punto 3-2》

ES Inserte los tornillos de montaje en el agujero correspondiente en la placa trasera como se ve en la imagen abajo. 《Si su plataforma de CPU es Intel LGA2011/2011-3/2066, por favor vaya directamente al paso 3-2》

PL Włóż śruby pozycjonujące do odpowiednich otworów na płycie tylnej. Następnie użyj podkładek w celu zamocowania śrub pozycjonujących. 《Platformy Intel LGA2011/2011-3/2066: Proszę przejść do punktu 3-2》

TW 在背板上依系統CPU腳位所標示的孔位插入定位螺絲並套上墊圈固定
《如果您的主機板是Intel LGA2011/2011-3/2066，請直接跳至步驟3-2》

CN 在背板上根据系統CPU脚位所標示的孔位插入定位螺絲并套上墊圈固定
《如果您的主機板是Intel LGA2011/2011-3/2066，請直接跳至步驟3-2》

JP ポジションスクリューをバックプレートの適切なネジ穴に挿入し、ワッシャーを使用してポジションスクリューを固定して下さい。《Intel LGA2011/2011-3/2066をお使いの方はステップ3-2に進んでください》

KR 브라켓 구멍에 알맞은 나사를 삽입 한 후 와셔를 사용하여 나사를 고정하세요.
《CPU 플랫폼이 Intel LGA2011/2011-3/2066 인 경우, Step3-2로 가세요》

ID Masukkan sekrup ke dalam lubang yang tepat pada back plate. Kemudian gunakan washers/ring untuk mengencangkan sekrup. 《Jika Platform CPU Anda Intel LGA LGA2011/2011-3/2066, lanjutkan ke langkah 3-2》

RU Установите винты для крепежной пластины в соответствующие отверстия для вашего процессора. Установите промежуточные стойки на винты. 《Если ваша CPU платформа является Intel LGA2011/2011-3/2066, пожалуйста, перейдите к шагу номер 3-2》

Step 3-1

* LGA1150/1151/1155/1156/1366

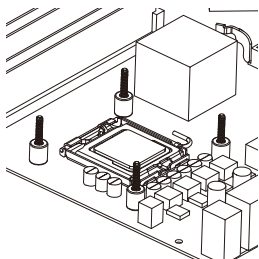
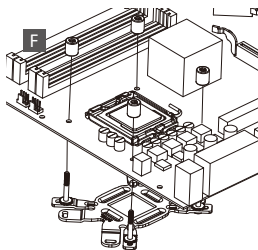

- EN** Install the Intel back plate on to the back of motherboard; fix the back plate with the stand-off.
- DE** Befestigen Sie die Intel-Backplate auf der Mainboard-Rückseite. Schrauben Sie die Backplate mit den zugehörigen Abstandshaltern fest.
- FR** Installez la plaque arrière Intel sous la carte-mère à l'aide des vis du support.
- IT** Installare la piastra posteriore Intel nella parte posteriore della scheda madre; fissare la piastra posteriore con il montante.
- ES** Instalar la placa posterior Intel en la parte posterior de la placa madre, fijar la placa posterior con el tornillo de pilar.
- PL** Umieść płytę mocującą pod płytą główną i wkręć za pomocą nakrętek mocujących.
- TW** 將Intel強化背板以套筒固定於主板背面
- CN** 將Intel強化背板以套筒固定于主板背面
- JP** Intel用バックプレートをマザーボードの裏側に配置し、専用ネジで固定して下さい。
- KR** Intel 백 플레이트를 마더보드 후면에 설치하십시오. 백 플레이트를 지지대로 고정합니다.
- ID** Pasang back plate intel pada bagian belakang motherboard, kencangkan back plate dengan stand off.
- RU** Установите крепёжную пластину «Intel» на материнской плате, затем закрепите крепёжную пластину с помощью винтов.

Step 3-2

* Intel LGA 2011/2011-3/2066

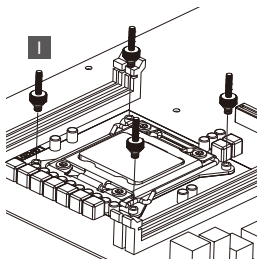

- EN** Tighten the Intel LGA2011/2011-3/2066 screw to the motherboard.
- DE** Schrauben Sie die Backplate mit den passenden LGA2011/2011-3/2066-Abstandshaltern am Mainboard fest.
- FR** Serrez la vis du support Intel LGA2011/2011-3/2066 à la carte-mère.
- IT** Fissare i montanti per Intel LGA2011/2011-3/2066 alla scheda madre.
- ES** Fije los tornillos de pilar para Intel LGA2011/2011-3/2066 a la placa madre.
- PL** Przykręć płytę mocującą za pomocą przeznaczonych do platformy LGA2011/2011-3/2066 nakrętek dystansowych.
- TW** 將LGA2011/2011-3/2066螺絲固定於主板上
- CN** 將LGA2011/2011-3/2066螺絲固定在主板的相应位置上
- JP** Intel LGA2011/2011-3/2066の場合、2011/2066専用ネジを使用しバックプレートをマザーボードに固定して下さい。
- KR** Intel LGA2011/2011-3/2066 지지대를 마더보드에 고정하십시오.
- ID** Kencangkan Intel LGA2011/2011-3/2066 sekrup ke motherboard.
- RU** Затяните гайки «Intel LGA2011/2011-3/2066» на материнской плате.

Step 4

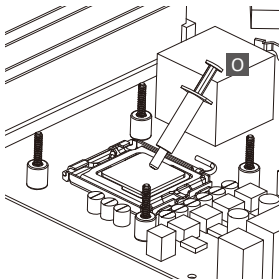

- EN** Apply the thermal grease evenly on the CPU surface.
- DE** Verteilen Sie gleichmäßig eine dünne Schicht Wärmeleitpaste auf der CPU-Oberfläche.
- FR** Appliquez une couche uniforme de pâte thermique sur la surface du CPU.
- IT** Applicare in modo uniforme la pasta termica sulla superficie della CPU.
- ES** Aplicar de forma uniforme la pasta térmica en la superficie de la CPU.
- PL** Nałóż równomiernie cienką warstwę pasty termoprzewodzącej na metalową osłonę na procesorze.
- TW** 將散熱膏均勻的塗抹於CPU表面
- CN** 请在CPU表面均与涂抹散热硅脂
- JP** サーマルグリスをCPUの表面に均一になるよう薄く塗って下さい。
- KR** CPU 표면에 구리스를 평평히 펴 바르십시오.
- ID** Oleskan secara merata thermal pasta ke permukaan CPU.
- RU** Нанесите термопасту равномерно на поверхность процессора.

Intel Installation

Step 5

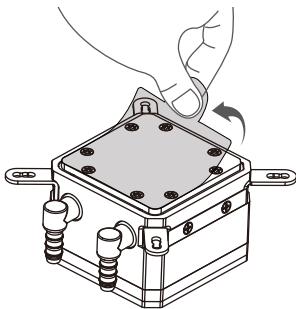

- EN** Remove the protect film from the cold-plate.
- DE** Entfernen Sie die Schutzfolie von der Kühlplatte der Pumpe.
- FR** Retirez le film protecteur de la plaque-froide.
- IT** Rimuovere la pellicola di protezione dalla piastra di raffreddamento.
- ES** Quite la película de protección del bloque de refrigeración.
- PL** Zdjąć folię ochronną z bloku wodnego.
- TW** 取下水冷頭保護貼膜
- CN** 使用时请将水冷头保护贴膜取下
- JP** コールドプレートの保護フィルムを外して下さい。
- KR** 쿨드 플레이트의 보호 필름을 제거하십시오.
- ID** Lepaskan pita pelindung dari plat pendingin.
- RU** Пожалуйста, удалите защитную крышку с охлаждающей пластины.

Step 6

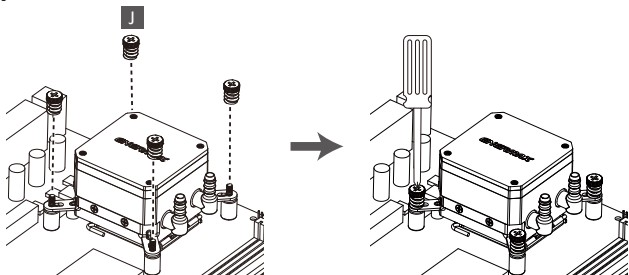

- EN** Place the pump on the CPU and tighten the spring screws until all four corners are secured.
- DE** Platzieren Sie die Pumpe auf der CPU und drehen Sie die Federschrauben fest bis alle vier Seiten fixiert sind.
- FR** Placez la pompe sur le CPU et serrez les vis à ressort jusqu'à ce que les quatre coins soient bien fixés.
- IT** Posizionare la pompa sulla CPU e fissare le viti fino a che tutti e quattro gli angoli siano fissati.
- ES** Coloque la bomba en la CPU y apriete los tornillos hasta que las cuatro esquinas estén fijadas.
- PL** Umieść pompę na procesorze i przykręć wszystkie cztery śrubki sprężyste.
- TW** 將水泵至於CPU上並鎖緊四邊彈簧螺絲
- CN** 將水泵置于CPU上并确认四边的弹簧螺丝拧紧
- JP** 専用ネジを使用して水冷ポンプをCPUの上に固定して下さい。
- KR** CPU 에 펌프를 놓고 펌프의 네 코너가 단단히 고정 될 때까지 스프링 나사를 고정 하십시오.
- ID** Tempatkan pompa pada CPU dan kencangkan keempat sekrup sampai keempat sudut aman.
- RU** Установите насос на процессоре и затяните все 4 гайки.

Intel Installation

Step 7

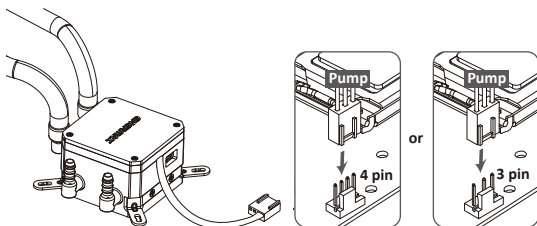

- EN** Connect the pump power connector to the motherboard.
Notice: If you recognize that your mainboard's CPU fan or PWM sockets do not provide enough voltage to power the pump, please use the included 4-pin Molex adaptor and connect the pump directly to your PSU.
- DE** Schließen Sie den Stromstecker der Pumpe am Mainboard an.
Hinweis: Wenn Sie bemerken, dass die CPU-Fan- und PWM-Sockel Ihres Mainboards für den Betrieb der Pumpe eine zu geringe Spannung erreichen, schließen Sie diese bitte über den mitgelieferten 4-Pin-Molex-Adapter direkt an das Netzteil an.
- FR** Branchez le connecteur d'alimentation de la pompe à la carte-mère.
Remarque : Si vous constatez que le connecteur du ventilateur CPU ou le PWM de la carte mère ne fournissent pas suffisamment de courant à la pompe, nous vous recommandons d'utiliser le câble adaptateur 4 broches Molex inclus que vous connecterez à l'alimentation.
- IT** Collegare il connettore di alimentazione della pompa alla scheda madre.
Avviso: se notate che il socket PWM o il socket per la ventola della CPU non forniscono un tensione sufficiente per alimentare la pompa, si prega di utilizzare l'adattatore Molex a 4 pin in dotazione e collegare la pompa direttamente alla PSU.
- ES** Conecte el cable de la bomba a la placa madre.
Aviso: Si se nota que el enchufe PWM o el enchufe para el ventilador de la CPU no proporcionan suficiente voltaje para alimentar la bomba, se ruega utilizar el adaptador Molex de 4 patillas incluido y conectar la bomba directamente a la fuente de alimentación.
- PL** Podłącz wtyczkę do zasilania pompy do płyty głównej.
Uwaga: Jeśli gniazda płyty głównej „CPU Fan” oraz PWM nie zapewniają wystarczającego napięcia do zasilania pompy, proszę podłączyć pompę bezpośrednio do zasilacza za pomocą 4-pinowego adaptera Molex.
- TW** 連接水泵電源於主板
注意：為確保水泵維持長時間全速運轉，若您主機板上的CPU風扇或PWM插座未能提供足夠電壓驅動水泵時，建議您使用內附4pin轉接線連接至電源供應器，以達到產品最佳效能。
- CN** 请将水泵电源与主板相应供电口连接
注意：为确保水泵能长时间全速运转，若您主板上的CPU风扇或者PWM接口不能提供足够电压带动水泵，建议使用内附4pin转接线连接至电源，以达到产品最佳效能。
- JP** 水冷ポンプのコネクターをマザーボードに接続して下さい。
注意：ご使用のマザーボードのCPUファンコネクターまたはPWMファンコネクターがポンプに十分な電圧を供給しない場合は、付属の4-pin Molex変換アダプターをご使用いただき、電源ユニットに直接ポンプを接続してください。
- KR** 펌프 전원 커넥터를 마더보드에 연결하십시오.
주의사항 : 메인보드 CPU Fan 또는 PWM 소켓에 연결 했을 시 충분한 전압을 펌프로 제공을 하지 못하면, 별도로 제공한 4핀 Molex 케이블을 이용하여 파워서플라이에 직접연결 하십시오.
- ID** Hubungkan konektor daya pompa ke motherboard.
Catatan : jika anda menyadari socket power cpu fan atau pwm motherboard anda, tidak bisa memberikan daya yang cukup untuk pompa watercooling, silahkan menggunakan 4pin molex adaptor dan sambungkan langsung ke power PSU.
- RU** Пожалуйста, подключите разъем питания насоса к материнской плате.
Примечание: Если Вы заметили, что разъем материнской платы выдаёт низкое напряжение для работы насоса, пожалуйста, подключите насос с помощью прилагаемого 4-контактного Molex адаптера непосредственно к блоку питания.

Step 8

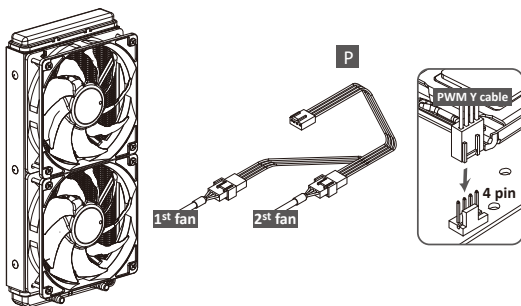

- EN** Connect the fan connector to the motherboard.
- DE** Schließen Sie den 4-Pin-PWM-Stecker des Lüfters am Mainboard an.
- FR** Branchez le connecteur du ventilateur à la carte-mère.
- IT** Collegare il connettore della ventola alla scheda madre.
- ES** Conecte el conector del ventilador a la placa madre.
- PL** Podłącz wtyczkę 4-pin PWM wentylatora do płyty głównej.
- TW** 連接風扇電源於主板
- CN** 请将风扇电源与主板上的相应供电口连接
- JP** ファンコネクターをマザーボードに接続して下さい。
- KR** 팬 커넥터를 마더보드에 연결하십시오.
- ID** Hubungkan konektor kipas ke motherboard.
- RU** Пожалуйста, подключите разъем вентилятора к материнской плате.

AMD Installation

AMD Installation

Step 1

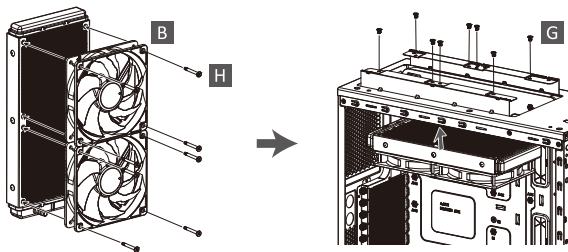

- EN** Attach the fan and the radiator to the chassis.
- DE** Schrauben Sie den Lüfter und den Radiator am Gehäuse fest.
- FR** Fixez le ventilateur et le radiateur sur le châssis.
- IT** Fissare la ventola e il radiatore al case.
- ES** Fijar el ventilador y el radiador a la caja.
- PL** Zamontuj wentylator i radiator na obudowie komputerowej.
- TW** 安裝風扇及散熱排於機殼
- CN** 将风扇以及散热排安装在机箱上
- JP** ファンをラジエーターに設置してケースに取り付けて下さい。
- KR** 팬과 방열기를 PC 케이스에 부착하십시오.
- ID** Pasang kipas dan radiator ke casing.
- RU** Закрепите вентилятор и радиатор на корпусе.

AMD Installation

Step 2

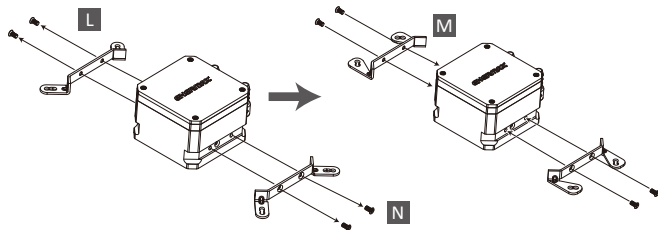

- EN** Remove the preinstalled Intel clip and install the AMD clip to the pump.
- DE** Entfernen Sie die vorinstallierten Halterungen für Intel-Plattformen und montieren Sie die AMD-Halterungen an der Pumpe.
- FR** Enlevez les clips Intel pré-installés et fixez les clips AMD à la pompe.
- IT** Rimuovere il clip Intel preinstallato e installare il clip AMD alla pompa.
- ES** Quitar el clip Intel preinstalado e instalar el clip AMD a la bomba.
- PL** Zdjąć przeznaczone do procesorów Intel wsporniki mocujące i zamontuj wsporniki mocujące do procesorów AMD.
- TW** 移除預裝Intel扣具後安裝AMD支架於泵浦
- CN** 移除预装Intel扣具后安装AMD支架于泵浦
- JP** 元々取り付けられていたアダプタを外し、AMD用アダプタを取り付けてください。
- KR** 이미 설치된 Intel용 클립을 제거하고 AMD 용 클립을 펌프에 설치하십시오
- ID** Lepaskan clip intel yang sudah terpasang pada pompa dan gunakan clip amd pada pompa.
- RU** Удалите предустановленное крепление «Intel» и установите «AMD» крепление к насосу.

AMD Installation

Step 3

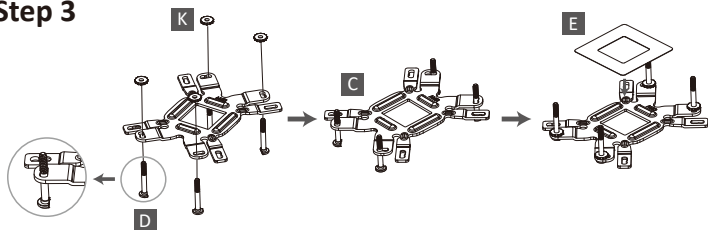

- EN** Insert the position screw into the appropriate hole on the back plate for your CPU socket. Place the square spacer on the central hole of the back plate.
- DE** Drehen Sie die Montageschrauben in die zu Ihrem Sockel passende Bohrung in der Backplate. Legen Sie den Unterlegrahmen über die Backplate-Öffnung.
- FR** Insérez la vis de fixation à l'emplacement prévu sur la plaque arrière de votre CPU. Veuillez placer l'entretoise carré sur le trou central situé sur la plaque arrière.
- IT** Inserire le viti di montaggio nel foro appropriato nella piastra posteriore per il socket della vostra CPU. Sistemare il distanziatore sul foro centrale della piastra posteriore.
- ES** Inserte los tornillos de montaje en el agujero correspondiente en la placa trasera del socket de la CPU. Coloque el espaciador en el agujero central de la placa posterior.
- PL** W zależności od platformy procesora wkręć śruby dystansowe w odpowiednie otwory na płycie mocującej (Backplate). Umieść podkładkę nad otwór w płycie mocującej (Backplate).
- TW** 依系統CPU腳位將定位螺絲固定於背板相對應孔位，將方形墊片置於背板中央孔位。
- CN** 根据系统CPU针脚将定位螺丝固定在背板相应孔位，将方形吊盘置于背板中央孔位。
- JP** CPUソケットに合ったバックプレートと専用ネジをお使いください。四角スペーサーをバックプレートの中心に取り付けて下さい。
- KR** CPU 소켓 설치를 위해 백 플레이트를 적절한 홀에 위치 후 나사를 이용해 고정해 주십시오. 스퀘어 스페이스를 백 플레이트의 중앙에 위치시키십시오.
- ID** Posisikan sekrup pada lubang yang sesuai di back plate untuk socket CPU anda. Tempatkan spacer persegi pada tengah lubang di back plate.
- RU** Установите винты для крепёжной пластины в соответствующие отверстия для вашего процессора. Пожалуйста, положите квадратную прокладку на центральное отверстие крепёжной пластины.

AMD Installation

Step 4

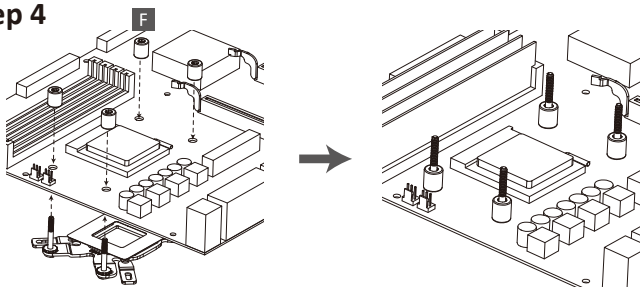

EN Install the AMD back plate on to the back of motherboard; fix the back plate with the stand-off.

DE Befestigen Sie die AMD-Backplate auf der Mainboard-Rückseite. Schrauben Sie die Backplate mit den zugehörigen Abstandshaltern fest.

FR Installez la plaque arrière AMD sous la carte-mère à l'aide des vis du support.

IT Installare la piastra posteriore AMD nella parte posteriore della scheda madre; fissare la piastra posteriore con il montante.

ES Instalar la placa posterior AMD en la parte posterior de la placa madre, fijar la placa posterior con el tornillo de pilar.

PL Umieścić płytę mocującą pod płytą główną i wkręcić za pomocą nakrętek mocujących.

TW 將AMD強化背板以套筒固定於主板背面

CN 將AMD強化背板以套筒固定于主板背面

JP AMD用バックプレートをマザーボードの裏側に配置し、専用ネジで固定して下さい。

KR AMD 백 플레이트를 마더보드 후면에 설치하십시오. 백 플레이트를 지지대로 고정합니다.

ID Pasang back plate AMD pada bagian belakang motherboard, kencangkan back plate dengan stand off.

RU Установите крепёжную пластину «AMD» на материнской плате, затем закрепите крепёжную пластину с помощью винтов.

AMD Installation

Step 5

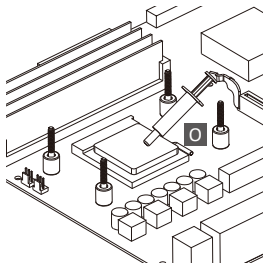

- EN** Apply the thermal grease evenly on the CPU surface.
- DE** Verteilen Sie gleichmäßig eine dünne Schicht Wärmeleitpaste auf der CPU-Oberfläche.
- FR** Appliquez une couche uniforme de pâte thermique sur la surface du CPU.
- IT** Applicare in modo uniforme la pasta termica sulla superficie della CPU.
- ES** Aplicar de forma uniforme la pasta térmica en la superficie de la CPU.
- PL** Nałożyć równomiernie cienką warstwę pasty termoprzewodzącej na metalową osłonę na procesorze.
- TW** 將散熱膏均勻的塗抹於CPU表面
- CN** 请在CPU表面均匀涂抹散热硅脂
- JP** サーマルグリスをCPUの表面に均一になるよう薄く塗って下さい。
- KR** CPU 표면에 그리스를 평평히 펴 바르십시오.
- ID** Oleskan secara merata thermal pasta ke permukaan CPU.
- RU** Нанесите термопасту равномерно на поверхность процессора.

AMD Installation

Step 6

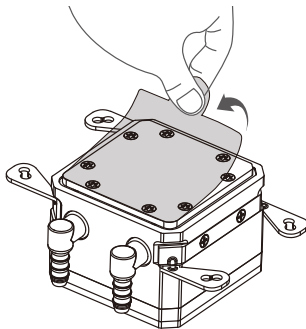

- EN** Remove the protect film from the cold-plate.
- DE** Entfernen Sie die Schutzfolie von der Kühlplatte der Pumpe.
- FR** Retirez le film protecteur de la plaque-froide.
- IT** Rimuovere la pellicola di protezione dalla piastra di raffreddamento.
- ES** Quite la película de protección del bloque de refrigeración.
- PL** Zdjąć folię ochronną z bloku wodnego.
- TW** 取下水冷頭保護貼膜
- CN** 使用时请将水冷头保护贴膜取下
- JP** コールドプレートの保護フィルムを外して下さい。
- KR** 쿨드 플레이트의 보호 필름을 제거하십시오.
- ID** Lepaskan pita pelindung dari plat pendingin.
- RU** Пожалуйста, удалите защитную крышку с охлаждающей пластины.

AMD Installation

Step 7

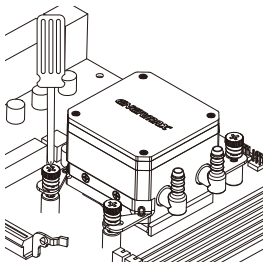
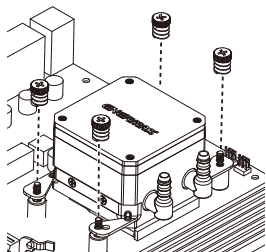

- EN** Place the pump on the CPU and tighten the spring screws until all four corners are secured.
- DE** Platzieren Sie die Pumpe auf der CPU und drehen Sie die Federschrauben fest bis alle vier Seiten fixiert sind.
- FR** Placez la pompe sur le CPU et serrez les vis à ressort jusqu'à ce que les quatre coins soient bien fixés.
- IT** Posizionare la pompa sulla CPU e fissare le viti fino a che tutti e quattro gli angoli siano fissati.
- ES** Coloque la bomba en la CPU y apriete los tornillos hasta que las cuatro esquinas estén fijadas.
- PL** Umieść pompę na procesorze i przykręć wszystkie cztery śrubki sprężyste.
- TW** 將水泵至於CPU上並鎖緊四邊彈簧螺絲
- CN** 將水泵置于CPU上并确认四边的弹簧螺丝拧紧
- JP** 専用ネジを使用して水冷ポンプをCPUの上に固定して下さい。
- KR** CPU 에 펌프를 놓고 펌프의 네 코너가 단단히 고정 될 때까지 스프링 나사를 고정하십시오.
- ID** Tempatkan pompa pada CPU dan kencangkan keempat sekrup sampai keempat sudut aman.
- RU** Установите насос на процессоре и затяните все 4 гайки.

AMD Installation

Step 8

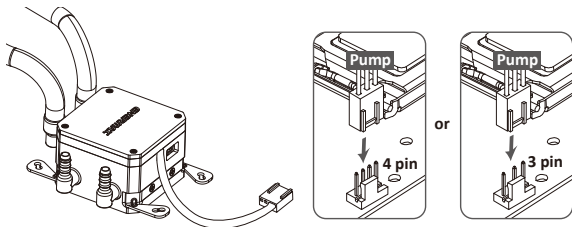

EN Connect the pump power connector to the motherboard.

Notice: If you recognize that your mainboard's CPU fan or PWM sockets do not provide enough voltage to power the pump, please use the included 4-pin Molex adaptor and connect the pump directly to your PSU.

DE Schließen Sie den Stromstecker der Pumpe am Mainboard an.

Hinweis: Wenn Sie bemerken, dass die CPU-Fan- und PWM-Socket Ihres Mainboards für den Betrieb der Pumpe eine zu geringe Spannung erreichen, schließen Sie diese bitte über den mitgelieferten 4-Pin-Molex-Adapter direkt an das Netzteil an.

FR Branchez le connecteur d'alimentation de la pompe à la carte-mère.

Remarque : Si vous constatez que le connecteur du ventilateur CPU ou le PWM de la carte mère ne fournissent pas suffisamment de courant à la pompe, nous vous recommandons d'utiliser le câble adaptateur 4 broches Molex inclus que vous connecterez à l'alimentation.

IT Collegare il connettore di alimentazione della pompa alla scheda madre.

Avviso: se notate che il socket PWM o il socket per la ventola della CPU non forniscono una tensione sufficiente per alimentare la pompa, si prega di utilizzare l'adattatore Molex a 4 pin in dotazione e collegare la pompa direttamente alla PSU.

ES Conecte el cable de la bomba a la placa madre.

Aviso: Si se nota que el enchufe PWM o el enchufe para el ventilador de la CPU no proporcionan suficiente voltaje para alimentar la bomba, se ruega utilizar el adaptador Molex de 4 patillas incluido y conectar la bomba directamente a la fuente de alimentación.

PL Podłącz wtyczkę do zasilania pompy do płyty głównej.

Uwaga: Jeśli gniazda płyty głównej „CPU Fan” oraz PWM nie zapewniają wystarczającego napięcia do zasilania pompy, proszę podłączyć pompę bezpośrednio do zasilacza za pomocą 4-pinowego adaptera Molex.

TW 連接水泵電源於主板

注意：為確保水泵維持長時間全速運轉，若您主機板上的CPU風扇或PWM插座未能提供足夠電壓驅動水泵時，建議您使用內附4pin轉接線連接至電源供應器，以達到產品最佳效能。

CN 请将水泵电源与主板相应供电口连接

注意：为确保水泵能长时间全速运转，若您主板上的CPU风扇或者PWM接口不能提供足够电压带动水泵，建议使用内附4pin转接线连接至电源，以达到产品最佳效能。

JP 水冷ポンプのコネクターをマザーボードに接続して下さい。

注意：ご使用のマザーボードのCPUファンコネクターまたはPWMファンコネクターがポンプに十分な電圧を供給しない場合は、付属の4-pin Molex変換アダプターをご使用いただき、電源ユニットに直接ポンプを接続してください。

KR 펌프 전원 커넥터를 마더보드에 연결하십시오.

주의사항 : 메인보드 CPU Fan 또는 PWM 소켓에 연결했을 시 충분한 전압을 펌프로 제공을 하지 못하면, 별도로 제공한 4pin Molex 케이블을 이용하여 파워서플라이에 직접연결 하십시오.

ID Hubungkan konektor daya pompa ke motherboard.

Catatan : jika anda menyadari socket power cpu fan atau pwm motherboard anda, tidak bisa memberikan daya yang cukup untuk pompa watercooling, silahkan menggunakan 4pin molex adaptor dan sambungkan langsung ke power PSU.

RU Пожалуйста, подключите разъем питания насоса к материнской плате.

Примечание: Если Вы заметили, что разъем материнской платы выдаёт низкое напряжение для работы насоса, пожалуйста, подключите насос с помощью прилагаемого 4-контактного Molex адаптера непосредственно к блоку питания.

AMD Installation

Step 9

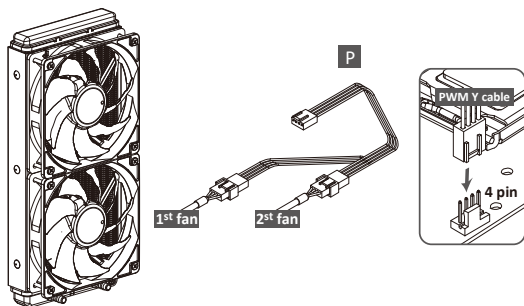

- EN** Connect the fan connector to the motherboard.
- DE** Schließen Sie den 4-Pin-PWM-Stecker des Lüfters am Mainboard an.
- FR** Branchez le connecteur du ventilateur à la carte-mère.
- IT** Collegare il connettore della ventola alla scheda madre.
- ES** Conecte el conector del ventilador a la placa madre.
- PL** Podłącz wtyczkę 4-pin PWM wentylatora do płyty głównej.
- TW** 連接風扇電源於主板
- CN** 请将风扇电源与主板上的相应供电口连接
- JP** ファンコネクタをマザーボードに接続して下さい。
- KR** 팬 커넥터를 마더보드에 연결하십시오.
- ID** Hubungkan konektor kipas ke motherboard.
- RU** Пожалуйста, подключите разъем вентилятора к материнской плате.

Motherboard Sync

Motherboard Sync

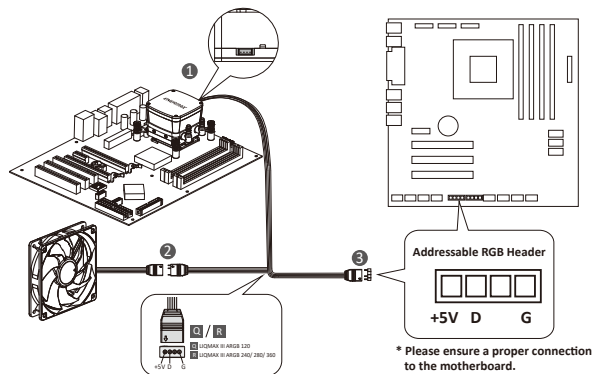

- EN** Connect the sync cable to a supported motherboard with ARGB header
- DE** Verbinden Sie das Sync-Kabel mit einem kompatiblen Motherboard mit ARGB-Header.
- FR** Si la carte mère prend en charge le connecteur RGB (ADD headers): connectez le câble de synchronisation RGB à la carte mère.
- IT** Se la scheda madre è fornita di connettori ARGB compatibili, collegare il cavo RGB Sync alla scheda madre.
- ES** Si su placa base está equipada con conectores ARGB compatibles, conecte el cable RGB Sync a la placa base
- PL** Jeśli płyta główna OBSŁUGUJE adresowalne nagłówki RGB (ADD): podłącz kabel synchronizacyjny RGB do płyty głównej.
- TW** 若您的主機板有支援addressable RGB (ADD headers)功能：將RGB同步線連接到主機板的RGB 4Pin接口。
- CN** 若您的主板有支援addressable RGB (ADD headers)功能：將RGB同步線連接到主板的RGB 4Pin接口。
- JP** マザーボードがアドレスサブル型ARGBに対応している場合、RGB SYNC用ケーブルをマザーボードに接続してください。
- KR** 마더보드가 RGB (ADD 헤더를) 지원하는 경우: RGB 동조 케이블을 마더보드에 연결하십시오.
- ID** Jika motherboard tidak mendukung header RGB (ADD) yang dapat dialamatkan : sambungkan kabel RGB Sync ke motherboard.
- RU** Если материнская плата поддерживает функцию ARGB, подключите кабель синхронизации RGB к материнской плате.

