

## BR-6473AX

# User Manual

12-2019 / v1.0

---

### **Edimax Technology Co., Ltd.**

No. 278, Xinhua 1st Rd., Neihu Dist., Taipei City, Taiwan

Email: [support@edimax.com.tw](mailto:support@edimax.com.tw)

---

### **Edimax Technology Europe B.V.**

Fijenhof 2, 5652 AE Eindhoven, The Netherlands

Email: [support@edimax.nl](mailto:support@edimax.nl)

---

### **Edimax Computer Company**

3444 De La Cruz Blvd., Santa Clara, CA 95054, USA

Email: [support@edimax.com](mailto:support@edimax.com)

# Contents

---

<b>I. Product Information</b> .....	<b>1</b>
<b>II. Package Contents</b> .....	<b>2</b>
II-1. System Requirements.....	2
II-2. Hardware Overview .....	3
II-3. LED Status.....	5
<b>III. Hardware Installation</b> .....	<b>6</b>
III-1. AP & Router Mode .....	8
<b>IV. Quick Setup</b> .....	<b>9</b>
<b>V. Wi-Fi Settings</b> .....	<b>16</b>
V-1. Main Wi-Fi .....	16
V-2. Guest Wi-Fi .....	18
V-3. WPS.....	19
<b>VI. Administration</b> .....	<b>21</b>
VI-1. System Information.....	22
VI-2. Password .....	23
VI-3. Firmware Upgrade .....	24
VI-4. Backup and Restore .....	25
VI-5. System Log.....	28
VI-6. Statistic.....	30
VI-7. Time Zone .....	31
<b>VII. Security</b> .....	<b>31</b>
VII-1. Access Control.....	32
VII-2. Port Forwarding.....	33
VII-3. DMZ.....	34

# I. Product Information

---

The Edimax BR-6473AX smart Wi-Fi router with Intel GRX350 (800MHz dual-core) and fast dual band speeds up to 574Mbps (2.4 GHz) and 2402Mbps (5 GHz) is well suited for your home.

The BR-6473AX with beamforming + 4X internal antennas delivers fast and reliable long range Wi-Fi coverage to every corner of your home.

With the simple and intuitive web UI interface, you can easily set up the router and remotely control through the browser or phone.

You can find all supporting documents from the link below or via QR Code:

<https://www.edimax.com/download>



(Once you've visited the Edimax official website, please enter the model no. "BR-6473AX" into the search box to search for your product.)

## Download

---

To select your product and find related download materials, enter the model number into the search box on the right side or follow the simple steps below:

\*Feel free to contact us anytime if you need help or if you can't find your product.

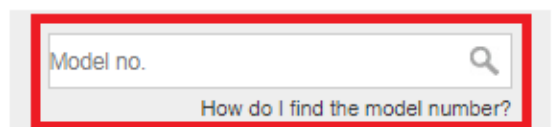
A screenshot of a search box on a website. The search box is rectangular with a light gray background and a red border. It contains the text "Model no." on the left and a magnifying glass icon on the right. Below the search box, there is a link that says "How do I find the model number?".

## **II. Package Contents**

---

Before start using this product, please check if there is anything missing in the package, and contact your dealer to claim the missing item(s):

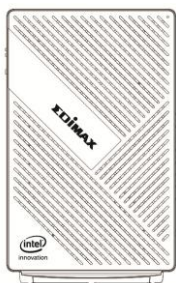

**BR-6473AX**



**Quick Installation Guide**

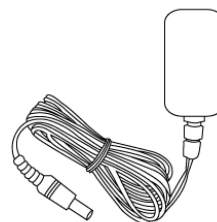

**Power Adapter (12V)**

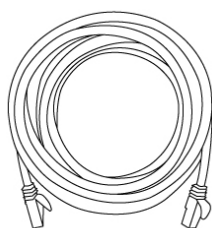

**Ethernet Cable**

### **II-1. System Requirements**

- Existing cable/DSL modem & router
- Computer with web browser for AP configuration

## II-2. Hardware Overview

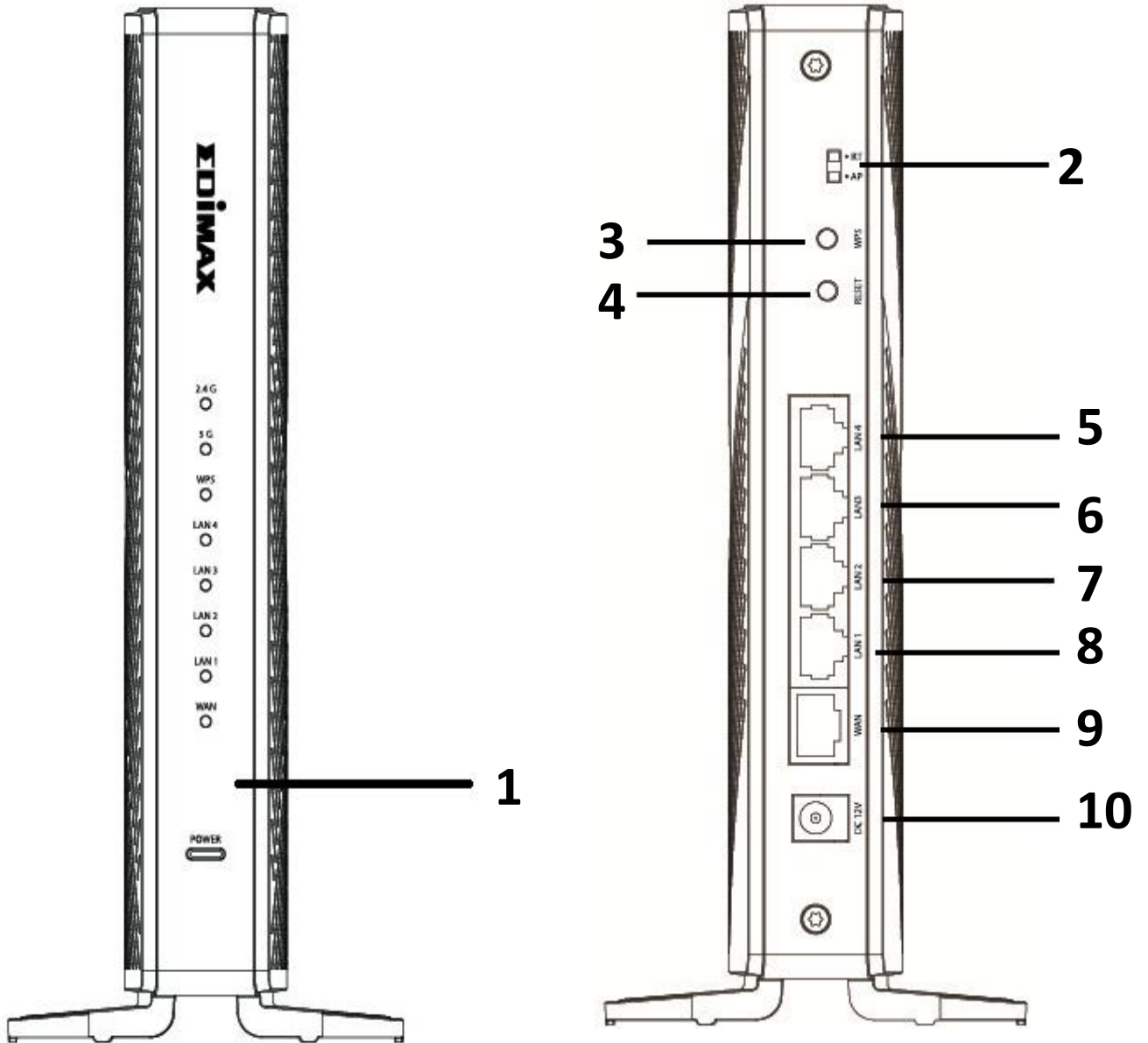

No.	Description
1	LED (2.4G, 5G, WPS, LAN1, LAN2, LAN3, LAN4, WAN, POWER)
2	Selector Switch (Router and AP mode)
3	WPS Button
4	RESET Button
5	LAN4 Port
6	LAN3 Port
7	LAN2 Port
8	LAN1 Port
9	WAN Port
10	DC Power Jack

### II-3. LED Status

Function	Color	Status	Description
2.4GHz & 5GHz	Blue	On	Internet connection is ready.
		Off	Wi-Fi not active.
		Flashing	Activity. Sending or receiving data.
WPS	BLUE	Blinking	WPS connection established. (WPS LED blinks for 2 seconds to indicate a successful connection)
LAN	Blue	On	LAN port is connected.
		Off	LAN port is not connected.
WAN	Blue	On	WAN port is connected.
		Off	WAN port is not connected, or no Internet.
Power	Red	Blinking	Upgrading firmware or reset.
	Green	on	Router mode. (Power on)
	Blue	on	AP mode. (Power on)

### ***III. Hardware Installation***

---

This section will guide you through the steps to set up the BR-6473AX.

1. Plug the included AC adapter into the router's power jack and the other end into an electrical socket.

**Note: Ensure the "POWER" LED lights on GREEN (Router Mode). If not, the device is not properly connected.**

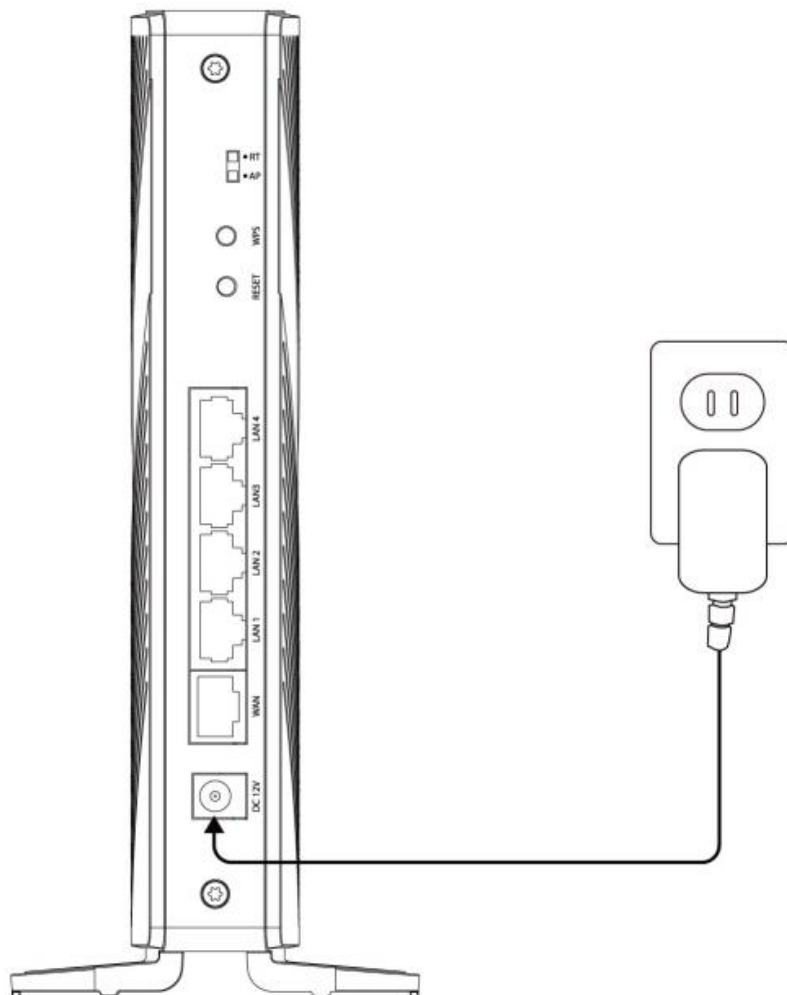



2. Connect an Ethernet cable to the "LAN" port on your XDSL/Cable modem. And connect your modem to the router of the "WAN" port with an Ethernet cable.

**NOTE: Ensure the "WAN" LED lights on BLUE.**

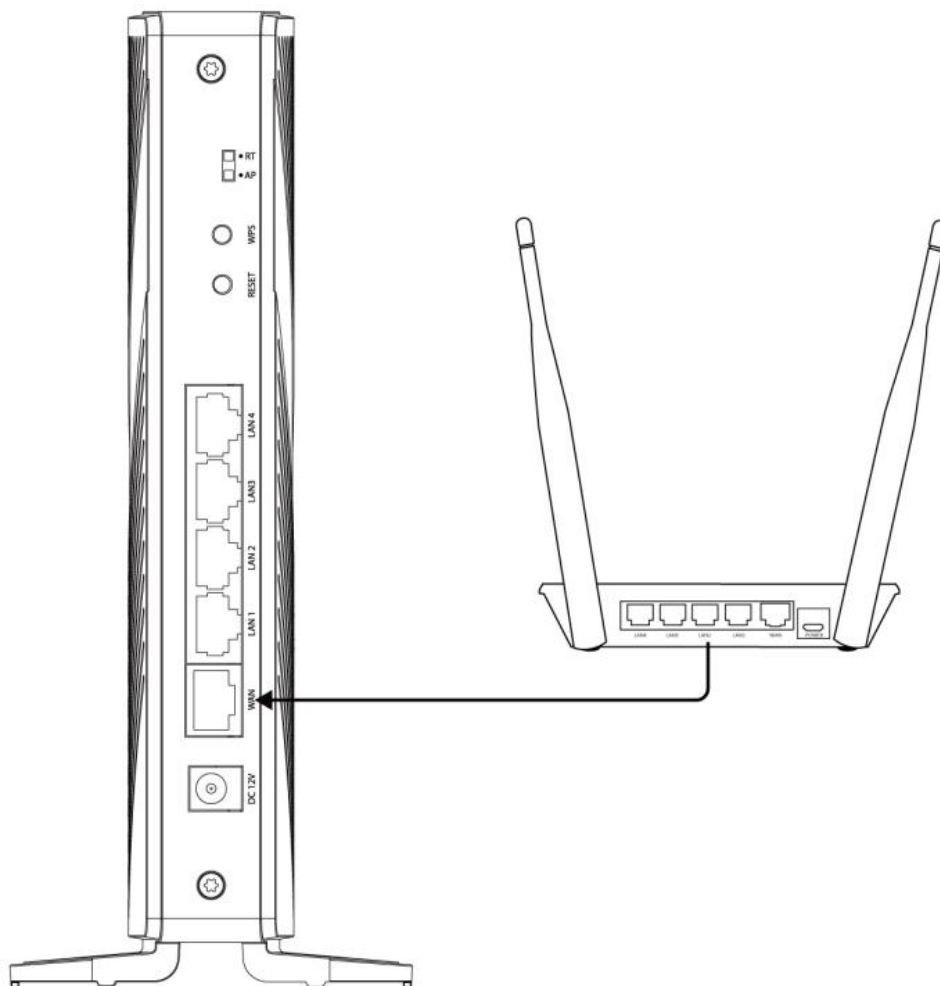

### III-1. AP & Router Mode

You can change the operation mode via the selector switch behind the router.

Move the selector switch left or right to change the operation mode (AP, router mode).

**NOTE: Please unplug the AC adapter when changing the operation mode.**

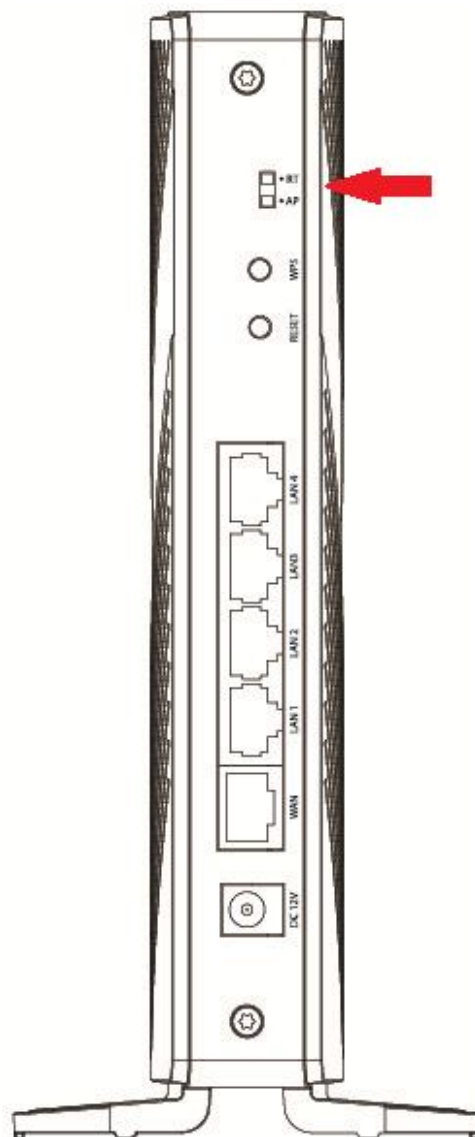

## IV. Quick Setup

---

This quick installation section will help you setup your router in its default router mode and configure its basic settings.

Please follow the steps below:

1. Please find the default User Name “admin” and unique 8 digits default Password “XXXXXXXX” of your router on the sticker.



**NOTE: If you are using iOS 11 or later version, you can easily connect your smart phone to the router using the QR code on the sticker.**

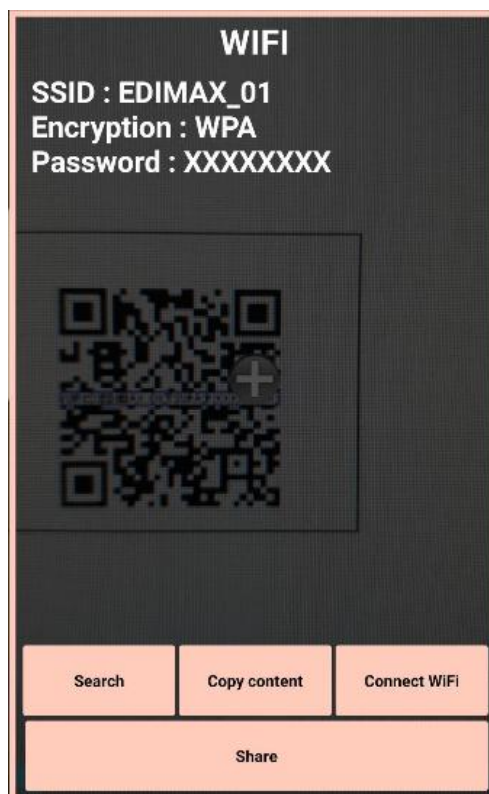

2. Open a web browser, and you will be prompted for a username and password. Enter the Username and the password. Click the “Sign in” button.



Sign in

http://192.168.2.1  
Your connection to this site is not private

Username

Password

3. Click the “Auto Detect” button to run the Easy Setup.

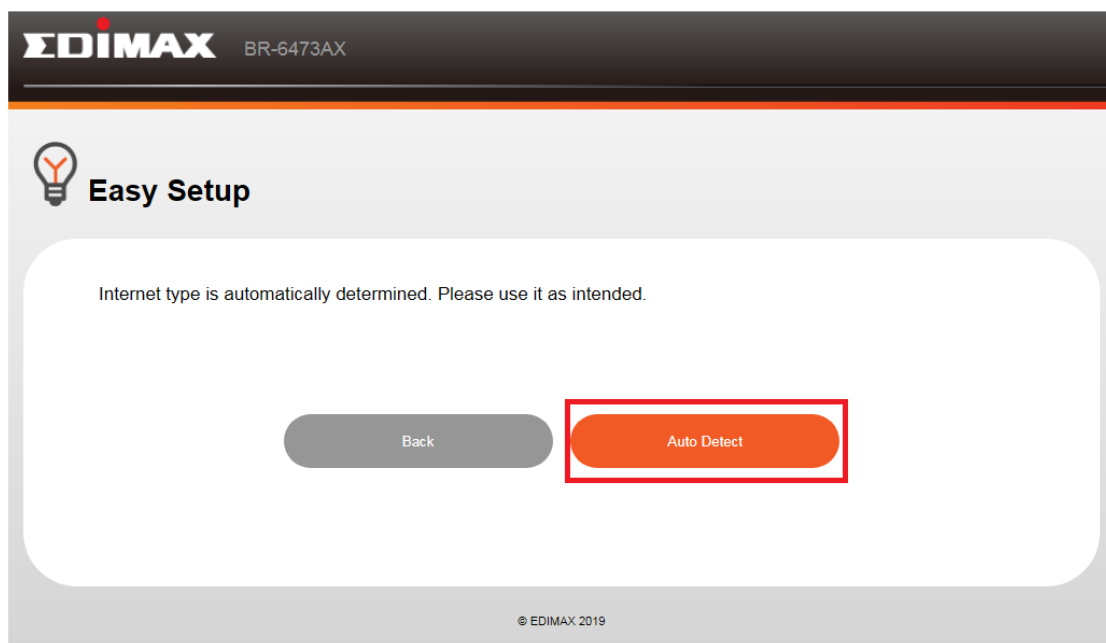

**EDIMAX** BR-6473AX

 **Easy Setup**

Internet type is automatically determined. Please use it as intended.

© EDIMAX 2019

**NOTE: In the Easy Setup, you can configure the router to access the Internet with different modes, such as DHCP, Static IP and PPPoE.**

## DHCP:

If you use DHCP, please wait while the router setting is completed.

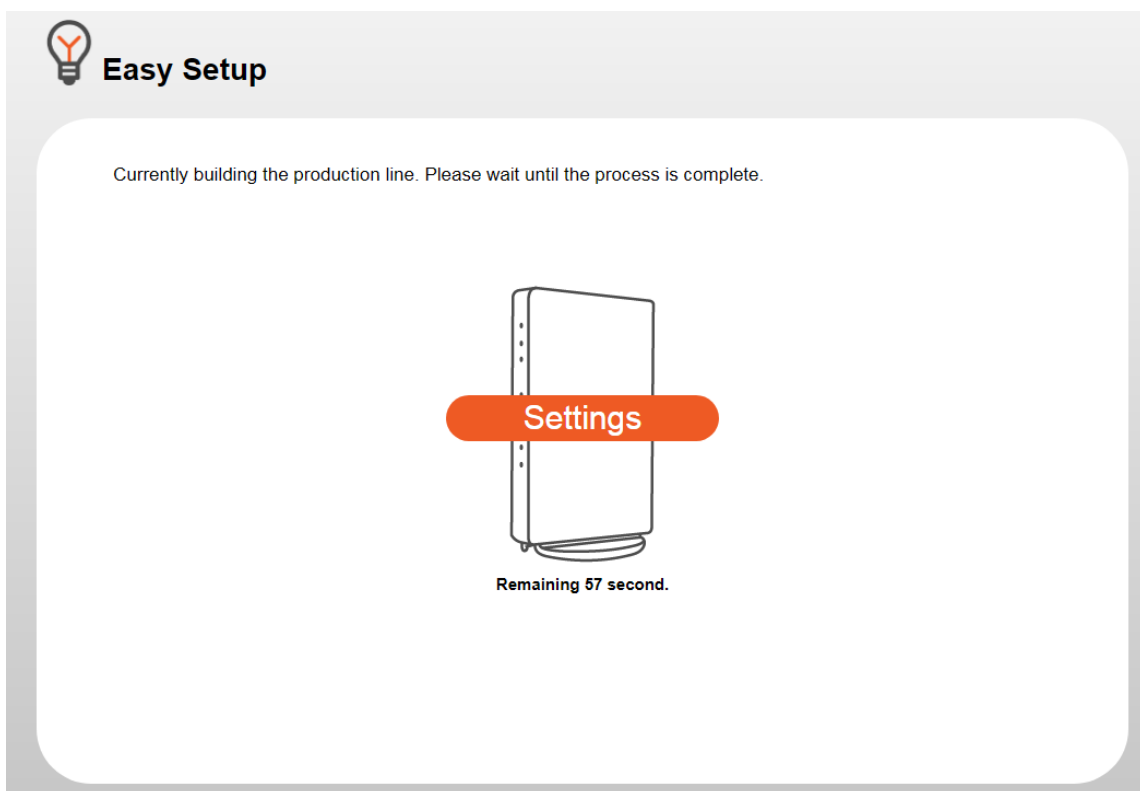
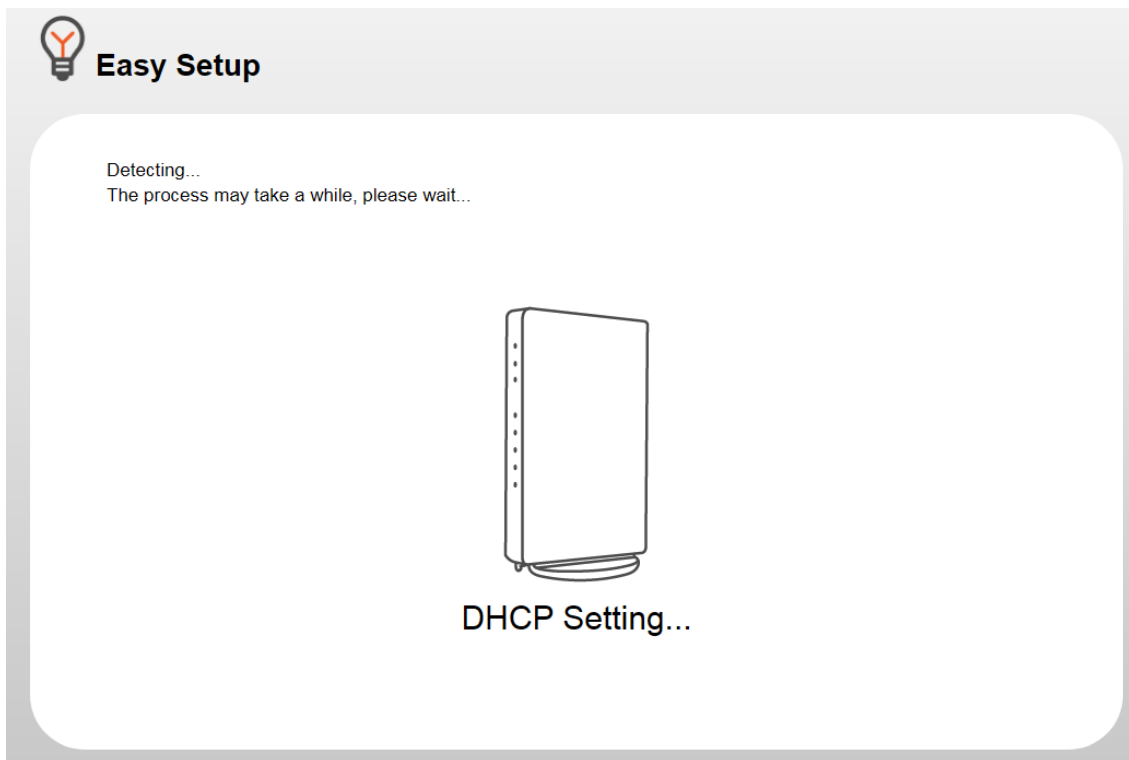

Click the “Setup Complete” button to complete the setup.

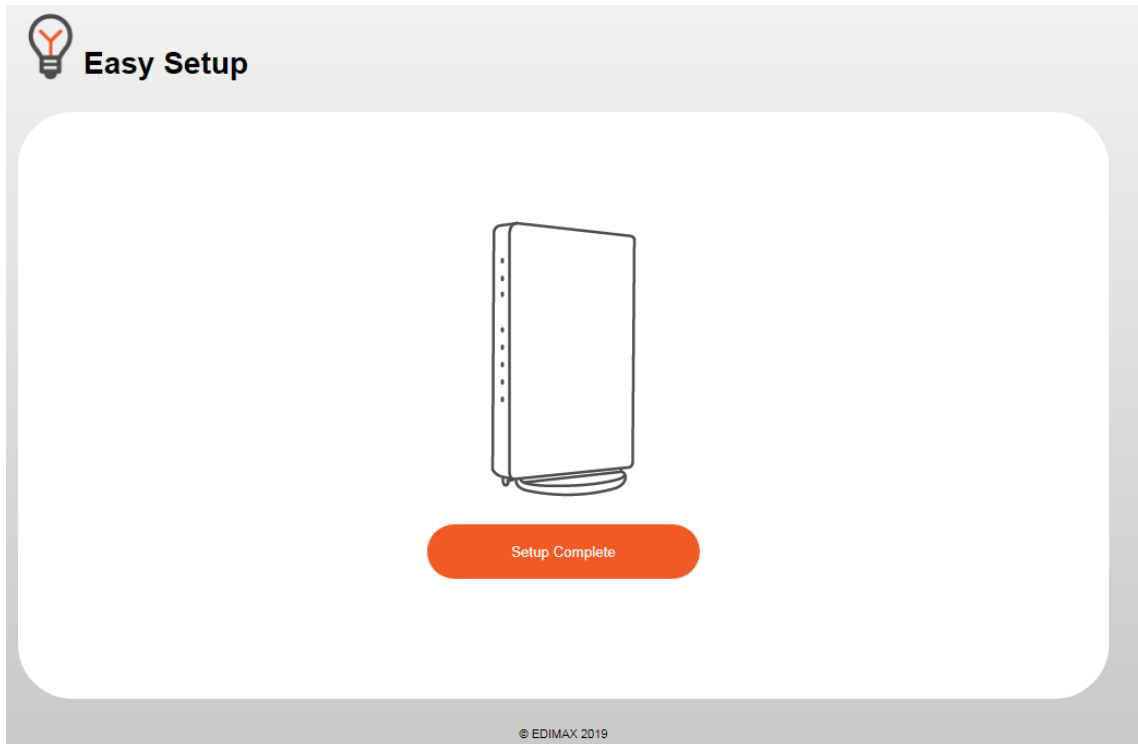

### Static IP:

Enter IP address, default gateway, subnet mask and DNS1/DNS2.

Click the “next” button to proceed to the next step.

The screenshot shows the "Easy Setup" interface for static IP configuration. It includes a lightbulb icon and the title "Easy Setup". Below the title is a block of instructional text: "Scheduled fixed IP delivery. Enter messages under each section and click 'next', If the selected static IP does not show on the display, please check the DHCP/PPPoE and then click on the 'back' button until the manual setting function appears, then choose the appropriate connection setting in the internet selection option under 'manual settings'".

Below the text are five input fields, each with a label to its left:

- IP Address
- Default Gateway
- Subnet Mask
- DNS1
- DNS2

At the bottom of the form are two buttons: a grey "Back" button and an orange "next" button.

<b>IP Address</b>	Displays the IP address of this router.
<b>Default Gateway</b>	Displays the IP address of the default gateway.
<b>Subnet Mask</b>	Specify a subnet mask. The default value is 255.255.255.0.
<b>DNS1</b>	For static IP users, the default value is blank.
<b>DNS2</b>	For static IP users, the default value is blank.

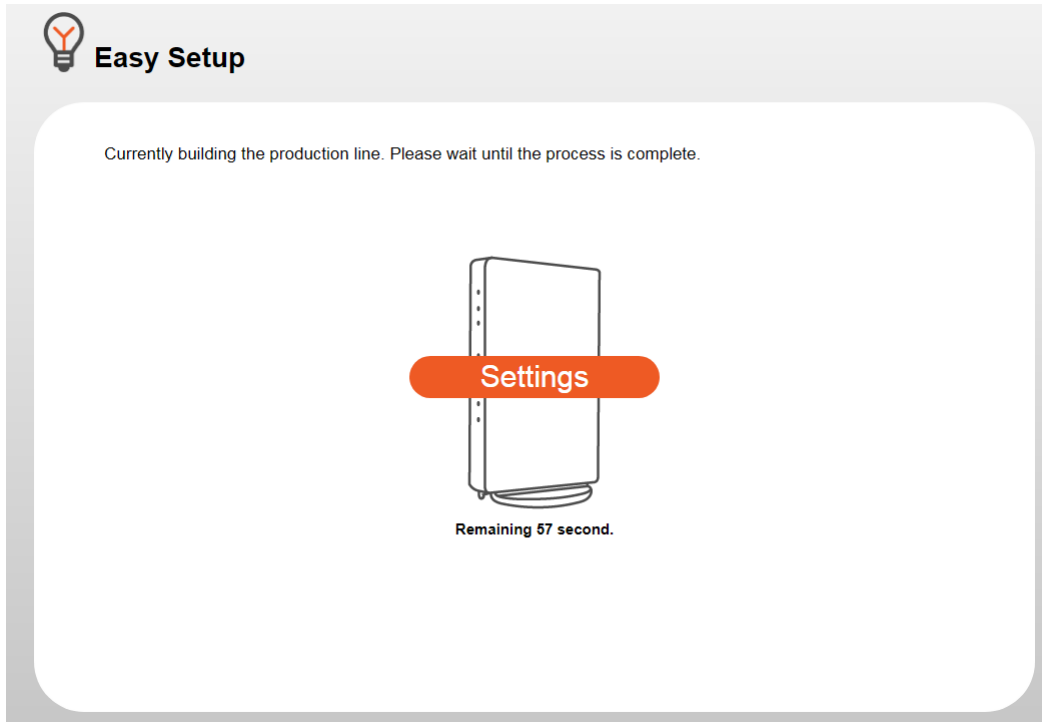

Click the “Setup Complete” button to complete the setup.

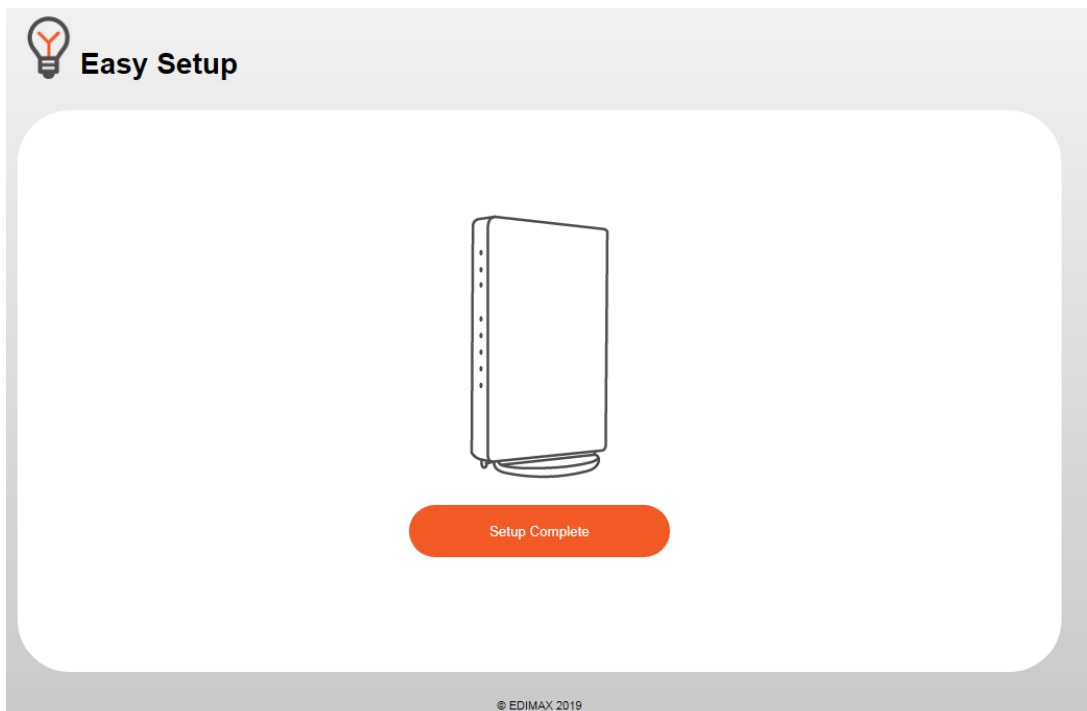

## PPPoE:

Enter the Username / Password and click the “next” button.

 **Easy Setup**

Type in the provided internet connection ID (username) and user identity password (password). Click next.  
Username must input after the "@" sign.

※ You can use the following characters in the user name and password.  
"Characters halfwidth font a~z, A~Z, 0~9, space, ., \_ @, \$, :, ;, \*, #, %, /, -, +, !, ="  
※ Max Characters is set to within 57 characters or symbols.

Username

Password

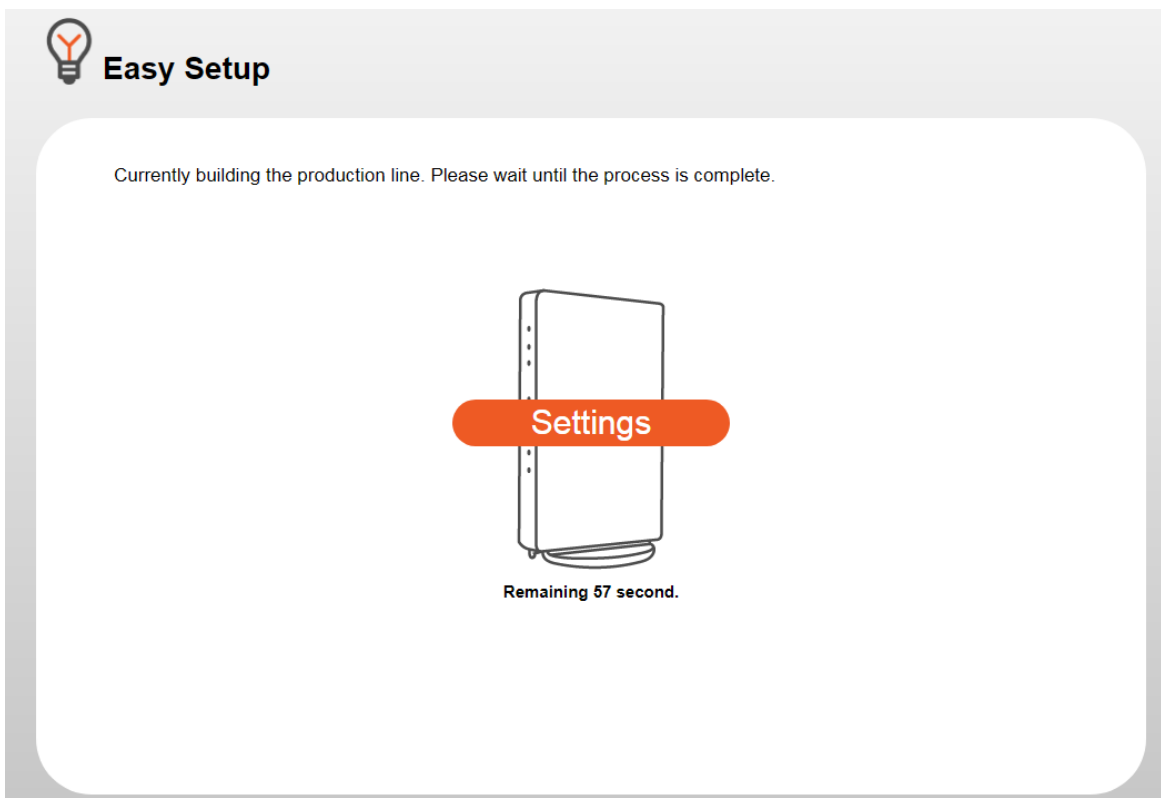



Click the “Setup Complete” button to complete the setup.

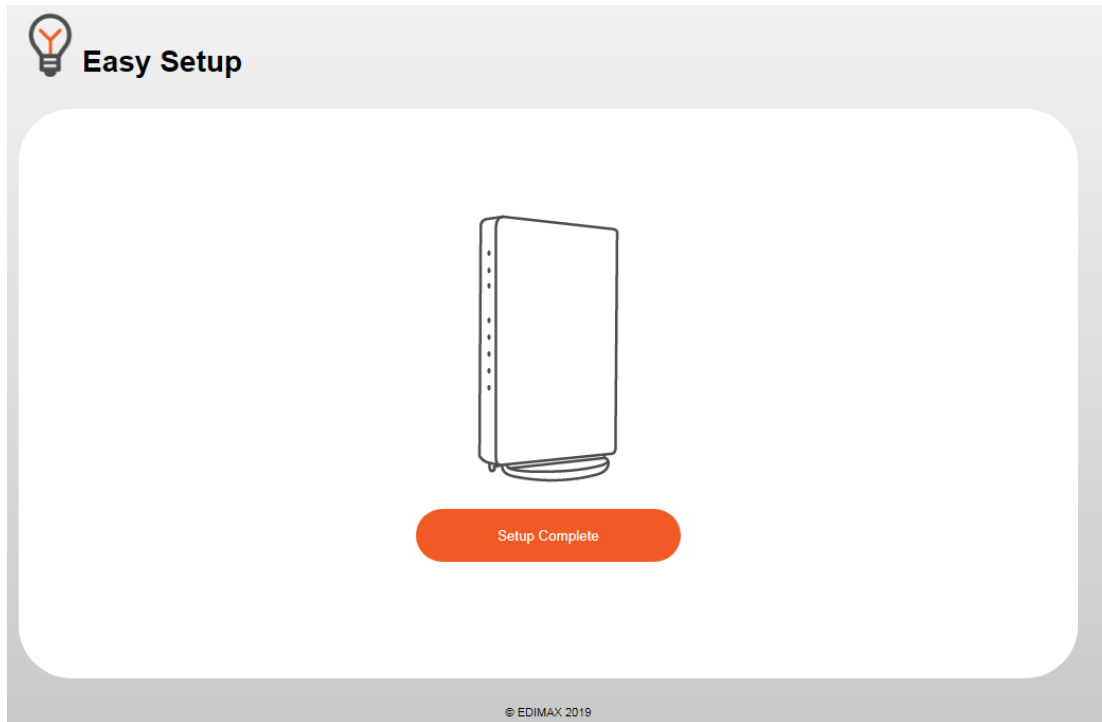

If settings failed or Ethernet cable is not connected properly, you will be prompted to check the following settings below,

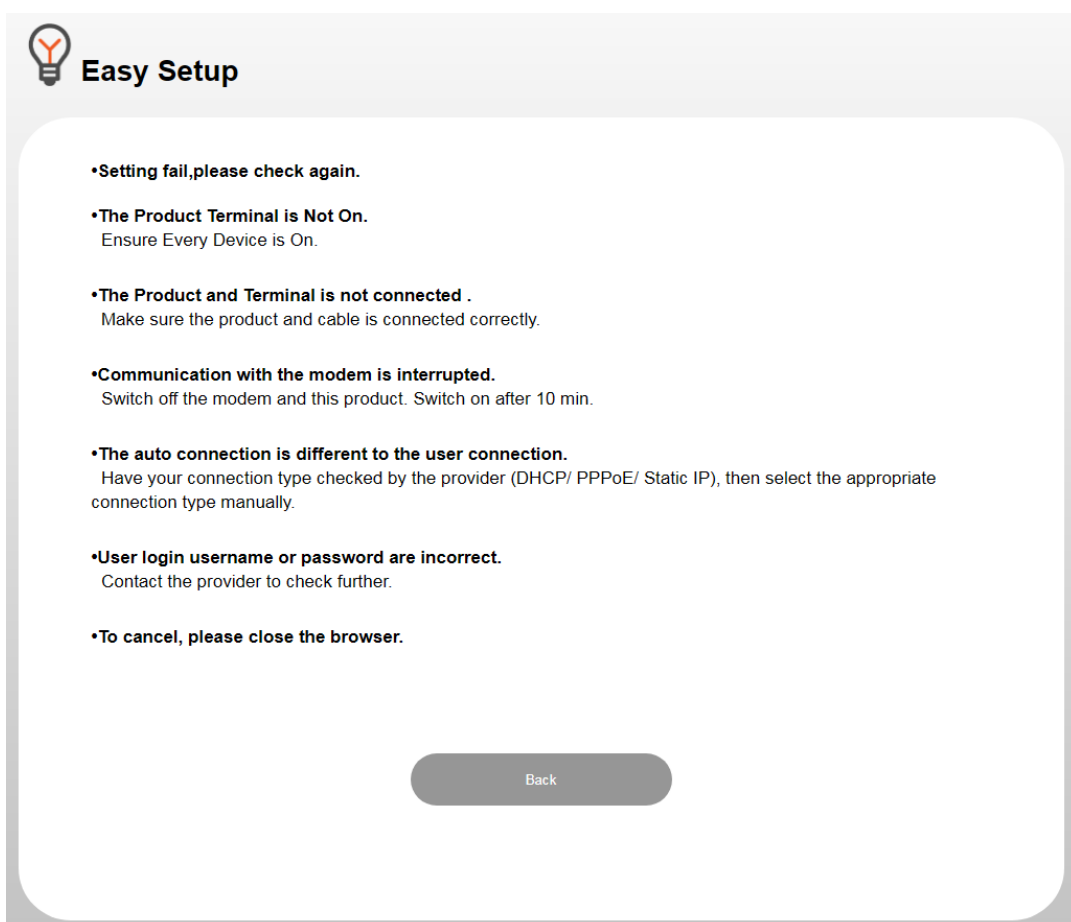

## V. Wi-Fi Settings

In this page allows you to configure the Wi-Fi, guest Wi-Fi and WPS settings that suit your needs.

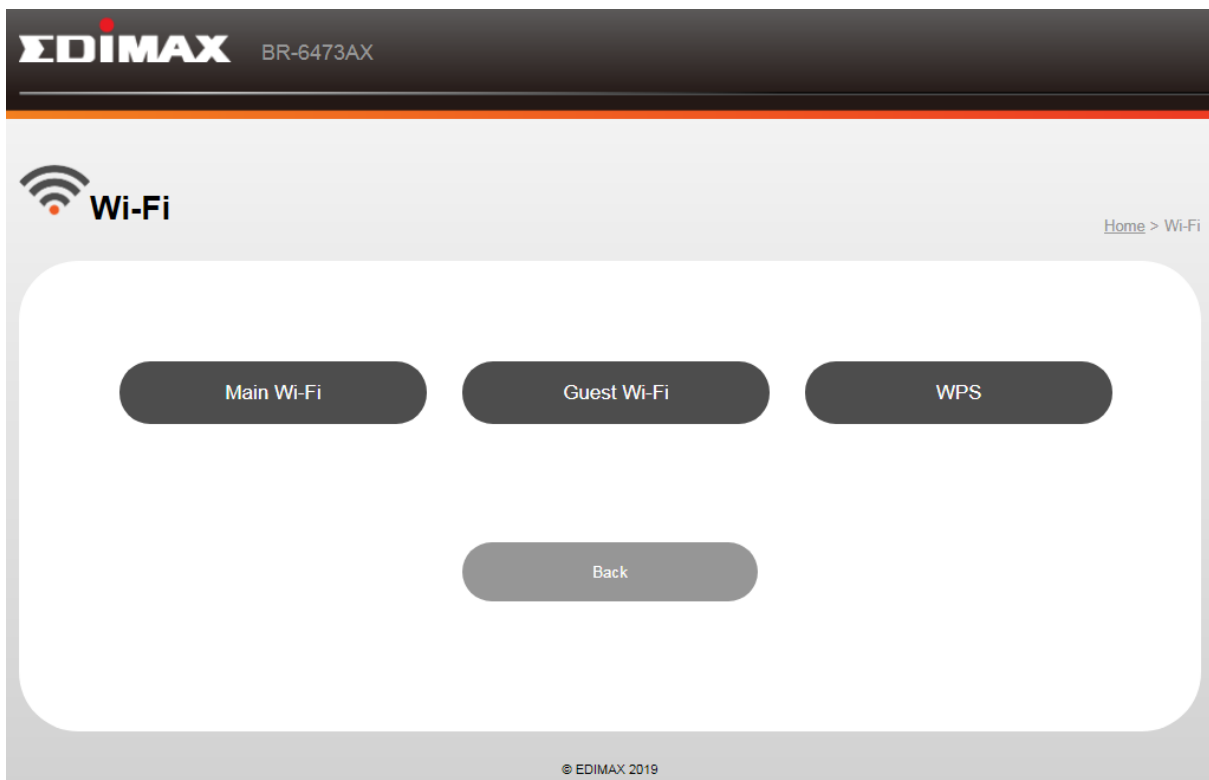

### V-1. Main Wi-Fi

You can change the basic settings for 2.4GHz and 5GHz.

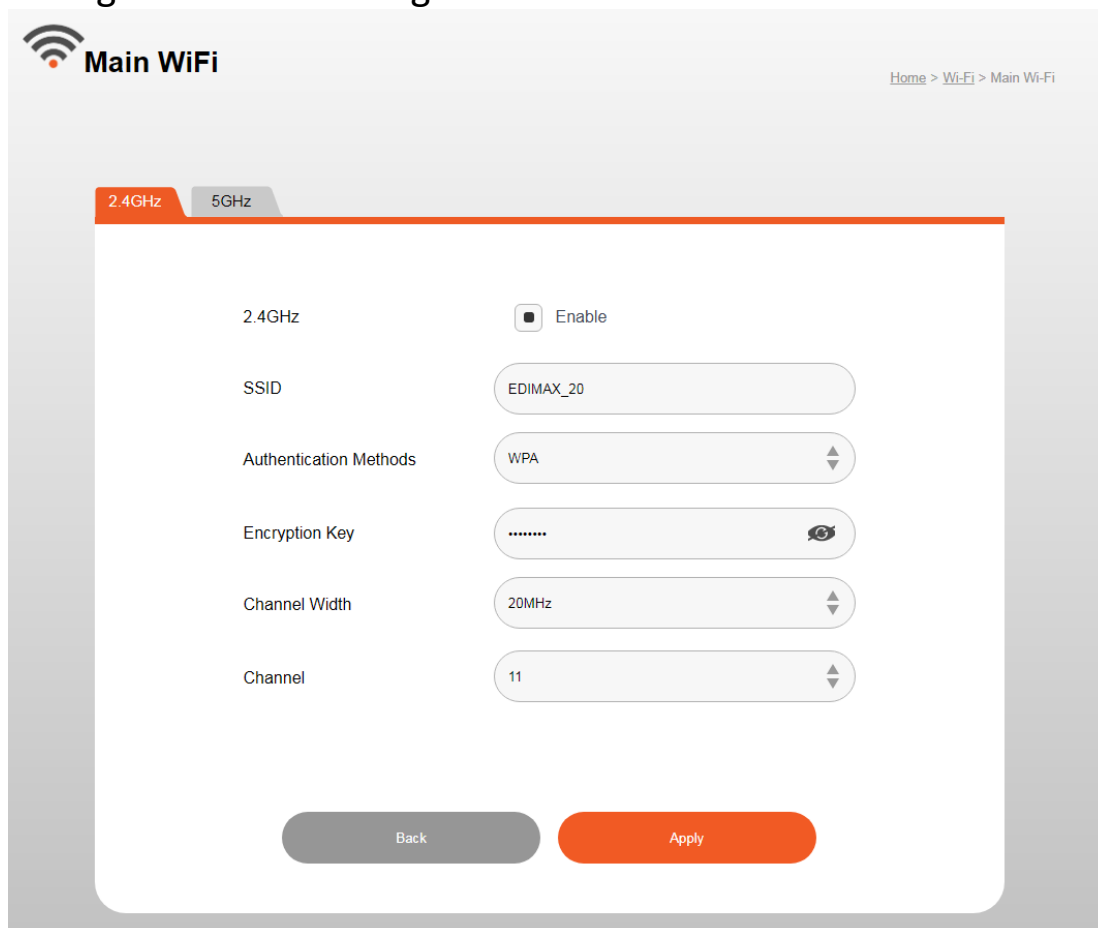

<b>Wireless 2.4GHz (5GHz) / SSID</b>	
<b>2.4GHz/ 5GHz</b>	Enable/ Disable
<b>SSID</b>	Displays the SSID name(s) for the specified frequency.
<b>Authentication Methods</b>	Displays the authentication method for the specified SSID.
<b>Encryption Key</b>	Displays the encryption type for the specified SSID.
<b>Channel</b>	<p>Set the channel width:</p> <p>2.4 GHz</p> <ul style="list-style-type: none"> <li>-20MHz (lower performance but less interference).</li> <li>-40MHz (higher performance but potentially higher interference)</li> <li>-Auto (automatically select based on interference level).</li> </ul> <p>5GHz</p> <ul style="list-style-type: none"> <li>-20MHz (lower performance but less interference).</li> <li>-40MHz</li> <li>-80MHz</li> <li>-160MHz (higher performance but potentially higher interference)</li> <li>-Auto (automatically select based on interference level).</li> </ul>
<b>Channel</b>	<p>2.4 GHz:</p> <p>Select a wireless channel from 1 – 11 or auto.</p> <p>5GHz:</p> <p>Select a wireless channel from 36 – 140 or auto.</p>

## V-2. Guest Wi-Fi

You can setup an additional “Guest” Wi-Fi network so guest users can enjoy Wi-Fi connectivity without accessing your primary networks.

The screenshot displays the 'Guest Wi-Fi' configuration page. At the top left is a Wi-Fi icon and the title 'Guest Wi-Fi'. At the top right is a breadcrumb trail: 'Home > Wi-Fi > Guest Wi-Fi'. The main content area contains four settings:

- Guest Wi-Fi:** A toggle switch labeled 'Enable' which is currently turned off.
- SSID:** A text input field containing 'GUEST\_20'.
- Authentication Methods:** A dropdown menu showing 'WPA'.
- Encryption Key:** A text input field with masked characters (dots) and an eye icon to toggle visibility.

At the bottom of the form are two buttons: a grey 'Back' button and an orange 'Apply' button.

<b>Guest Wi-Fi</b>	
<b>Guest Wi-Fi</b>	Enable/ Disable
<b>SSID</b>	Displays the SSID name(s) for the guest Wi-Fi.
<b>Authentication Methods</b>	Displays the authentication method for the specified SSID.
<b>Encryption Key</b>	Displays the encryption type for the guest Wi-Fi.

## V-3. WPS

WPS is a simple way to establish connections between WPS compatible devices. WPS can be activated on compatible devices by pushing a WPS button on the compatible device or from within the compatible device's firmware / configuration interface (known as PBC or "Push Button Configuration").

When WPS is activated in the correct manner and at the correct time for two compatible devices, they will automatically connect.

"PIN code WPS" is a variation of PBC which includes the additional use of a PIN code between the two devices for verification.

The screenshot shows a web interface for WPS configuration. At the top left is a Wi-Fi icon and the text 'WPS'. At the top right is a breadcrumb trail: 'Home > Wi-Fi > WPS'. The main content area has a white background with rounded corners. It contains the following elements: a 'WPS' label followed by a checked checkbox and the word 'Enable'; a 'Self Pin Code' label followed by the value '12345670'; a 'Configure via Push Button' label followed by an orange 'Start PBC' button; a 'Configure via Client Pin Code' label followed by a light gray input field and an orange 'Apply' button. At the bottom of the main area are two buttons: a gray 'Back' button and an orange 'Apply' button.

WPS	
<b>WPS</b>	Check/uncheck this box to enable/disable WPS functionality.
<b>Self Pin Code</b>	Displays the WPS PIN code of the device, used for PIN code WPS. You will be required to enter this PIN code into another WPS device for PIN code WPS. Click "Generate PIN" to generate a new WPS PIN code.
<b>Configure via Push Button</b>	Click "Start PBC" to activate WPS.
<b>Configure via Client Pin Code</b>	Enter the PIN code of another WPS device and click "Apply" to attempt to establish a WPS connection.

You can also activate WPS via hardware,

1. Press and hold the WPS button for 2 seconds to activate WPS.
2. WPS feature is enabled on your router when the WPS LED blinking **BLUE** light.

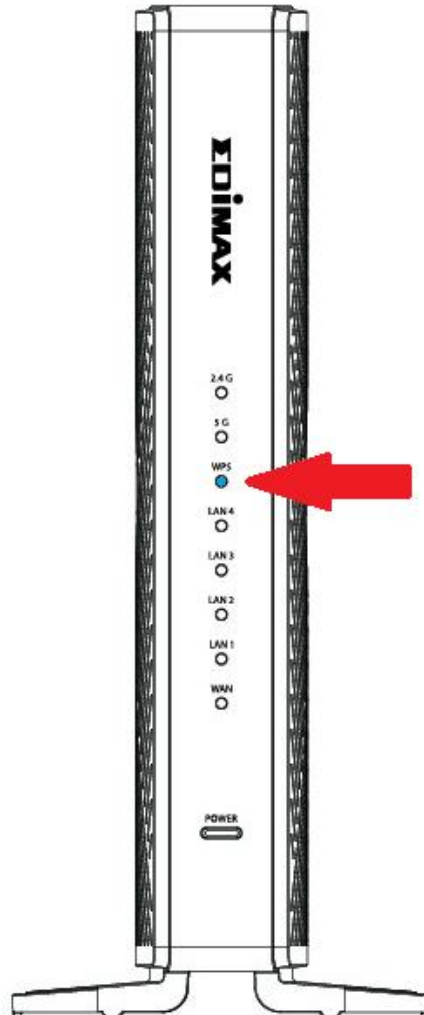

## VI. Administration

---

Centralized administration makes setup and management fast and easy. In this page you can check system information, system log and statistics etc..

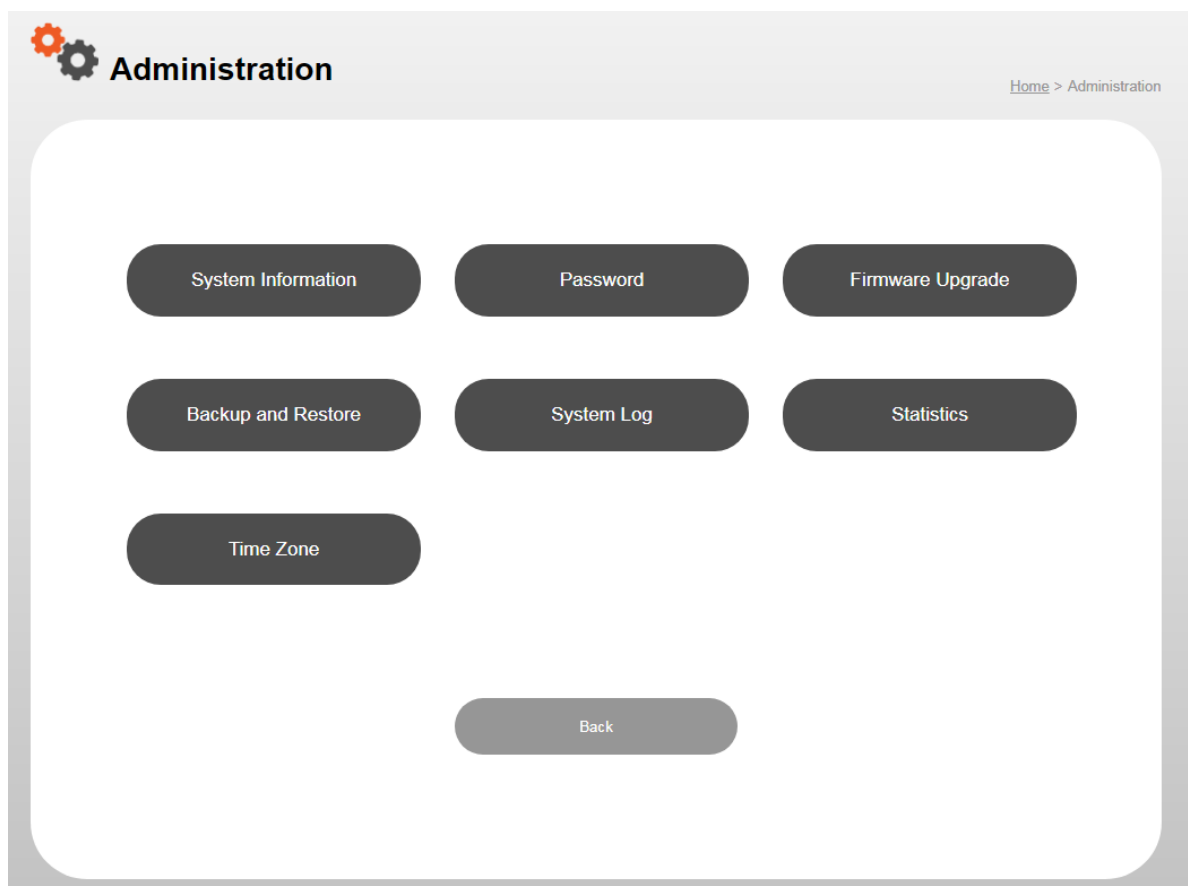

## VI-1. System Information

“System Information” page displays basic system information, internet information and Wi-Fi & guest 2.4GHz/5GHz information.

The screenshot shows a web interface for "System Information". At the top left is a gear icon and the title "System Information". At the top right is a breadcrumb trail: "Home > Administration > System Information". The main content area is divided into four sections: "System", "Internet", "Wi-Fi", and "Guest Wi-Fi".

**System**

Operation Time	0 Day, 18:20:58
Firmware Version	v1.0.1
Operation Mode	Router
Current Time	2019/12/05 11:39:28

**Internet**

WAN LAN

IP Address	192.168.10.70
Subnet Mask	255.255.255.128
Default Gateway	192.168.10.1
MAC Address	00:AB:CD:EF:AB:21

**Wi-Fi**

2.4GHz 5GHz

SSID	EDIMAX_20
Channel	11
Encryption Methods	WPA2 AES
BSSID	00:AB:CD:EF:AB:22
Connection Number	0

**Guest Wi-Fi**

2.4GHz 5GHz

SSID	
Channel	0
Encryption Methods	WPA2 AES
BSSID	00:00:00:00:00:00
Connection Number	0

Back



## VI-2. Password

In this page you can reset the password of your router.

Please follow the steps below to reset the password,

1. Enter the new password.
2. Confirm your password.
3. Click the “Apply” button to save the change.

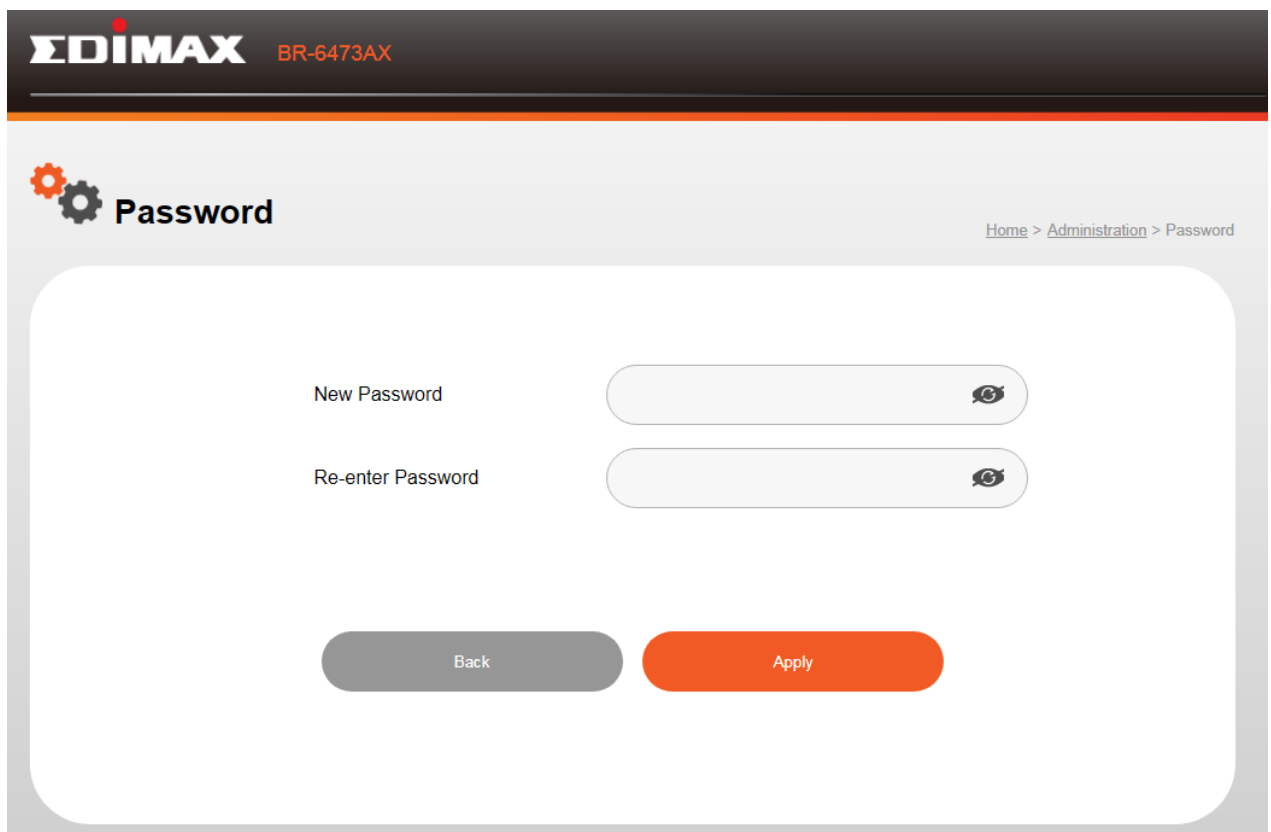

The screenshot shows the web interface for resetting the password on an EDIMAX BR-6473AX router. The page has a dark header with the EDIMAX logo and model number. Below the header, there is a navigation breadcrumb: Home > Administration > Password. The main content area contains two input fields: "New Password" and "Re-enter Password", both with toggle icons for visibility. At the bottom, there are two buttons: "Back" (grey) and "Apply" (orange).

### VI-3. Firmware Upgrade

You can upgrade firmware on router by either OTA or manual update.

Please follow the steps below to upgrade firmware.

1. Click “Check Version” to check if the current firmware is up to date or not.

- Select “Local File” to upload the firmware file to the router.

- Select Online Upgrade to update the firmware via OTA.

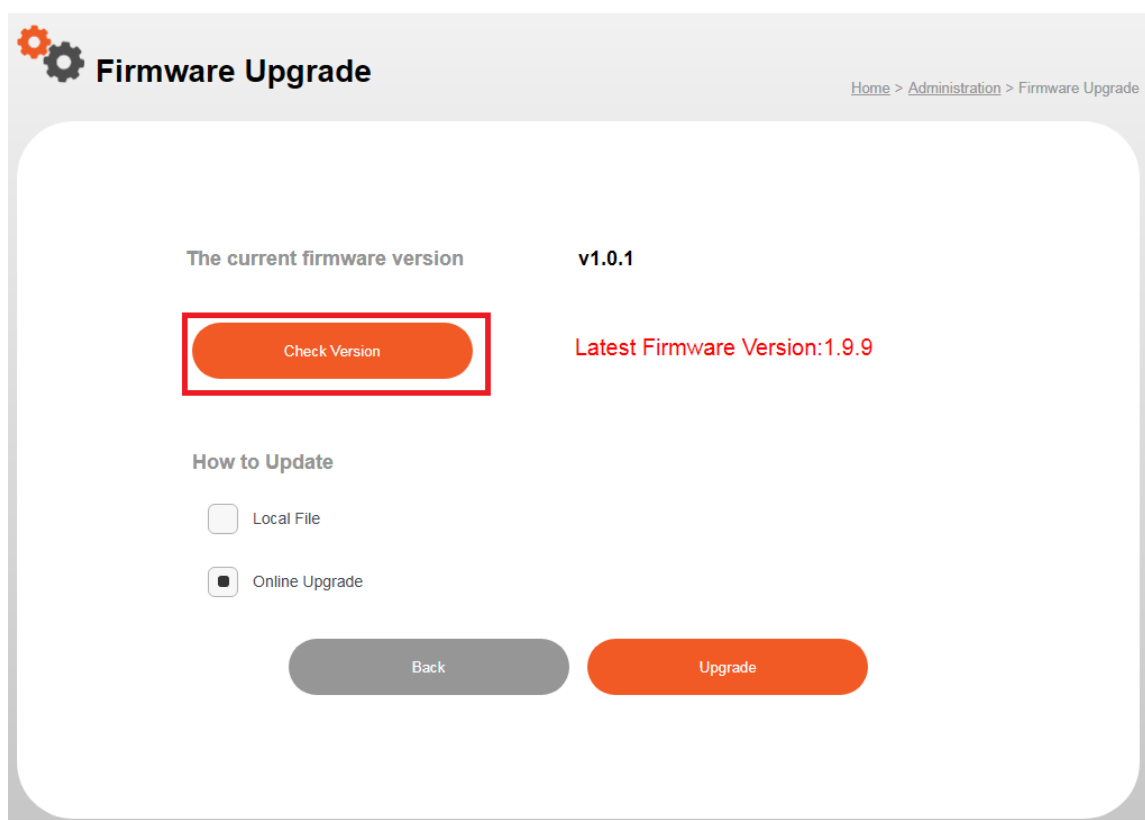

2. Click the “Upgrade” and “OK” button to start upgrading the firmware.

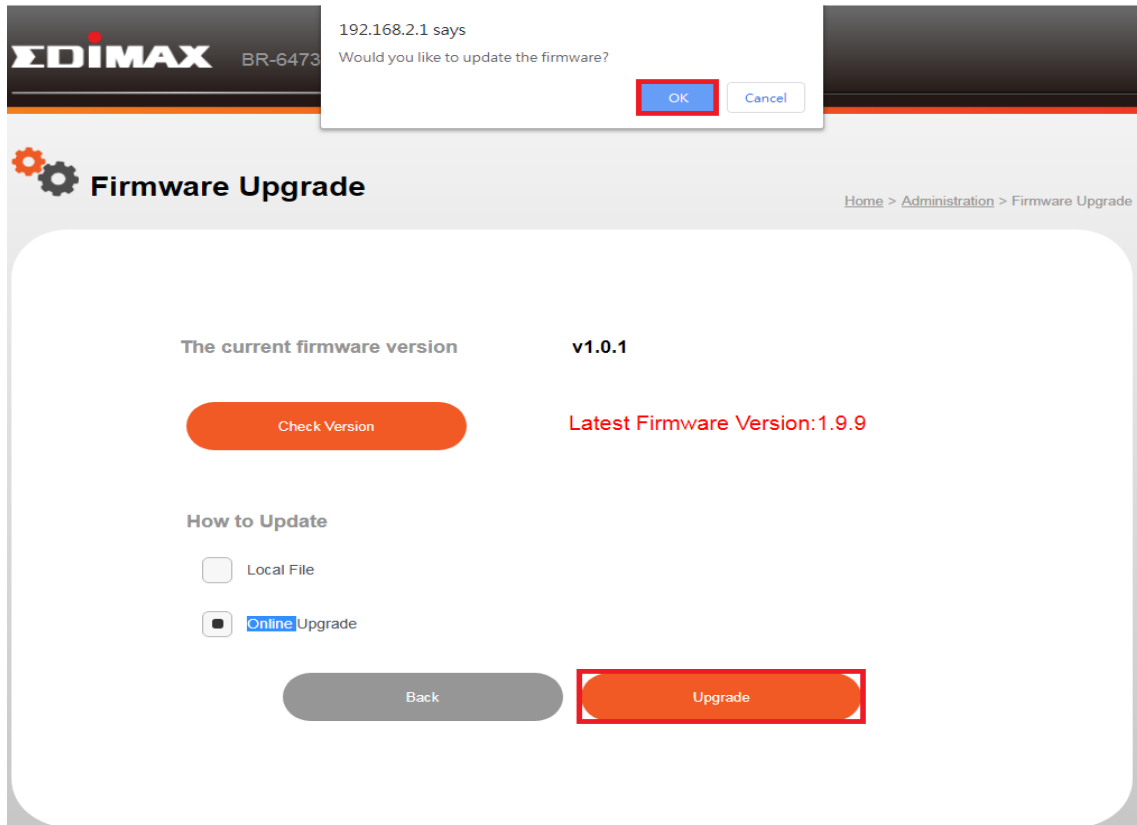

#### VI-4. Backup and Restore

In this page you can reset the router to factory settings, backup and restore all the settings on the router.

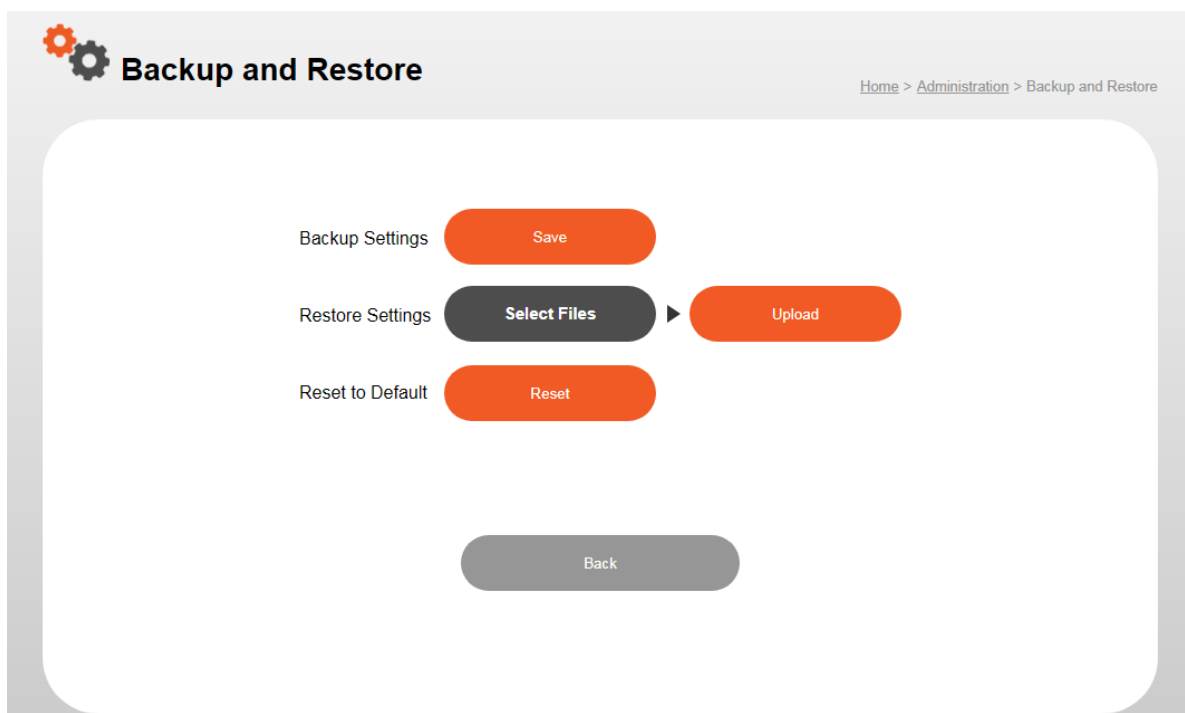

Please follow the steps below to back up and restore the settings on you router,

1. Click the “Save” button to backup all the settings.

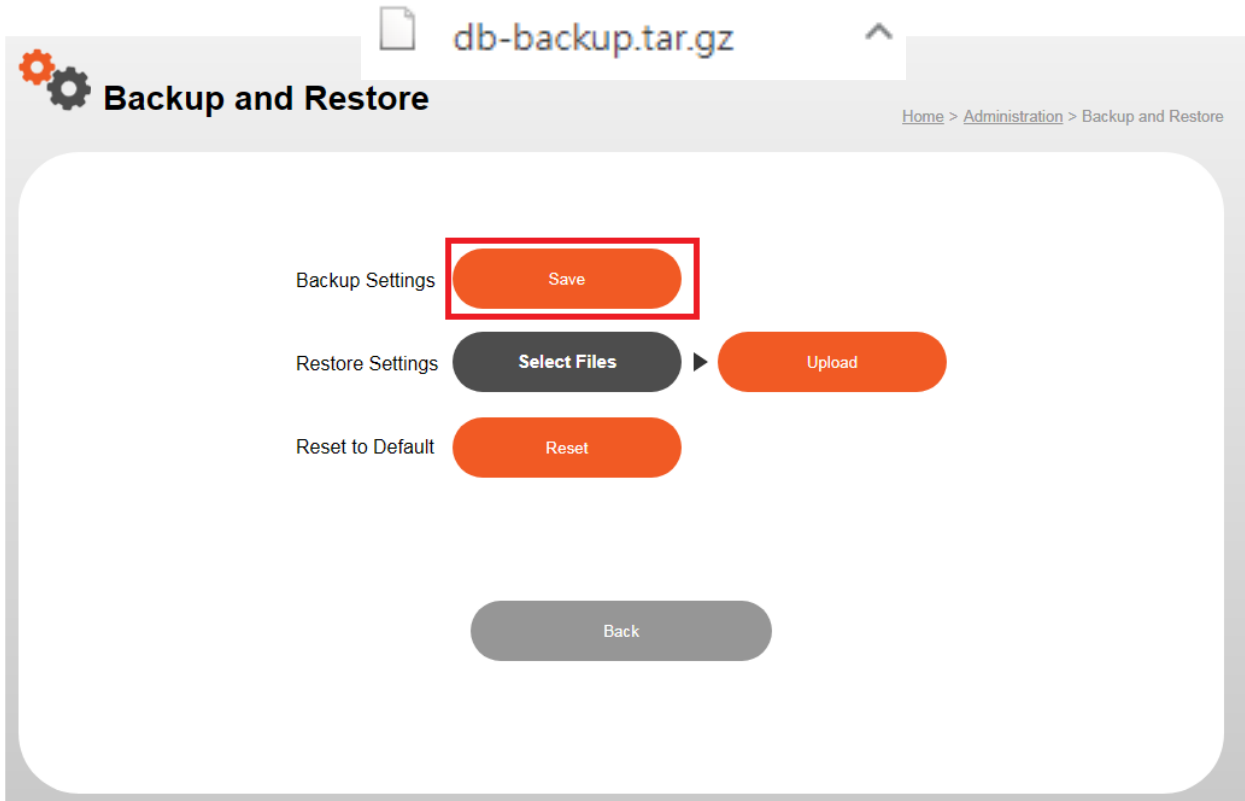

2. Click the “Select Files” button, and select the backup file that you want to upload.

3. Click the “Upload” button.

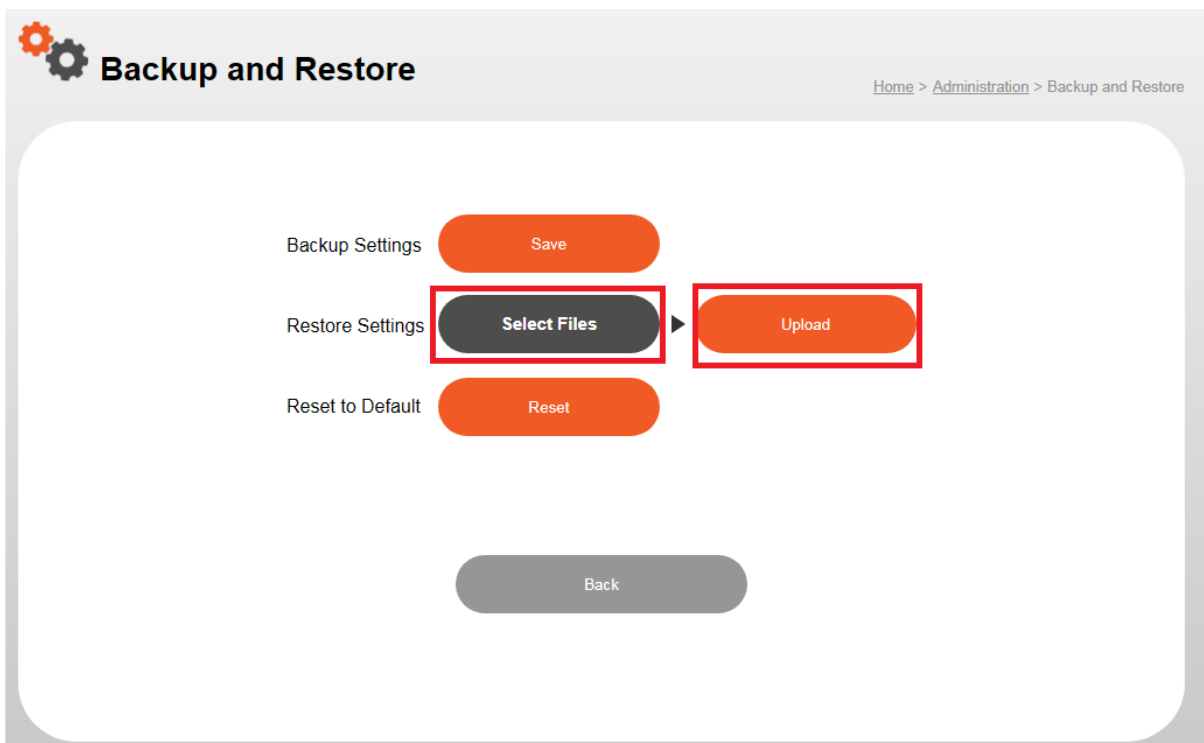

If you experience problems with your router, you can reset the device back to its factory settings.

There are 2 ways to reset the device.

### Hardware Reset:

1. Press and hold the reset button on the router for at least 5 seconds then release the button. Please wait a few minutes for the router to restart. When the device restarts, all settings will be reset.
2. Wait for the router to restart. The router is ready for setup when the power LED blinking **RED** light.

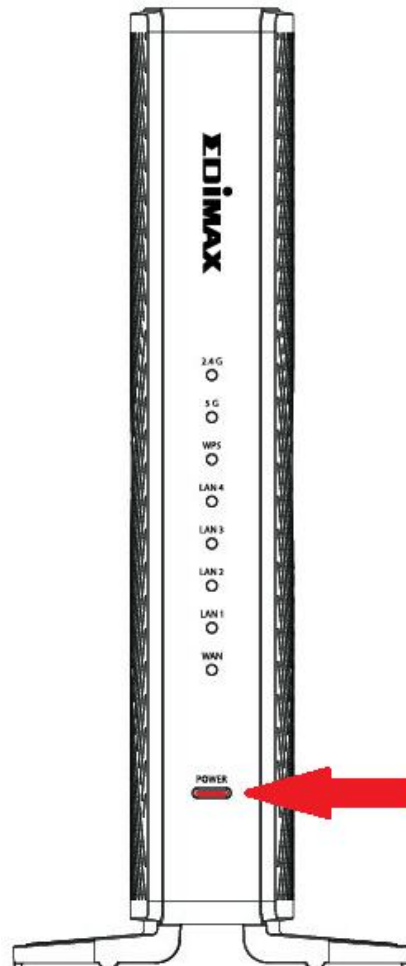

## Web-Based Setup Page:

Click the “Reset” and “OK” button to reset the router to factory settings.

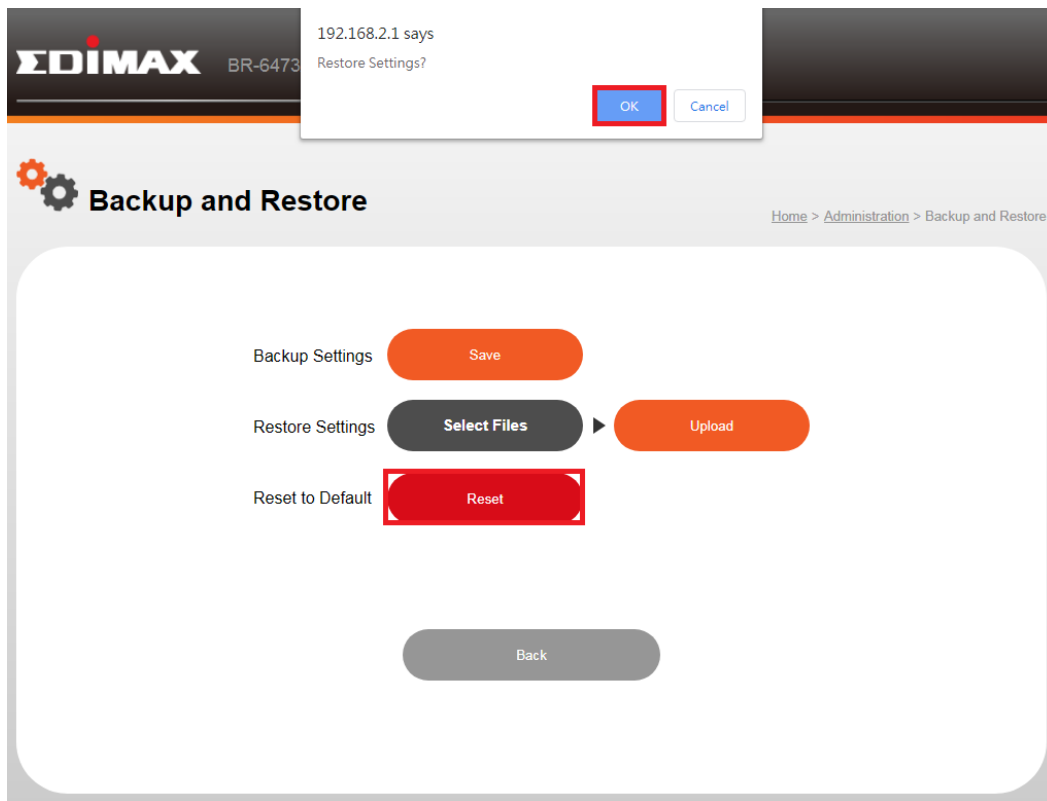

## VI-5. System Log

“System log” displays system operation information such as up time and connection processes. This information is useful for administrators.

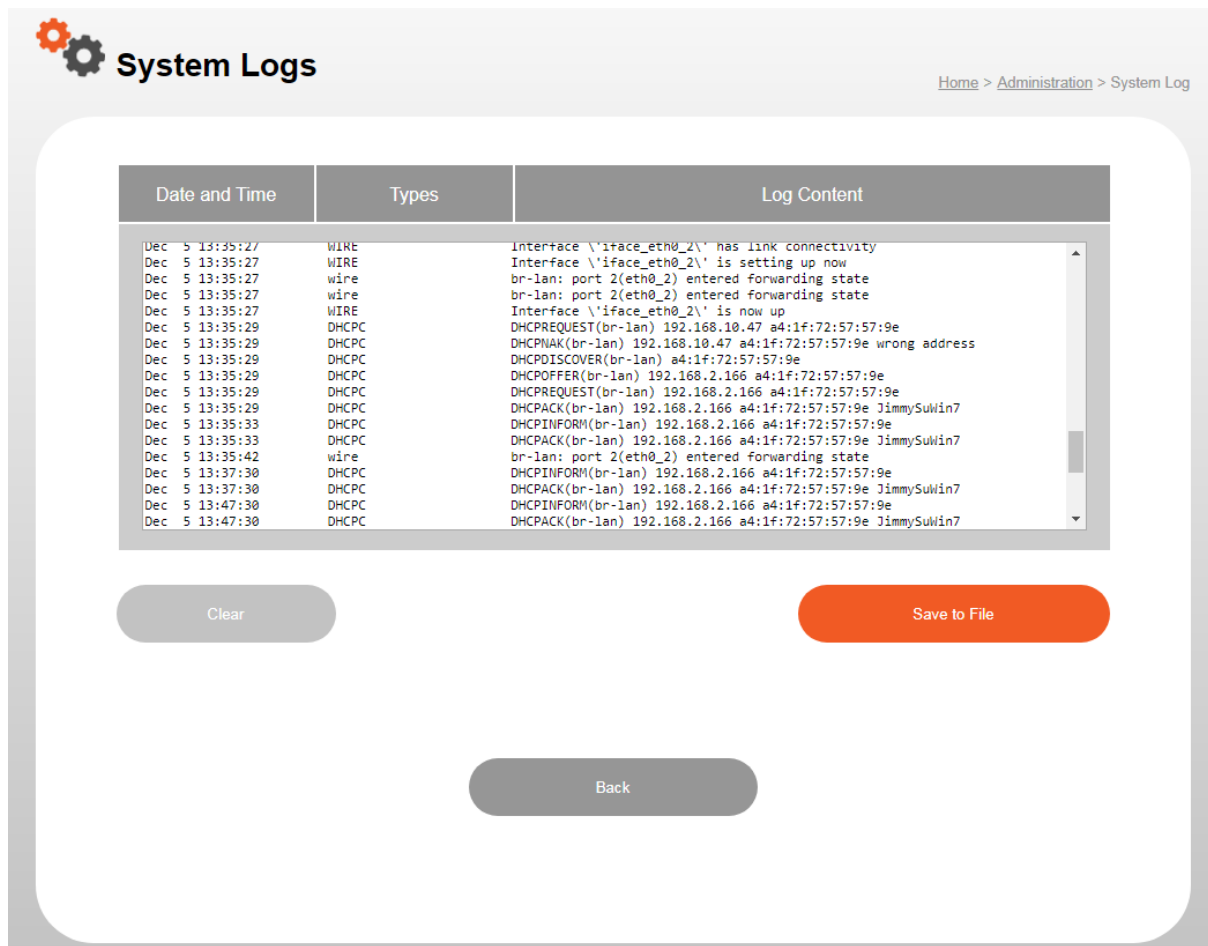

To backup the system log, please click the “Save to File” button and press “Save”.

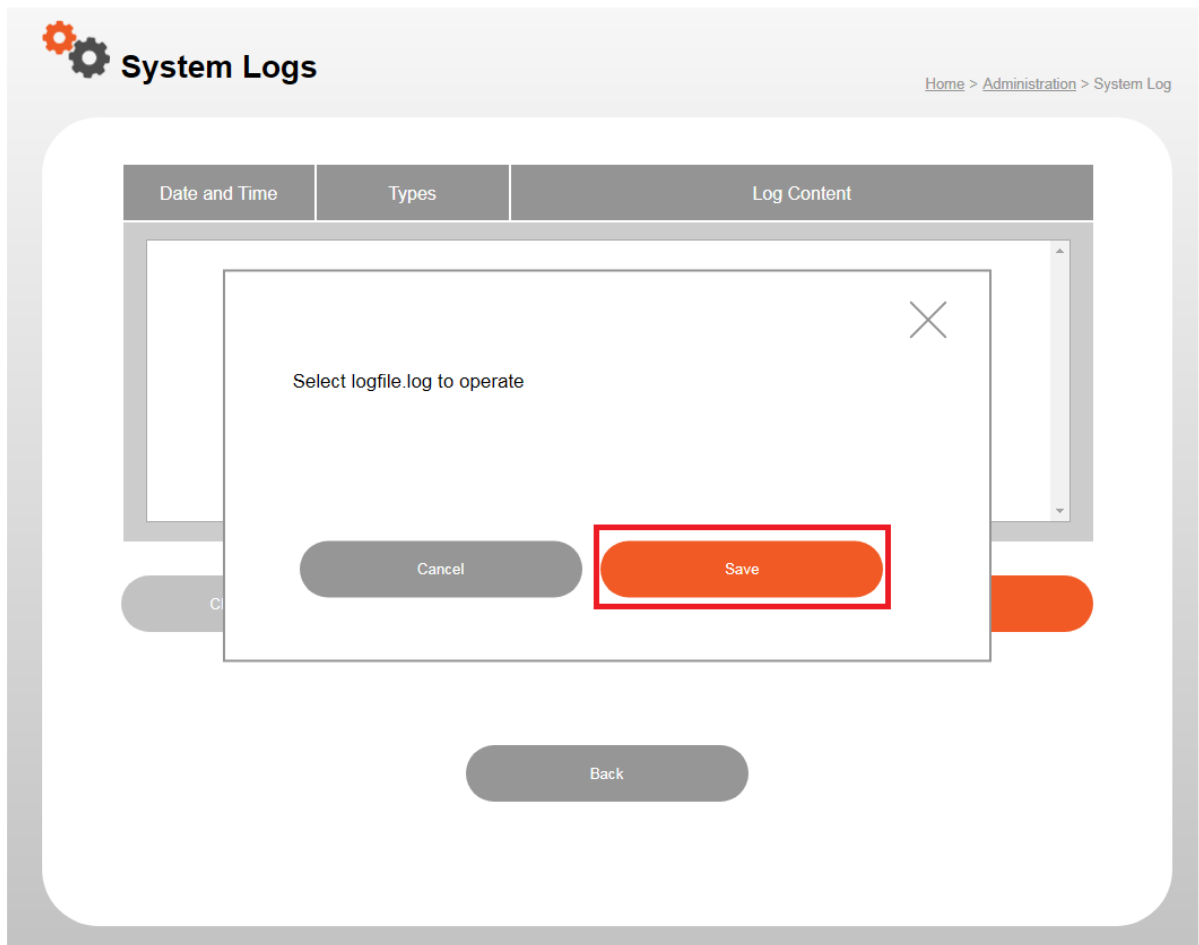

To clear the system log, please click the “Clear” button.

**System Logs** Home > Administration > System Log

Date and Time	Types	Log Content
Dec 5 13:35:27	WIRE	Interface \'iface_eth0_2\' has link connectivity
Dec 5 13:35:27	WIRE	Interface \'iface_eth0_2\' is setting up now
Dec 5 13:35:27	wire	br-lan: port 2(eth0_2) entered forwarding state
Dec 5 13:35:27	wire	br-lan: port 2(eth0_2) entered forwarding state
Dec 5 13:35:27	WIRE	Interface \'iface_eth0_2\' is now up
Dec 5 13:35:29	DHCPC	DHCPREQUEST(br-lan) 192.168.10.47 a4:1f:72:57:57:9e
Dec 5 13:35:29	DHCPC	DHCPNAK(br-lan) 192.168.10.47 a4:1f:72:57:57:9e wrong address
Dec 5 13:35:29	DHCPC	DHCPDISCOVER(br-lan) a4:1f:72:57:57:9e
Dec 5 13:35:29	DHCPC	DHCPOFFER(br-lan) 192.168.2.166 a4:1f:72:57:57:9e
Dec 5 13:35:29	DHCPC	DHCPREQUEST(br-lan) 192.168.2.166 a4:1f:72:57:57:9e
Dec 5 13:35:29	DHCPC	DHCPACK(br-lan) 192.168.2.166 a4:1f:72:57:57:9e JimmySulin7
Dec 5 13:35:33	DHCPC	DHCPINFORM(br-lan) 192.168.2.166 a4:1f:72:57:57:9e
Dec 5 13:35:33	DHCPC	DHCPACK(br-lan) 192.168.2.166 a4:1f:72:57:57:9e JimmySulin7
Dec 5 13:35:42	wire	br-lan: port 2(eth0_2) entered forwarding state
Dec 5 13:37:30	DHCPC	DHCPINFORM(br-lan) 192.168.2.166 a4:1f:72:57:57:9e
Dec 5 13:37:30	DHCPC	DHCPACK(br-lan) 192.168.2.166 a4:1f:72:57:57:9e JimmySulin7
Dec 5 13:47:30	DHCPC	DHCPINFORM(br-lan) 192.168.2.166 a4:1f:72:57:57:9e
Dec 5 13:47:30	DHCPC	DHCPACK(br-lan) 192.168.2.166 a4:1f:72:57:57:9e JimmySulin7

Buttons: **Clear** (highlighted), **Save to File**, **Back**

## VI-6. Statistic

Your router stats can be found in this page, such as Ethernet LAN/WAN, 2.4GHz/5GHz Wireless.

**Statistics** Home > Administration > Statistics

Interface	Send		Receive	
	Normal	Error	Normal	Error
Ethernet LAN	45588	0	36210	0
Ethernet WAN	7820	0	68124	0
2.4GHz Wireless	0	0	0	0
5GHz Wireless	0	0	0	0

Button: **Back**



## VI-7. Time Zone

Select the time zone of your country/region. If your country/region is not listed, please select another country/region whose time zone is the same as yours.

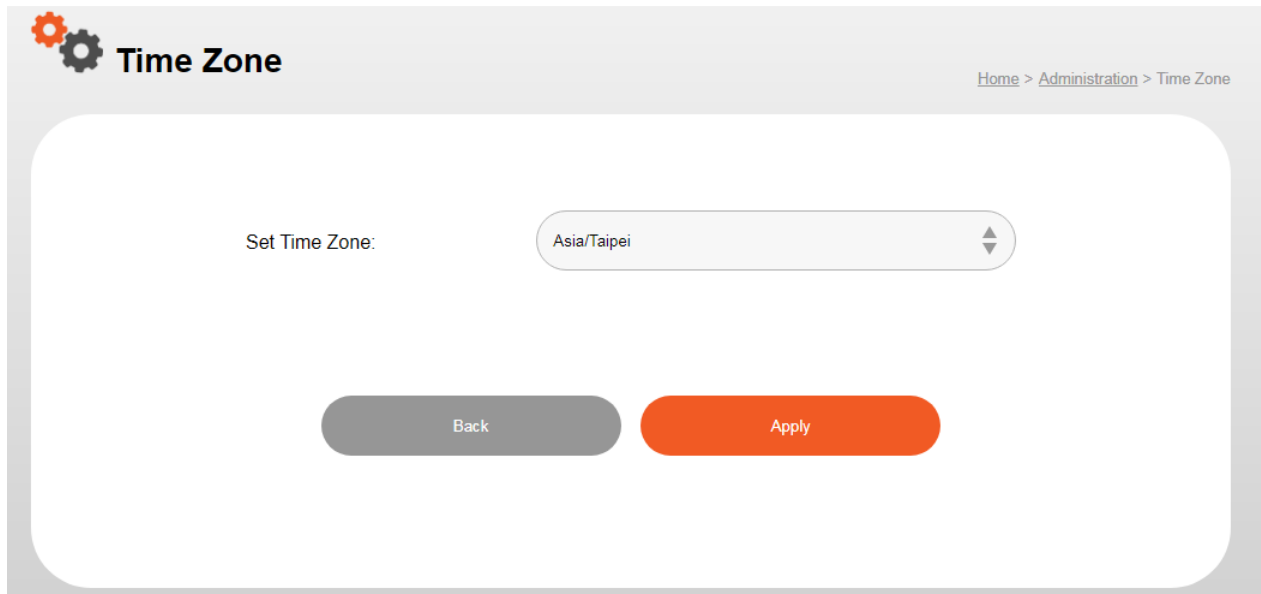

The screenshot shows the 'Time Zone' configuration page. At the top left, there is a gear icon and the text 'Time Zone'. At the top right, there is a breadcrumb trail: 'Home > Administration > Time Zone'. The main content area contains a label 'Set Time Zone:' followed by a dropdown menu currently displaying 'Asia/Taipei'. Below the dropdown are two buttons: a grey 'Back' button and an orange 'Apply' button.

## VII. Security

---

The router provides various security options, for example, access control and DMZ.

 **It is essential to configure security in order to prevent unauthorised access to your network.**

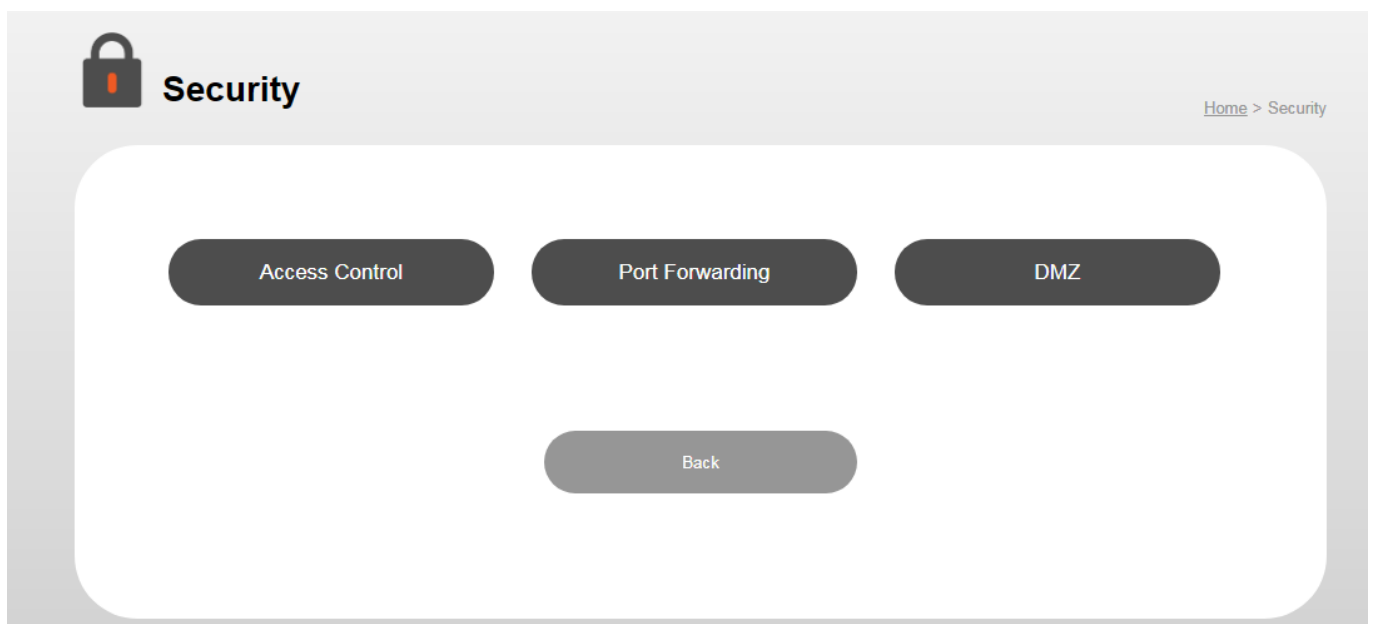

The screenshot shows the 'Security' configuration page. At the top left, there is a padlock icon and the text 'Security'. At the top right, there is a breadcrumb trail: 'Home > Security'. The main content area contains four buttons: 'Access Control', 'Port Forwarding', and 'DMZ' are arranged horizontally, and a 'Back' button is centered below them.

## VII-1. Access Control

MAC Access Control is a security feature that can help to prevent unauthorized users from connecting to your router.

This function allows you to define a list of network devices permitted to connect to the router. Devices are each identified by their unique MAC address. If a device not on the list of permitted MAC addresses attempts to connect to the router, it will be denied.

The Access Control panel displays information about MAC Access Control & MAC Access Control Groups and Groups and allows you to add or edit MAC Access Control & MAC Access Control Group settings.

The screenshot shows the 'Access Control' configuration page. At the top left is a lock icon and the title 'Access Control'. On the top right is a breadcrumb trail: 'Home > Security > Access Control'. The main configuration area includes:

- 'Access Control' with an 'Enable' checkbox.
- 'MAC Address' with a text input field containing 'Example: 74da38112233'.
- 'Comments' with a text input field.
- An orange 'Add' button.

Below this is a section titled 'Access Control List' with a dashed line separator. It contains a table with the following data:

MAC Address	Comments	Select
74:da:38:11:22:33	dddd	<input type="checkbox"/>

Below the table are two buttons: 'Delete Selected' and 'Delete All'. At the bottom of the panel are two buttons: 'Back' and 'Apply'.

## VII-2. Port Forwarding

A port forward opens specific ports on your router and is a way of making a computer network accessible to any networking application.

 **Port Forwarding** [Home](#) > [Security](#) > Port Forwarding

Port Forwarding  Enable

Local IP Address

Type

Port

Comments

■ Port Forwarding List

---

Local IP Address	Type	Port	Comments	Select
------------------	------	------	----------	--------

## VII-3. DMZ

DMZ Network exists to protect the hosts most vulnerable to attack and as a subnetwork containing an organization's exposed, outward-facing services. It acts as the exposed point to an untrusted networks, commonly the Internet.

Please follow the steps below to setup DMZ on your router,

1. Enable DMZ.
2. Enter the DMZ IP address.
3. Click the “Apply” button.

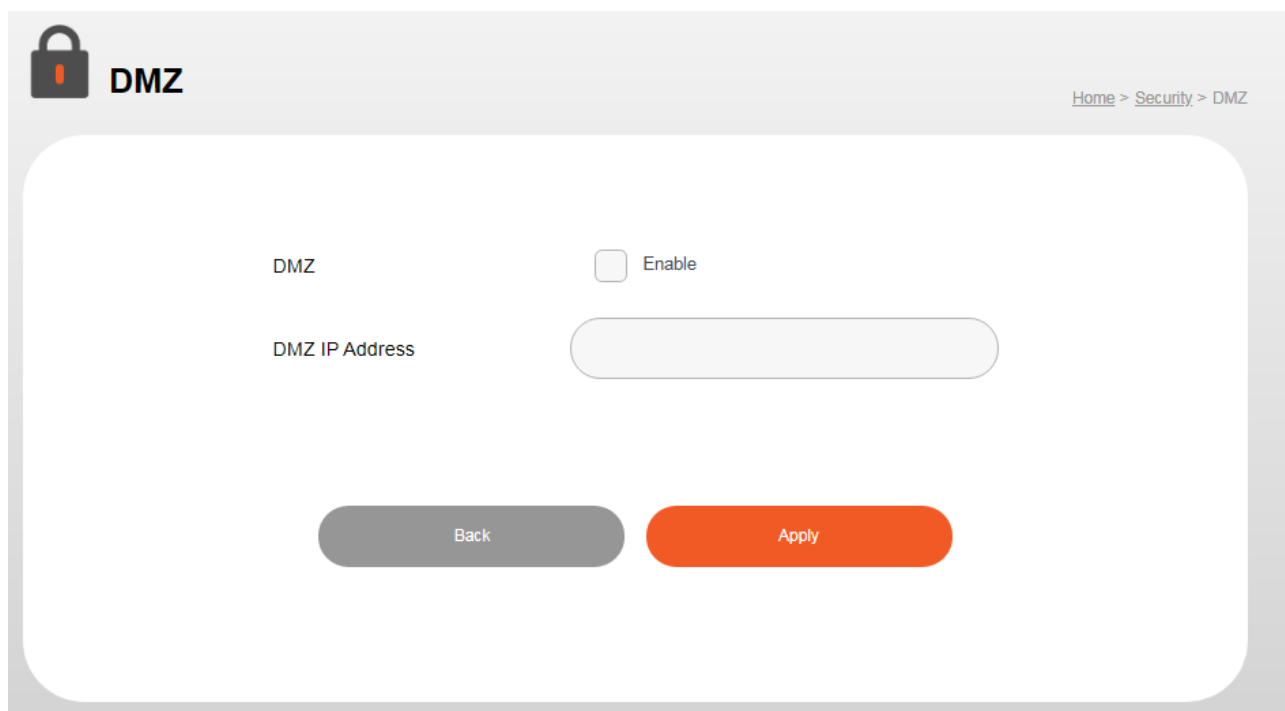

The screenshot shows a web interface for configuring DMZ. At the top left, there is a padlock icon and the text "DMZ". At the top right, there is a breadcrumb trail: "Home > Security > DMZ". The main content area contains a "DMZ" label with an unchecked checkbox and the text "Enable". Below this is a "DMZ IP Address" label followed by a large, empty, rounded rectangular input field. At the bottom of the form, there are two buttons: a grey "Back" button and an orange "Apply" button.

## COPYRIGHT

Copyright © Edimax Technology Co., Ltd. all rights reserved. No part of this publication may be reproduced, transmitted, transcribed, stored in a retrieval system, or translated into any language or computer language, in any form or by any means, electronic, mechanical, magnetic, optical, chemical, manual or otherwise, without the prior written permission from Edimax Technology Co., Ltd.

Edimax Technology Co., Ltd. makes no representations or warranties, either expressed or implied, with respect to the contents hereof and specifically disclaims any warranties, merchantability, or fitness for any particular purpose. Any software described in this manual is sold or licensed as is. Should the programs prove defective following their purchase, the buyer (and not this company, its distributor, or its dealer) assumes the entire cost of all necessary servicing, repair, and any incidental or consequential damages resulting from any defect in the software. Edimax Technology Co., Ltd. reserves the right to revise this publication and to make changes from time to time in the contents hereof without the obligation to notify any person of such revision or changes.

The product you have purchased and the setup screen may appear slightly different from those shown in this QIG. The software and specifications are subject to change without notice. Please visit our website [www.edimax.com](http://www.edimax.com) for updates. All brand and product names mentioned in this manual are trademarks and/or registered trademarks of their respective holders.

	AT	BE	BG	HR	CY	CZ	DK
	EE	FI	FR	DE	EL	HU	IE
	IT	LV	LT	LU	MT	NL	PL
	PT	RO	SK	SI	ES	SE	UK

The device is restricted to indoor use only when operating in the 5150 to 5350 MHz frequency range.

## **Federal Communication Commission Interference Statement**

This equipment has been tested and found to comply with the limits for a Class B digital device, pursuant to Part 15 of FCC Rules. These limits are designed to provide reasonable protection against harmful interference in a residential installation. This equipment generates, uses, and can radiate radio frequency energy and, if not installed and used in accordance with the instructions, may cause harmful interference to radio communications. However, there is no guarantee that interference will not occur in a particular installation. If this equipment does cause harmful interference to radio or television reception, which can be determined by turning the equipment off and on, the user is encouraged to try to correct the interference by one or more of the following measures:

1. Reorient or relocate the receiving antenna.
2. Increase the separation between the equipment and receiver.
3. Connect the equipment into an outlet on a circuit different from that to which the receiver is connected.
4. Consult the dealer or an experienced radio technician for help.

### **FCC Caution**

This device and its antenna must not be co-located or operating in conjunction with any other antenna or transmitter. This device complies with Part 15 of the FCC Rules. Operation is subject to the following two conditions: (1) this device may not cause harmful interference, and (2) this device must accept any interference received, including interference that may cause undesired operation. Any changes or modifications not expressly approved by the party responsible for compliance could void the authority to operate equipment.

### **Federal Communications Commission (FCC) Radiation Exposure Statement**

This equipment complies with FCC radiation exposure set forth for an uncontrolled environment. In order to avoid the possibility of exceeding the FCC radio frequency exposure limits, human proximity to the antenna shall not be less than 2.5cm (1 inch) during normal operation.

The equipment version marketed in US is restricted to usage of the channels 1-11 only. This equipment is restricted to *indoor* use when operated in the 5.15 to 5.25 GHz frequency range.

### **Safety**

This equipment is designed with the utmost care for the safety of those who install and use it. However, special attention must be paid to the dangers of electric shock and static electricity when working with electrical equipment. All guidelines of this and of the computer manufacture must therefore be allowed at all times to ensure the safe use of the equipment.

### **EU Countries Intended for Use**

The ETSI version of this device is intended for home and office use in Austria, Belgium, Bulgaria, Cyprus, Czech, Denmark, Estonia, Finland, France, Germany, Greece, Hungary, Ireland, Italy, Latvia, Lithuania, Luxembourg, Malta, Netherlands, Poland, Portugal, Romania, Slovakia, Slovenia, Spain, Sweden, Turkey, and United Kingdom. The ETSI version of this device is also authorized for use in EFTA member states: Iceland, Liechtenstein, Norway, and Switzerland.

### **EU Countries Not Intended for Use**

None

## EU Declaration of Conformity

- English:** This equipment is in compliance with the essential requirements and other relevant provisions of Directive 2014/53/EU, 2014/35/EU.
- Français:** Cet équipement est conforme aux exigences essentielles et autres dispositions de la directive 2014/53/EU, 2014/35/EU.
- Čeština:** Toto zařízení je v souladu se základními požadavky a ostatními příslušnými ustanoveními směrnic 2014/53/EU, 2014/35/EU.
- Polski:** Urządzenie jest zgodne z ogólnymi wymaganiami oraz szczególnymi warunkami określonymi Dyrektywą UE 2014/53/EU, 2014/35/EU.
- Română:** Acest echipament este în conformitate cu cerințele esențiale și alte prevederi relevante ale Directivei 2014/53/UE, 2014/35/UE.
- Русский:** Это оборудование соответствует основным требованиям и положениям Директивы 2014/53/EU, 2014/35/EU.
- Magyar:** Ez a berendezés megfelel az alapvető követelményeknek és más vonatkozó irányelveknek (2014/53/EU, 2014/35/EU).
- Türkçe:** Bu cihaz 2014/53/EU, 2014/35/EU direktifleri zorunlu istekler ve diğer hükümlerle ile uyumludur.
- Українська:** Обладнання відповідає вимогам і умовам директиви 2014/53/EU, 2014/35/EU.
- Slovenčina:** Toto zariadenie spĺňa základné požiadavky a ďalšie príslušné ustanovenia smerníc 2014/53/EU, 2014/35/EU.
- Deutsch:** Dieses Gerät erfüllt die Voraussetzungen gemäß den Richtlinien 2014/53/EU, 2014/35/EU.
- Español:** El presente equipo cumple los requisitos esenciales de la Directiva 2014/53/EU, 2014/35/EU.
- Italiano:** Questo apparecchio è conforme ai requisiti essenziali e alle altre disposizioni applicabili della Direttiva 2014/53/EU, 2014/35/UE.
- Nederlands:** Dit apparaat voldoet aan de essentiële eisen en andere van toepassing zijnde bepalingen van richtlijn 2014/53/EU, 2014/35/EU.
- Português:** Este equipamento cumpre os requisitos essenciais da Directiva 2014/53/EU, 2014/35/EU.
- Norsk:** Dette utstyret er i samsvar med de viktigste kravene og andre relevante regler i Direktiv 2014/53/EU, 2014/35/EU.
- Svenska:** Denna utrustning är i överensstämmelse med de väsentliga kraven och övriga relevanta bestämmelser i direktiv 2014/53/EU, 2014/35/EU.
- Dansk:** Dette udstyr er i overensstemmelse med de væsentligste krav og andre relevante forordninger i direktiv 2014/53/EU, 2014/35/EU.
- suomen kieli:** Tämä laite täyttää direktiivien 2014/53/EU, 2014/35/EU. oleelliset vaatimukset ja muut asiaankuuluvat määräykset.

FOR USE IN 



---

### WEEE Directive & Product Disposal



At the end of its serviceable life, this product should not be treated as household or general waste. It should be handed over to the applicable collection point for the recycling of electrical and electronic equipment, or returned to the supplier for disposal.

## Declaration of Conformity

We, Edimax Technology Co., Ltd., declare under our sole responsibility, that the equipment described below complies with the requirements of the European Radio Equipment directives.

**Equipment: AX3000 Dual-Band Router**  
**Model No.: BR-6473AX**

The following European standards for essential requirements have been followed:

### Directives 2014/53/EU

Spectrum : EN 300 328 V2.1.1 (2016-11)  
EN 301 893 V2.1.1 (2017-05)  
EMC : EN 301 489-1 V2.2.0 (2017-03)  
EN 301 489-17 V3.2.0 (2017-03)  
EMF : EN 62311:2008  
Safety (LVD) : IEC 62368-1:2014 (2<sup>nd</sup> Edition) and/or EN 62368-1:2014+A11:2017

Edimax Technology Europe B.V.  
Fijenhof 2,  
5652 AE Eindhoven,  
The Netherlands

a company of :  
Edimax Technology Co., Ltd.  
No. 278, Xinhua 1st Rd.,  
Neihu Dist., Taipei City,  
Taiwan

### Signature:

Printed Name: David Huang  
Title: Director



Date of Signature: Dec., 2019

Signature: \_\_\_\_\_

A handwritten signature in black ink, appearing to read 'Albert Chang', written over a horizontal line.

Printed Name: Albert Chang

Title: Director

Edimax Technology Co., Ltd.



## Notice According to GNU General Public License Version 2

This product includes software that is subject to the GNU General Public License version 2. The program is free software and distributed without any warranty of the author. We offer, valid for at least three years, to give you, for a charge no more than the costs of physically performing source distribution, a complete machine-readable copy of the corresponding source code.

Das Produkt beinhaltet Software, die den Bedingungen der GNU/GPL-Version 2 unterliegt. Das Programm ist eine sog. „Free Software“, der Autor stellt das Programm ohne irgendeine Gewährleistungen zur Verfügung. Wir bieten Ihnen für einen Zeitraum von drei Jahren an, eine vollständige maschinenlesbare Kopie des Quelltextes der Programme zur Verfügung zu stellen – zu nicht höheren Kosten als denen, die durch den physikalischen Kopiervorgang anfallen.

### GNU GENERAL PUBLIC LICENSE Version 2, June 1991

Copyright (C) 1989, 1991 Free Software Foundation, Inc. 51 Franklin Street, Fifth Floor, Boston, MA 02110-1301, USA  
Everyone is permitted to copy and distribute verbatim copies of this license document, but changing it is not allowed.

#### Preamble

The licenses for most software are designed to take away your freedom to share and change it. By contrast, the GNU General Public License is intended to guarantee your freedom to share and change free software--to make sure the software is free for all its users. This General Public License applies to most of the Free Software Foundation's software and to any other program whose authors commit to using it. (Some other Free Software Foundation software is covered by the GNU Lesser General Public License instead.) You can apply it to your programs, too.

When we speak of free software, we are referring to freedom, not price. Our General Public Licenses are designed to make sure that you have the freedom to distribute copies of free software (and charge for this service if you wish), that you receive source code or can get it if you want it, that you can change the software or use pieces of it in new free programs; and that you know you can do these things.

To protect your rights, we need to make restrictions that forbid anyone to deny you these rights or to ask you to surrender the rights. These restrictions translate to certain responsibilities for you if you distribute copies of the software, or if you modify it.

For example, if you distribute copies of such a program, whether gratis or for a fee, you must give the recipients all the rights that you have. You must make sure that they, too, receive or can get the source code. And you must show them these terms so they know their rights.

We protect your rights with two steps: (1) copyright the software, and (2) offer you this license which gives you legal permission to copy, distribute and/or modify the software.

Also, for each author's protection and ours, we want to make certain that everyone understands that there is no warranty for this free software. If the software is modified by someone else and passed on, we want its recipients to know that what they have is not the original, so that any problems introduced by others will not reflect on the original authors' reputations.

Finally, any free program is threatened constantly by software patents. We wish to avoid the danger that redistributors of a free program will individually obtain patent licenses, in effect making the program proprietary. To prevent this, we have made it clear that any patent must be licensed for everyone's free use or not licensed at all.

The precise terms and conditions for copying, distribution and modification follow.

#### TERMS AND CONDITIONS FOR COPYING, DISTRIBUTION AND MODIFICATION

0. This License applies to any program or other work which contains a notice placed by the copyright holder saying it may be distributed under the terms of this General Public License. The "Program", below, refers to any such program or work, and a "work based on the Program" means either the Program or any derivative work under copyright law: that is to say, a work containing the Program or a portion of it, either verbatim or with modifications and/or translated into another language. (Hereinafter, translation is included without limitation in the term "modification".) Each licensee is addressed as "you".

Activities other than copying, distribution and modification are not covered by this License; they are outside its scope. The act of running the Program is not restricted, and the output from the Program is covered only if its contents constitute a work based on the Program (independent of having been made by running the Program). Whether that is true depends on what the Program does.

1. You may copy and distribute verbatim copies of the Program's source code as you receive it, in any medium, provided that you conspicuously and appropriately publish on each copy an appropriate copyright notice and disclaimer of warranty; keep

intact all the notices that refer to this License and to the absence of any warranty; and give any other recipients of the Program a copy of this License along with the Program.

You may charge a fee for the physical act of transferring a copy, and you may at your option offer warranty protection in exchange for a fee.

2. You may modify your copy or copies of the Program or any portion of it, thus forming a work based on the Program, and copy and distribute such modifications or work under the terms of Section 1 above, provided that you also meet all of these conditions:

- a) You must cause the modified files to carry prominent notices stating that you changed the files and the date of any change.
- b) You must cause any work that you distribute or publish, that in whole or in part contains or is derived from the Program or any part thereof, to be licensed as a whole at no charge to all third parties under the terms of this License.
- c) If the modified program normally reads commands interactively when run, you must cause it, when started running for such interactive use in the most ordinary way, to print or display an announcement including an appropriate copyright notice and a notice that there is no warranty (or else, saying that you provide a warranty) and that users may redistribute the program under these conditions, and telling the user how to view a copy of this License. (Exception: if the Program itself is interactive but does not normally print such an announcement, your work based on the Program is not required to print an announcement.)

These requirements apply to the modified work as a whole. If identifiable sections of that work are not derived from the Program, and can be reasonably considered independent and separate works in themselves, then this License, and its terms, do not apply to those sections when you distribute them as separate works. But when you distribute the same sections as part of a whole which is a work based on the Program, the distribution of the whole must be on the terms of this License, whose permissions for other licensees extend to the entire whole, and thus to each and every part regardless of who wrote it.

Thus, it is not the intent of this section to claim rights or contest your rights to work written entirely by you; rather, the intent is to exercise the right to control the distribution of derivative or collective works based on the Program.

In addition, mere aggregation of another work not based on the Program with the Program (or with a work based on the Program) on a volume of a storage or distribution medium does not bring the other work under the scope of this License.

3. You may copy and distribute the Program (or a work based on it, under Section 2) in object code or executable form under the terms of Sections 1 and 2 above provided that you also do one of the following:

- a) Accompany it with the complete corresponding machine-readable source code, which must be distributed under the terms of Sections 1 and 2 above on a medium customarily used for software interchange; or,
- b) Accompany it with a written offer, valid for at least three years, to give any third party, for a charge no more than your cost of physically performing source distribution, a complete machine-readable copy of the corresponding source code, to be distributed under the terms of Sections 1 and 2 above on a medium customarily used for software interchange; or,
- c) Accompany it with the information you received as to the offer to distribute corresponding source code. (This alternative is allowed only for noncommercial distribution and only if you received the program in object code or executable form with such an offer, in accord with Subsection b above.)

The source code for a work means the preferred form of the work for making modifications to it. For an executable work, complete source code means all the source code for all modules it contains, plus any associated interface definition files, plus the scripts used to control compilation and installation of the executable. However, as a special exception, the source code distributed need not include anything that is normally distributed (in either source or binary form) with the major components (compiler, kernel, and so on) of the operating system on which the executable runs, unless that component itself accompanies the executable.

If distribution of executable or object code is made by offering access to copy from a designated place, then offering equivalent access to copy the source code from the same place counts as distribution of the source code, even though third parties are not compelled to copy the source along with the object code.

4. You may not copy, modify, sublicense, or distribute the Program except as expressly provided under this License. Any attempt otherwise to copy, modify, sublicense or distribute the Program is void, and will automatically terminate your rights under this License. However, parties who have received copies, or rights, from you under this License will not have their licenses terminated so long as such parties remain in full compliance.

5. You are not required to accept this License, since you have not signed it. However, nothing else grants you permission to modify or distribute the Program or its derivative works. These actions are prohibited by law if you do not accept this License. Therefore, by modifying or distributing the Program (or any work based on the Program), you indicate your acceptance of this License to do so, and all its terms and conditions for copying, distributing or modifying the Program or works based on it.

6. Each time you redistribute the Program (or any work based on the Program), the recipient automatically receives a license from the original licensor to copy, distribute or modify the Program subject to these terms and conditions. You may not impose any further restrictions on the recipients' exercise of the rights granted herein. You are not responsible for enforcing compliance by third parties to this License.

7. If, as a consequence of a court judgment or allegation of patent infringement or for any other reason (not limited to patent issues), conditions are imposed on you (whether by court order, agreement or otherwise) that contradict the conditions of this License, they do not excuse you from the conditions of this License. If you cannot distribute so as to satisfy simultaneously your obligations under this License and any other pertinent obligations, then as a consequence you may not distribute the Program at all. For example, if a patent license would not permit royalty-free redistribution of the Program by all those who receive copies directly or indirectly through you, then the only way you could satisfy both it and this License would be to refrain entirely from distribution of the Program.

If any portion of this section is held invalid or unenforceable under any particular circumstance, the balance of the section is intended to apply and the section as a whole is intended to apply in other circumstances.

It is not the purpose of this section to induce you to infringe any patents or other property right claims or to contest validity of any such claims; this section has the sole purpose of protecting the integrity of the free software distribution system, which is implemented by public license practices. Many people have made generous contributions to the wide range of software distributed through that system in reliance on consistent application of that system; it is up to the author/donor to decide if he or she is willing to distribute software through any other system and a licensee cannot impose that choice.

This section is intended to make thoroughly clear what is believed to be a consequence of the rest of this License.

8. If the distribution and/or use of the Program is restricted in certain countries either by patents or by copyrighted interfaces, the original copyright holder who places the Program under this License may add an explicit geographical distribution limitation excluding those countries, so that distribution is permitted only in or among countries not thus excluded. In such case, this License incorporates the limitation as if written in the body of this License.

9. The Free Software Foundation may publish revised and/or new versions of the General Public License from time to time. Such new versions will be similar in spirit to the present version, but may differ in detail to address new problems or concerns.

Each version is given a distinguishing version number. If the Program specifies a version number of this License which applies to it and "any later version", you have the option of following the terms and conditions either of that version or of any later version published by the Free Software Foundation. If the Program does not specify a version number of this License, you may choose any version ever published by the Free Software Foundation.

10. If you wish to incorporate parts of the Program into other free programs whose distribution conditions are different, write to the author to ask for permission. For software which is copyrighted by the Free Software Foundation, write to the Free Software Foundation; we sometimes make exceptions for this. Our decision will be guided by the two goals of preserving the free status of all derivatives of our free software and of promoting the sharing and reuse of software generally.

#### **NO WARRANTY**

11. BECAUSE THE PROGRAM IS LICENSED FREE OF CHARGE, THERE IS NO WARRANTY FOR THE PROGRAM, TO THE EXTENT PERMITTED BY APPLICABLE LAW. EXCEPT WHEN OTHERWISE STATED IN WRITING THE COPYRIGHT HOLDERS AND/OR OTHER PARTIES PROVIDE THE PROGRAM "AS IS" WITHOUT WARRANTY OF ANY KIND, EITHER EXPRESSED OR IMPLIED, INCLUDING, BUT NOT LIMITED TO, THE IMPLIED WARRANTIES OF MERCHANTABILITY AND FITNESS FOR A PARTICULAR PURPOSE. THE ENTIRE RISK AS TO THE QUALITY AND PERFORMANCE OF THE PROGRAM IS WITH YOU. SHOULD THE PROGRAM PROVE DEFECTIVE, YOU ASSUME THE COST OF ALL NECESSARY SERVICING, REPAIR OR CORRECTION.

12. IN NO EVENT UNLESS REQUIRED BY APPLICABLE LAW OR AGREED TO IN WRITING WILL ANY COPYRIGHT HOLDER, OR ANY OTHER PARTY WHO MAY MODIFY AND/OR REDISTRIBUTE THE PROGRAM AS PERMITTED ABOVE, BE LIABLE TO YOU FOR DAMAGES, INCLUDING ANY GENERAL, SPECIAL, INCIDENTAL OR CONSEQUENTIAL DAMAGES ARISING OUT OF THE USE OR INABILITY TO USE THE PROGRAM (INCLUDING BUT NOT LIMITED TO LOSS OF DATA OR DATA BEING RENDERED INACCURATE OR LOSSES SUSTAINED BY YOU OR THIRD PARTIES OR A FAILURE OF THE PROGRAM TO OPERATE WITH ANY OTHER PROGRAMS), EVEN IF SUCH HOLDER OR OTHER PARTY HAS BEEN ADVISED OF THE POSSIBILITY OF SUCH DAMAGES.