

# Sound Bar

## Operating Instructions

### speaker.

- If the speaker system is being used in combination with a TV, VCR, or tape deck, noise may result and picture quality may suffer. In such a case, place the speaker system away from the TV, VCR, or tape deck.
- Use caution when placing the speaker system on a surface that has been specially treated (with wax, oil, polish, etc.), as staining or discoloration of the surface may result.
- Take care to avoid any possible injury from the corners of the bar speaker.

### On operation

Before connecting other equipment, be sure to turn off and unplug the speaker system.

### If you encounter color irregularity on a nearby TV screen

- Color irregularities may be observed on certain types of TV.
- If color irregularity is observed... Turn off the TV, then turn it on again after 15 to 30 minutes.
  - If color irregularity is observed again... Place the speaker system further away from the TV.

### On cleaning

- Clean the speaker system with a soft, dry cloth. Do not use any type of abrasive pad, scouring powder, or solvent such as alcohol or benzene.

If you have any questions or problems concerning your speaker system, please consult your nearest Sony dealer.

## About These Operating Instructions

- The instructions in these Operating Instructions describe the controls on the remote control.
- Some illustrations are presented as conceptual drawings, and may be different from the actual products.
- Characters in brackets [ ] appear in the front panel display.



5-034-775-11 (2)

HT-S400

## WARNING

Do not install the speaker system in a confined space, such as a bookcase or built-in cabinet.

To reduce the risk of fire, do not cover the ventilation opening of the speaker system with newspapers, tablecloths, curtains, etc. Do not expose the speaker system to naked flame sources (for example, lighted candles).

To reduce the risk of fire or electric shock, do not expose this speaker system to dripping or splashing, and do not place objects filled with liquids, such as vases, on the speaker system.

The speaker system is not disconnected from the mains as long as it is connected to the AC outlet, even if the speaker system itself has been turned off.

As the mains plug is used to disconnect the speaker system from the mains, connect the speaker system to an easily accessible AC outlet. Should you notice an abnormality in the speaker system, disconnect the mains plug from the AC outlet immediately.

### CAUTION

Risk of explosion if the battery is replaced by an incorrect type. Do not expose batteries or appliances with battery-installed to excessive heat, such as sunshine and fire.

### Do not place this product close to medical devices.

This product (including accessories) has magnet(s) which may interfere with pacemakers, programmable shunt valves for hydrocephalus treatment, or other medical devices. Do not place this product close to persons who use such medical devices. Consult your doctor before using this product if you use any such medical device.

### Indoor use only.

### Recommended cables

Properly shielded and grounded cables and connectors must be used for connection to host computers and/or peripherals.

### For the bar speaker

The nameplate is located on the bottom of the bar speaker.

This equipment has been tested and found to comply with the limits set out in the EMC regulation using a connection cable shorter than 3 meters.

### For customers in Europe

**Notice for customers: the following information is only applicable to equipment sold in countries applying EU directives and/or UK applying relevant statutory requirements**

This product has been manufactured by or on behalf of Sony Corporation.

EU and UK Importer: Sony Europe B.V.

Inquiries to the EU Importer or related to product compliance in Europe should be sent to the manufacturer's authorized representative, Sony Belgium, bijkantor van Sony Europe B.V., Davincilaan 7-D1, 1930 Zaventem, Belgium.

Inquiries to the UK Importer or related to product compliance in the UK should be sent to the manufacturer's authorized representative, Sony Europe B.V., The Heights, Brooklands, Weybridge, Surrey KT13 0XW, United Kingdom.



Hereby, Sony Corporation declares that this equipment is in compliance with Directive 2014/53/EU. The full text of the EU declaration of conformity is available at the following internet address: <https://compliance.sony.eu>

Hereby, Sony Corporation declares that this equipment is in compliance with the UK relevant statutory requirements. The full text of the declaration of conformity is available at the following internet address: <https://compliance.sony.co.uk>

This radio equipment is intended to be used with the approved version(s) of software that are indicated in the Declaration of Conformity. The software loaded on this radio equipment is verified to comply with the essential requirements of the Radio Equipment Regulations. The software version can be found by following procedure.

### 6 Hang the bar speaker on the screws.

Align the holes on the rear of the bar speaker with the screws, then hang the bar speaker on the two screws.

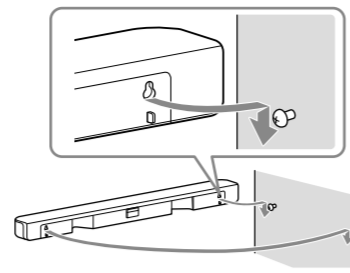

### Note

When sticking WALL MOUNT TEMPLATE, smooth it out fully.

## Connecting the Subwoofer Manually

If you cannot connect the subwoofer to the speaker system, or you use multiple wireless products and want to specify the wireless connection to link the speaker system to the subwoofer, perform the manual connection.

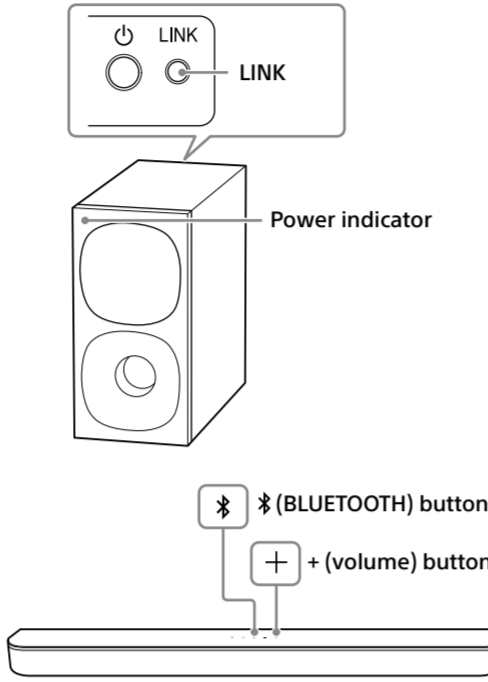

## Connecting a TV with an HDMI Cable and/or Optical Cable

Refer to Startup Guide (separate document).

## Mounting the Bar Speaker on a Wall

You can mount the bar speaker on a wall.

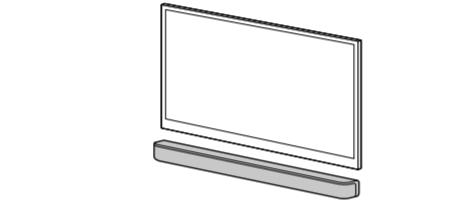

### Notes

- Prepare screws (not supplied) that are suitable for the wall material and strength. As a plasterboard wall is especially fragile, attach the screws securely in the wall beam. Install the bar speaker horizontally, hung by screws in studs in a continuous flat section of the wall.
- Have the installation done by a Sony dealer or licensed contractor and pay special attention to safety during the installation.
- If using a cable with a large plug, it may not be possible to mount the bar speaker on a wall.
- Sony shall not be held responsible for accidents or damage caused by improper installation, insufficient wall strength, improper screw installation, natural disasters, etc.

### 1 Prepare two screws (not supplied) that are suitable for the wall mount holes on the rear of the bar speaker.

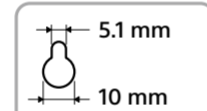
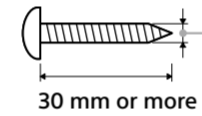

Hole on the rear of the bar speaker

### 2 Align the vertical line above the "TV CENTER LINE" printed on the WALL MOUNT TEMPLATE (supplied) with the center of the width of your TV.

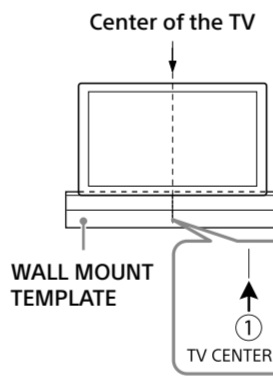

### 3 Align the "TV BOTTOM LINE" printed on the WALL MOUNT TEMPLATE with the bottom of your TV, then adhere the WALL MOUNT TEMPLATE on the wall with a commercially available adhesive tape, etc.

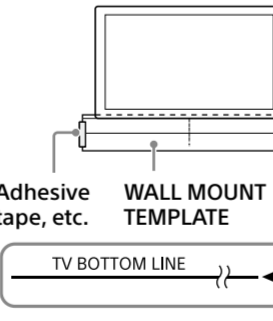

### 4 Fasten the screws prepared in step 1 securely into the screw marks (Ⓚ) on the "SCREW LINE" printed on the WALL MOUNT TEMPLATE.

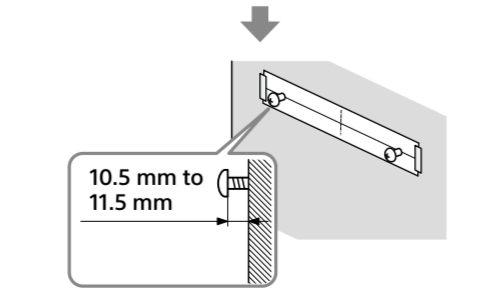
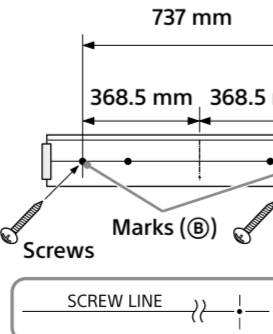

### 5 Remove the WALL MOUNT TEMPLATE.

## Subwoofer

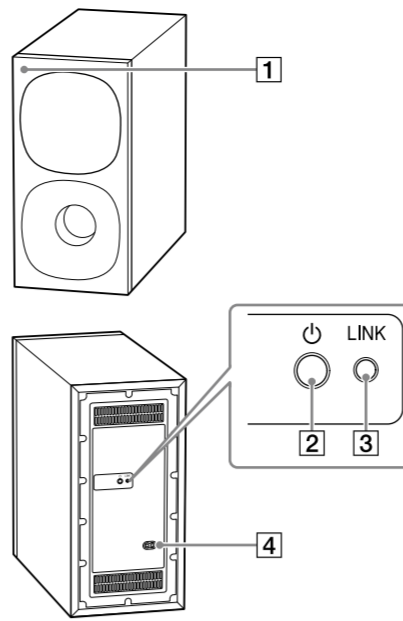

- Power indicator**
  - Lights in green: The subwoofer is connected to the speaker system.
  - Lights in red: The subwoofer is in standby mode.
  - Lights in amber: The subwoofer is connected to the speaker system with the manual connection.
  - Flashes slowly in green: The subwoofer is attempting to connect to the speaker system.
  - Flashes slowly in amber: The subwoofer is attempting to connect to the speaker system with the manual connection.
  - Flashes quickly in amber: The software is updating.
  - Turns off: The subwoofer is turned off.
- (power) button** Turns on or off the subwoofer.
- LINK button**
- AC inlet**

### Remote Control

Some buttons function differently depending on how long the button is pressed. This section explains the functions when pressed shortly. For details about other functions, refer to "Changing the Settings" on the back page.

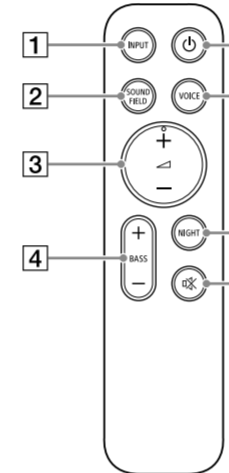

- INPUT** Selects the input for playback on the speaker system. Each time you press INPUT, the input source toggles between the TV and BLUETOOTH input.
- SOUND FIELD** Turns on/off the surround effect.
- (volume) +/-** Adjusts the volume.
- BASS +/-** Adjusts the subwoofer volume.
- (power) button** Turns on the speaker system or sets it to standby mode.
- VOICE** Turns on/off the voice mode.
- NIGHT** Turns on/off the night mode.
- (muting) button** Mutes the sound temporarily.

### About the replacement of batteries for the remote control

When the speaker system does not respond by operating with the remote control, replace two batteries with new batteries. Use R03 (size AAA) manganese batteries for replacement.

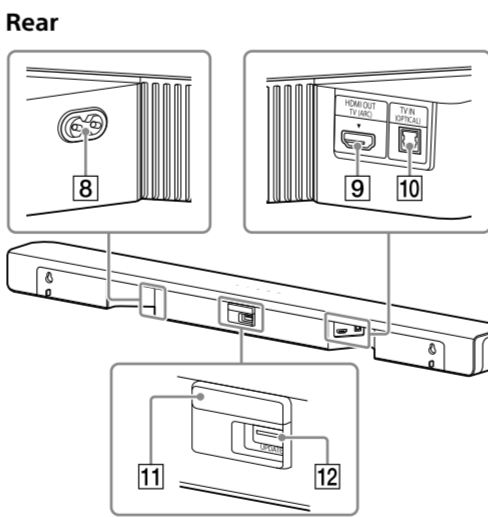

- AC inlet**
- HDMI OUT (TV (ARC)) jack** Connect a TV that has an HDMI input jack with an HDMI cable. The speaker system is compatible with Audio Return Channel (ARC). ARC is the function that sends TV sound to an AV device such as the speaker system from the TV's HDMI jack.
- TV IN (OPTICAL) jack**
- IR repeater** Transmits the remote signal of the TV remote control to the TV.
- UPDATE port** Connect the USB memory when updating the speaker system.

## Listening to Music/Sound

### Listening to a TV Connected with an HDMI Cable (ARC) or Optical Digital Cable

You can listen to TV sound on the speaker system.

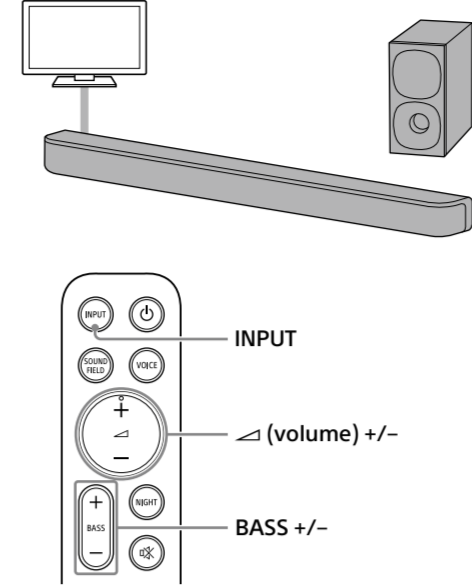

- Press **INPUT** repeatedly to select [TV] in the front panel display.
- Adjust the volume.
  - Adjust the volume by pressing (volume) +/- on the remote control.
  - Adjust the subwoofer volume by pressing BASS +/- on the remote control.

### Note

When you connect the TV to both the HDMI OUT (TV (ARC)) and TV IN (OPTICAL) jacks, the jack for audio input is selected depending on which audio signal is input first.

### Tip

You can also select the input by pressing (TV) on the bar speaker.

## Listening to Music from a Mobile Device with the BLUETOOTH® Function

You can listen to music stored on a mobile device such as a smartphone or tablet via wireless connection by connecting the speaker system and the mobile device with the BLUETOOTH function. When connecting to the mobile device with the BLUETOOTH function, you can perform operations simply through the speaker system without turning the TV on.

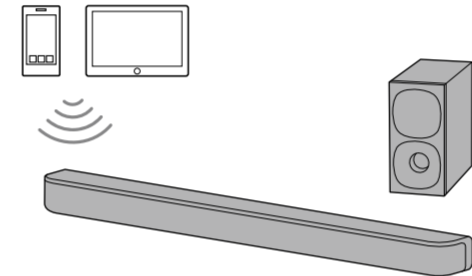

## Listening to Music by Pairing with a Mobile Device

You need to perform pairing of the speaker system and mobile device by using the BLUETOOTH function. Pairing is the process required to mutually register the information on BLUETOOTH devices to be connected wirelessly in advance.

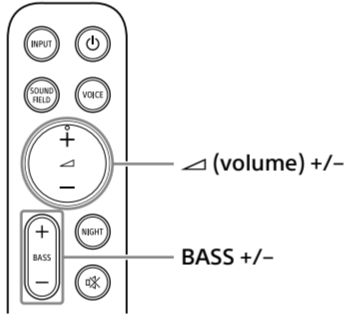

### 1 Press and hold (BLUETOOTH) on the bar speaker for 2 seconds.

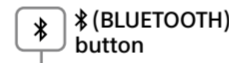

### 2 Make sure that the BLUETOOTH indicator on the bar speaker flashes twice repeatedly in blue and [PAIRING] appears in the front panel display. The speaker system enters the pairing mode.

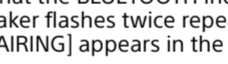

### 3 On the mobile device, search for the speaker system by performing the pairing operation. The list of the BLUETOOTH devices that are detected appears on the screen of the mobile device.

### 4 Pair the speaker system and mobile device by selecting "HT-S400" from the list on the screen of the mobile device.

If a passkey is requested, enter "0000."

### 5 Make sure that the BLUETOOTH indicator on the bar speaker lights in blue and [BT] appears in the front panel display. A connection between the speaker system and mobile device has been established.

### 6 Start audio playback with the music app on the connected mobile device. Sound is output from the speaker system.

### 7 Adjust the volume.

- Adjust the volume by pressing (volume) +/- on the remote control.
- Adjust the subwoofer volume by pressing BASS +/- on the remote control.

### Notes

- Your can pair up to 9 BLUETOOTH devices. If a 10th BLUETOOTH device is paired, the oldest connected device will be replaced by the new one.
- Perform pairing for the second and subsequent mobile devices.

### Tips

- You can check the connection status of the BLUETOOTH function by checking the BLUETOOTH indicator status.
- While the BLUETOOTH input is being selected, the speaker system enters the pairing mode by pressing (BLUETOOTH) on the bar speaker shortly.

## Listening to Music from the Paired Mobile Device

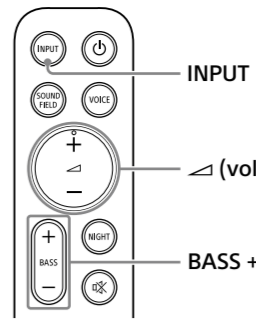

### 1 Turn the BLUETOOTH function of the mobile device on.

### 2 Press INPUT repeatedly to select [BT] or press (BLUETOOTH) on the bar speaker shortly. The BLUETOOTH indicator flashes and the speaker system automatically reconnects to the BLUETOOTH device it was most recently connected to.

### 3 Make sure that the BLUETOOTH indicator on the bar speaker lights in blue and [BT] appears in the front panel display. A connection between the speaker system and mobile device has been established.

### 4 Start audio playback with the music app on the connected mobile device. Sound is output from the speaker system.

### 5 Adjust the volume.

- Adjust the volume by pressing (volume) +/- on the remote control.
- Adjust the subwoofer volume by pressing BASS +/- on the remote control.

### Tip

If you select the BLUETOOTH input on the remote control supplied with the speaker system, the TV sound is not output from the speaker system. To output the TV sound, press INPUT on the remote control to change to the TV input.

## Listening to Sony TV Sound with the BLUETOOTH Function

When using Sony TV\* with the BLUETOOTH function, you can listen to sound of the TV or device that is connected to the TV by connecting the speaker system and TV wirelessly.

\* The TV needs to be compatible with A2DP (Advanced Audio Distribution Profile) of the BLUETOOTH profile.

### What You Can Do by Connecting a TV with the BLUETOOTH Function

When using Sony TV\* with the BLUETOOTH function, you can listen to sound of the TV or device that is connected to the TV by connecting the speaker system and TV wirelessly.

\* The TV needs to be compatible with A2DP (Advanced Audio Distribution Profile) of the BLUETOOTH profile.

Blue-ray Disc player, set-top box, gaming console, etc.

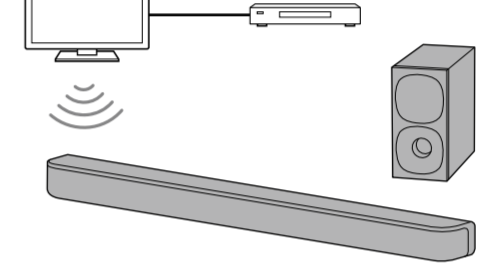

## Listening to TV Sound by Connecting the Speaker System and TV Wirelessly

You need to perform pairing of the speaker system and TV by using the BLUETOOTH function.

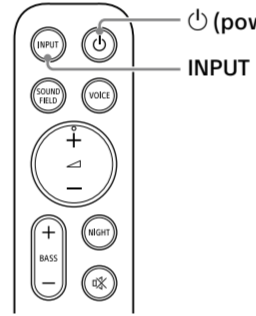

### 1 Turn on the TV.

### 2 Press (power) to turn on the speaker system.

### 3 Press and hold (BLUETOOTH) on the bar speaker and INPUT on the remote control simultaneously for 5 seconds. The speaker system enters the BLUETOOTH pairing mode. [TV-BT] and [ON] appears in order in the front panel display.

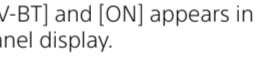

### 4 Make sure that the BLUETOOTH indicator on the bar speaker flashes twice repeatedly in blue and [PAIRING] appears in the front panel display.

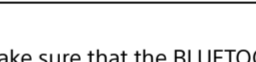

### 5 On the TV, search for the speaker system by performing the pairing operation. The list of the BLUETOOTH devices that are detected appears on the TV screen. For the operation method to pair the BLUETOOTH device to the TV, refer to the operating instructions of the TV.

### 6 Pair the speaker system and TV by selecting "HT-S400" from the list on the TV screen.

### 7 Make sure that the BLUETOOTH indicator on the bar speaker lights in blue and [TV-BT] appears in the front panel display. A connection between the speaker system and TV has been established.

### 8 Select the program or input of the device by using the TV remote control. The sound of the displayed image on the TV screen is output from the speaker system.

### 9 Adjust the volume of the speaker system by using the TV remote control. When pressing the muting button on the TV remote control, the sound is muted temporarily.

### Notes

- If the TV sound is not output from the speaker system, press INPUT to select the TV input and check the status of the front panel display and indicators on the bar speaker.
  - [TV-BT] appears in the front panel display. The speaker system and TV are connected, and TV sound is output from the speaker system.
  - The BLUETOOTH indicator flashes twice repeatedly and [PAIRING] appears in the front panel display. Perform pairing on the TV.
  - [TV] appears in the front panel display. Perform steps from the start.

### When you connect the speaker system and TV with an HDMI cable, the BLUETOOTH connection is canceled. To connect the speaker system and TV with the BLUETOOTH function again, disconnect the HDMI cable, then perform the connecting operation from the start.

## Listening to Sound of the Paired TV

### 1 Turn on the TV with the TV remote control. The speaker system is turned on by interlocking with the TV power and TV sound is output from the speaker system.

### 2 Select the program or input of the device by using the TV remote control. The sound of the displayed image on the TV screen is output from the speaker system.

### 3 Adjust the volume of the speaker system by using the TV remote control. When pressing the muting button on the TV remote control, the sound is muted temporarily.

### Tip

When the TV is turned off, the speaker system is also turned off by interlocking with the TV power.

### About operations with the remote control that is supplied with the speaker system

You can use the following buttons.

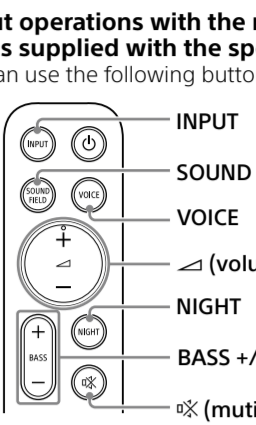

### Note

If you select the BLUETOOTH input on the remote control supplied with the speaker system, the TV sound is not output from the speaker system. To output the TV sound, press INPUT on the remote control to change to the TV input.

## Listening to Music from a Mobile Device with the BLUETOOTH® Function

You can listen to music stored on a mobile device such as a smartphone or tablet via wireless connection by connecting the speaker system and the mobile device with the BLUETOOTH function. When connecting to the mobile device with the BLUETOOTH function, you can perform operations simply through the speaker system without turning the TV on.

You need to perform pairing of the speaker system and mobile device by using the BLUETOOTH function. Pairing is the process required to mutually register the information on BLUETOOTH devices to be connected wirelessly in advance.

### About the replacement of batteries for the remote control

When the speaker system does not respond by operating with the remote control, replace two batteries with new batteries. Use R03 (size AAA) manganese batteries for replacement.

If a passkey is requested, enter "0000."

### Pair the speaker system and mobile device by selecting "HT-S400" from the list on the screen of the mobile device.

### Make sure that the BLUETOOTH indicator on the bar speaker lights in blue and [BT] appears in the front panel display. A connection between the speaker system and mobile device has been established.

### Start audio playback with the music app on the connected mobile device. Sound is output from the speaker system.

### Adjust the volume.

- Adjust the volume by pressing (volume) +/- on the remote control.
- Adjust the subwoofer volume by pressing BASS +/- on the remote control.

### Tip

If you select the BLUETOOTH input on the remote control supplied with the speaker system, the TV sound is not output from the speaker system. To output the TV sound, press INPUT on the remote control to change to the TV input.

## Listening to Music from a Mobile Device with the BLUETOOTH® Function

You can listen to music stored on a mobile device such as a smartphone or tablet via wireless connection by connecting the speaker system and the mobile device with the BLUETOOTH function. When connecting to the mobile device with the BLUETOOTH function, you can perform operations simply through the speaker system without turning the TV on.

You need to perform pairing of the speaker system and mobile device by using the BLUETOOTH function. Pairing is the process required to mutually register the information on BLUETOOTH devices to be connected wirelessly in advance.

### About the replacement of batteries for the remote control

When the speaker system does not respond by operating with the remote control, replace two batteries with new batteries. Use R03 (size AAA) manganese batteries for replacement.

### About the replacement of batteries for the remote control

When the speaker system does not respond by operating with the remote control, replace two batteries with new batteries. Use R03 (size AAA) manganese batteries for replacement.

### Pair the speaker system and mobile device by selecting "HT-S400" from the list on the screen of the mobile device.

### Make sure that the BLUETOOTH indicator on the bar speaker lights in blue and [BT] appears in the front panel display. A connection between the speaker system and mobile device has been established.

### Start audio playback with the music app on the connected mobile device. Sound is output from the speaker system.

### Adjust the volume.

- Adjust the volume by pressing (volume) +/- on the remote control.
- Adjust the subwoofer volume by pressing BASS +/- on the remote control.

### Tip

If you select the BLUETOOTH input on the remote control supplied with the speaker system, the TV sound is not output from the speaker system. To output the TV sound, press INPUT on the remote control to change to the TV input.

## Listening to Music from a Mobile Device with the BLUETOOTH® Function

You can listen to music stored on a mobile device such as a smartphone or tablet via wireless connection by connecting the speaker system and the mobile device with the BLUETOOTH function. When connecting to the mobile device with the BLUETOOTH function, you can perform operations simply through the speaker system without turning the TV on.

You need to perform pairing of the speaker system and mobile device by using the BLUETOOTH function. Pairing is the process required to mutually register the information on BLUETOOTH devices to be connected wirelessly in advance.

### About the replacement of batteries for the remote control

When the speaker system does not respond by operating with the remote control, replace two batteries with new batteries. Use R03 (size AAA) manganese batteries for replacement.

### Pair the speaker system and mobile device by selecting "HT-S400" from the list on the screen of the mobile device.

### Make sure that the BLUETOOTH

## Adjusting the Sound

## Enjoying Surround Effect (SOUND FIELD)

You can turn the surround effect on or off to suit sound sources.

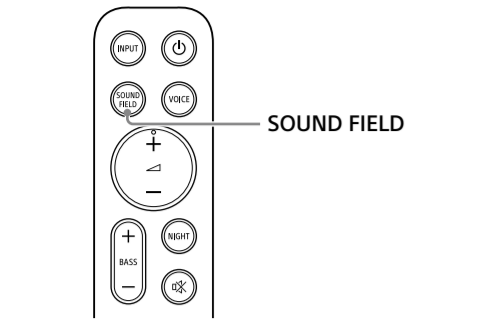

<b>1</b>	Press <b>SOUND FIELD</b> to select the setting. The setting appears in the front panel display.
Setting	Explanation
<b>[SF.ON]</b>	The sound is output with the surround effect. This setting is suitable for experiencing the surround sound with presence.
<b>[SF.OFF]</b>	The sound is output without the surround effect. This setting is suitable for listening to music or news.

## Making Dialogs Clearer (VOICE)

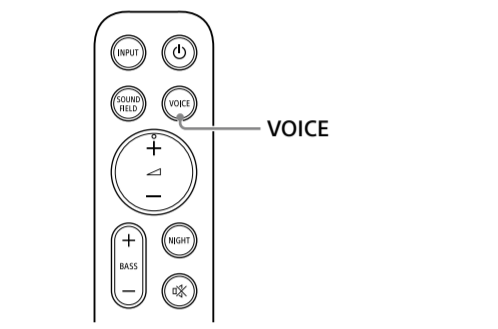

<b>1</b>	Press <b>VOICE</b> to select the setting. The setting appears in the front panel display.
Setting	Explanation
<b>[Vo.ON]</b>	Dialog is easily heard by enhancing dialog range.
<b>[Vo.OFF]</b>	Deactivates the voice mode function.

## Enjoying Clear Sound with Low Volume at Midnight (NIGHT)

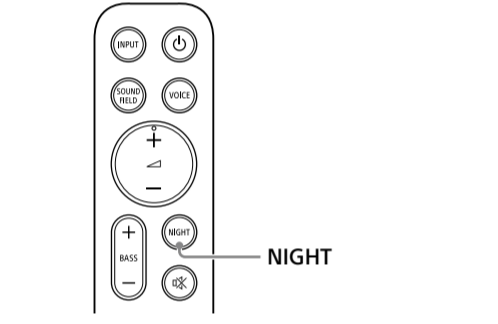

<b>1</b>	Press <b>NIGHT</b> to select the setting. The setting appears in the front panel display.
Setting	Explanation
<b>[N.ON]</b>	Sound is output at low volume with minimum loss of fidelity and clarity of dialog.
<b>[N.OFF]</b>	Deactivates the night mode function.

**Note**  
When you turn the speaker system off, this setting is set to [N.OFF] automatically.

## Using the Speaker System by Interlocking with a TV

## Operating the Speaker System by Interlocking with a TV (Control for HDMI Function)

Connecting a TV compatible with the Control for HDMI function using an HDMI cable enables you to interlock the speaker system operation such as power on/off or volume adjustment with a TV.

**About the Control for HDMI function**  
The Control for HDMI function is a function that enables operation of devices connected with an HDMI (High-Definition Multimedia Interface) cable by interlocking them. Although this function works for devices compatible with the Control for HDMI function, it may not work if connecting devices other than those manufactured by Sony.

### Preparing to Operate by Interlocking with a TV

Enable the Control for HDMI function settings of the TV connected to the speaker system with an HDMI cable.

The default setting of the Control for HDMI function of the speaker system is [ON].

**Tips**  
• When connecting a device such as a Blu-ray Disc player to a TV with an HDMI cable, enable its Control for HDMI function.  
• To enable the Control for HDMI function of a TV or Blu-ray Disc player, refer to their operating instructions.  
• If you enable the Control for HDMI ("BRAVIA" Sync) function when using a TV manufactured by Sony, the Control for HDMI function of the speaker system is also enabled automatically. When the setting is complete, [DONE] appears in the front panel display.

### Performing Power Operation or Volume Adjustment by a TV Remote Control

When turning the TV on/off or adjusting the volume using the TV remote control, the speaker system power operation or volume adjustment is interlocked.

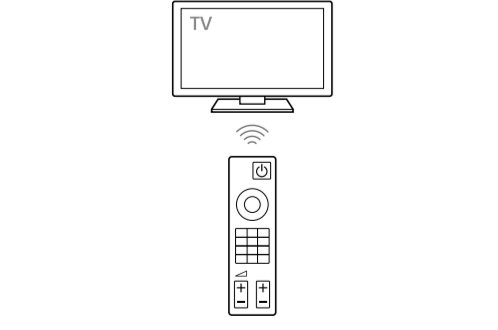

#### Power interlocking

When you turn on or off the TV, the speaker system will turn on or off automatically.

**Note**  
If you turn off the speaker system before turning off the TV, the speaker system may not turn on automatically even though you turn on the TV next time. In this case, perform the following operation.  
– Select the speaker system for the sound output device in the TV menu.  
– When using Sony TV, turn on the speaker system while the TV is turned on.

**Volume adjustment**  
The sound of the TV you are watching is output from the speaker system automatically. You can adjust the speaker system volume by the TV remote control.

**Tip**  
You can change the Control for HDMI settings by following procedure.

- Press and hold **VOICE** on the remote control for more than 5 seconds. [CONTROL FOR HDMI] appears in the front panel display.
- Press **↔** (volume) +/- on the remote control to display the desired setting in the front panel display.
- Wait until the displayed setting disappears from the front panel display. The setting is fixed.

## Operating the Speaker System by Interlocking with a TV Compatible with the "BRAVIA" Sync Function

"BRAVIA" Sync is an extended function developed by HDMI function on the Control for HDMI function. By connecting "BRAVIA" Sync-compatible devices such as a TV using an HDMI cable, you can control the devices by interlocking them with each other.

**To use "BRAVIA" Sync**  
"BRAVIA" Sync is enabled by enabling the Control for HDMI function of the Sony device. For the operation to enable the Control for HDMI function, see "Preparing to Operate by Interlocking with a TV."

#### What You Can Do with "BRAVIA" Sync

#### Control for HDMI function

- Power interlocking
- Volume adjustment

## Saving Power Consumption

To use the speaker system with saving power consumption, change the following settings.

## Turning the Speaker System Off by Detecting the Using State

When you set the auto standby function to on, the speaker system enters standby mode automatically when you do not operate the speaker system for about 20 minutes and the speaker system is not receiving an input signal.

- Press and hold **⏻** (power) and **□** (TV) on the bar speaker for more than 5 seconds. [AUTO STANDBY] and the current setting appear in the front panel display.
- Press **↔** (volume) +/- on the remote control to display the desired setting in the front panel display.
- Wait until the displayed setting disappears from the front panel display. The setting is fixed.

## Saving Power in Standby Mode

To save power consumption during the standby mode, set the BLUETOOTH standby mode and Control for HDMI function to off.

To change the BLUETOOTH standby mode setting, press and hold **⏻** (power), **⌘** (BLUETOOTH), and **↔** (volume) on the bar speaker for more than 5 seconds (the changed setting appears in the front panel display).

To change the Control for HDMI function setting, press and hold **VOICE** on the remote control for more than 5 seconds to display the setting in the front panel display, then press **↔** (volume) +/- on the remote control to select the desired setting.

## Changing the Settings

<b>Audio Settings</b>		
Easily listening to low volume sounds.	You can easily listen to low volume sounds by compressing the dynamic range (the range between maximum and minimum volume) of the sound signal by setting to [ON]. This function works only when playing Dolby Digital signal.	<ol style="list-style-type: none"><li>Press and hold <b>⏻</b> (power), <b>□</b> (TV), and <b>↔</b> (volume) on the bar speaker for more than 5 seconds. [DRC] and the current setting appear in the front panel display.</li> <li>To change the setting, perform the same operation as step 1. The setting is fixed after the changed setting appears in the front panel display.</li></ol>
Adjusting the volume of the connected device automatically	You can adjust the volume automatically depending on the input signal or contents of a connected device by setting to [ON].	<ol style="list-style-type: none"><li>Press and hold <b>NIGHT</b> on the remote control for more than 5 seconds. [A/VOL] appears in the front panel display.</li> <li>Press <b>↔</b> (volume) +/- on the remote control to display the desired setting in the front panel display.</li> <li>Wait until the displayed setting disappears from the front panel display. The setting is fixed.</li></ol>
Selecting the sound for multiplex broadcast	You can select the sound for multiplex broadcast.	<ol style="list-style-type: none"><li>Press and hold <b>⌘</b> (muting) on the remote control for more than 5 seconds. [DUAL] appears in the front panel display.</li> <li>Press <b>↔</b> (volume) +/- on the remote control to display the desired setting in the front panel display.</li> <li>Wait until the displayed setting disappears from the front panel display. The setting is fixed.</li></ol>

#### BLUETOOTH Settings

Turning the BLUETOOTH standby mode on or off	You can turn the speaker system on and start the BLUETOOTH connection automatically with the BLUETOOTH device operation while the speaker system is in standby mode by setting to [ON].	<ol style="list-style-type: none"><li>Press and hold <b>⏻</b> (power), <b>⌘</b> (BLUETOOTH), and <b>↔</b> (volume) on the remote control for more than 5 seconds. [BT STANDBY] and the current setting appear in the front panel display.</li> <li>To change the setting, perform the same operation as step 1. The setting is fixed after the changed setting appears in the front panel display.</li></ol>
--	---	--

**Notes**  
• While the BLUETOOTH standby mode is on, standby power consumption increases.  
• The BLUETOOTH standby mode cannot be set while the BLUETOOTH function is on.

Turning the BLUETOOTH function on or off	You can turn the BLUETOOTH function on or off.	<ol style="list-style-type: none"><li>Press and hold <b>⏻</b> (power) and <b>⌘</b> (BLUETOOTH) on the bar speaker for more than 5 seconds. [BT POWER] and the current setting appear in the front panel display.</li> <li>To change the setting, perform the same operation as step 1. The setting is fixed after the changed setting appears in the front panel display.</li></ol>
--	--	---

#### Front Panel Display/Indicators Settings

Adjusting the brightness of the front panel display and indicators	You can change the brightness of the followings. <ul style="list-style-type: none"><li>Front panel display on the bar speaker</li> <li>BLUETOOTH indicator on the bar speaker</li> <li>Power indicator on the subwoofer</li></ul>	<ol style="list-style-type: none"><li>Press and hold <b>□</b> (TV) and <b>⌘</b> (BLUETOOTH) on the bar speaker for more than 5 seconds. [DIMMER] appears in the front panel display.</li> <li>Press <b>↔</b> (volume) +/- on the remote control to display the desired setting in the front panel display.</li> <li>Wait until the displayed setting disappears from the front panel display. The setting is fixed.</li></ol>
--	---	---

Checking the sound settings and software version	You can check the stream information, current settings of the sound field and voice/night modes, and software version.	<ol style="list-style-type: none"><li>Press and hold <b>SOUND FIELD</b> on the remote control for more than 5 seconds. The stream information appears in the front panel display.</li> <li>Press <b>↔</b> (volume) +/- on the remote control to display the desired checking item. Each time you press <b>↔</b> (volume) – on the remote control, the displayed item changes cyclically as follows. Stream information → Sound field → Voice mode → Night mode → Software version The checking item appears in the reverse order by pressing <b>↔</b> (volume) +.</li></ol>
--	--	---

Using the IR repeater function	When the bar speaker obstructs the remote control sensor of the TV, the TV remote control may not work. In that case, enable the IR repeater function of the speaker system. You can control the TV with the TV remote control by sending the remote signal that the bar speaker received to the TV.	<ol style="list-style-type: none"><li>Press and hold <b>⌘</b> (BLUETOOTH) and <b>↔</b> (volume) on the bar speaker for more than 5 seconds. [IR REPEATER] appears in the front panel display.</li> <li>Press <b>↔</b> (volume) +/- on the remote control to display the desired setting in the front panel display.</li> <li>Wait until the displayed setting disappears from the front panel display. The setting is fixed.</li></ol>
--------------------------------	--	--

Updating the software	Start the software update after connecting the USB memory on which the software update file is stored to the bar speaker. For information about the software updates, visit the following website: <ul style="list-style-type: none"><li>For customers in Americas https://www.sony.com/am/support</li> <li>For customers in Europe https://www.sony.eu/support</li> <li>For customers in Asia-Pacific, Oceania, Middle East, and Africa https://www.sony-asia.com/support</li></ul>	<ol style="list-style-type: none"><li>Connect the <b>USB memory on which the software update file is stored to the UPDATE port</b> on the bar speaker.</li> <li>Press and hold <b>⏻</b> (power), <b>⌘</b> (BLUETOOTH), and <b>+</b> (volume) on the bar speaker for more than 5 seconds. [UPDATE] appears in the front panel display and the software update starts.</li></ol> <p><b>Note</b> Before updating, make sure the following. – The subwoofer function is on. – The subwoofer is turned on and connected to the speaker system.</p> <ul style="list-style-type: none"><li>Select the TV input by pressing INPUT.</li> <li>Increase the volume on the TV or cancel muting.</li> <li>Depending on the order in which you turn on the TV and the speaker system, the speaker system may be muted. If this happens, turn on the TV first, then the speaker system.</li> <li>Set the speakers setting of the TV (BRAVIA) to Audio System. Refer to the operating instructions of your TV regarding how to set the TV.</li></ul>
-----------------------	--	--

## Troubleshooting

## Troubleshooting

If the speaker system does not work properly, handle it in the following order.

- Search for the **cause and solution of the issue using this troubleshooting.**
- Reset the speaker system.** All the settings of the speaker system return to their initial status. For details, see "Resetting the Speaker System."

Should any problems persist, consult your nearest Sony dealer.

#### Power

**The speaker system does not power up.**  
• Check that the AC power cord (mains lead) is connected securely.  
• Disconnect the AC power cord (mains lead) from the wall outlet (mains), and then reconnect after several minutes.

**The speaker system is turned off automatically.**

- The auto standby function is working. Press and hold **⏻** (power) and **□** (TV) on the bar speaker for more than 5 seconds to display [AUTO STANDBY] in the front panel display, then press **↔** (volume) +/- on the remote control to display [OFF] in the front panel display.

**The speaker system does not turn on even when the TV is turned on.**

- Set the Control for HDMI function to on. Press and hold **VOICE** on the remote control for more than 5 seconds to display [CONTROL FOR HDMI] in the front panel display, then press **↔** (volume) +/- on the remote control to display [ON] in the front panel display. The TV must support the Control for HDMI function. For details, refer to the operating instructions of your TV.
- Check the speaker settings of the TV. The speaker system power syncs with the speaker settings of the TV. For details, refer to the operating instructions of your TV.

- Depending on the TV, if the sound was output from the speakers of the TV the previous time, the speaker system may not turn on by interlocking with the TV power even when the TV is turned on.

**The speaker system turns off when the TV is turned off.**

- Check the setting of the Control for HDMI function by pressing and holding **VOICE** on the remote control for more than 5 seconds to display [CONTROL FOR HDMI] in the front panel display. To change the setting, press **↔** (volume) +/- on the remote control. When the Control for HDMI function is set to on and the input of the speaker system is the TV input, the speaker system turns off automatically when you turn off the TV.

**The speaker system does not turn off even when the TV is turned off.**

- Check the setting of the Control for HDMI function by pressing and holding **VOICE** on the remote control for more than 5 seconds to display [CONTROL FOR HDMI] in the front panel display. To change the setting, press **↔** (volume) +/- on the remote control. When you turn off the TV, the speaker system turns off automatically only if the input of the speaker system is the TV input. The TV must support the Control for HDMI function. For details, refer to the operating instructions of your TV.

#### Picture

**There is no picture or the picture is not output correctly.**

- When there is no picture while TV input is selected, select the TV channel that you want using the TV remote control.

#### Sound

**The speaker system cannot connect to a TV with the BLUETOOTH function.**

- When you connect the speaker system and TV with an HDMI cable (not supplied), the BLUETOOTH connection is canceled. Disconnect the HDMI cable, then perform the connecting operation from the start.

**No TV sound is output from the speaker system.**

- Check the type and connection of the HDMI cable or optical digital cable that is connected to the speaker system and the TV (refer to the supplied Startup Guide).
- Disconnect the cables that are connected between the TV and the speaker system, then connect them firmly again. Disconnect the AC power cords of the TV and the speaker system from the AC outlets (mains), then connect them again.

- When the speaker system and TV are connected with an HDMI cable only, check the following.
  - The HDMI jack of the connected TV is labeled with "ARC."
  - The Control for HDMI function of the TV is set to on.

- On the speaker system, the Control for HDMI function is set to on. Press and hold **VOICE** on the remote control for more than 5 seconds to display [CONTROL FOR HDMI] in the front panel display, then press **↔** (volume) +/- on the remote control to display [ON] in the front panel display.

- If your TV is not compatible with ARC, connect the optical digital cable (supplied) (refer to the supplied Startup Guide). If the TV is not compatible with ARC, TV sound will not be output from the speaker system even if the speaker system is connected to the TV's HDMI IN jack.

- Check the TV input by pressing INPUT.
- Increase the volume on the TV or cancel muting.
- Depending on the order in which you turn on the TV and the speaker system, the speaker system may be muted. If this happens, turn on the TV first, then the speaker system.
- Set the speakers setting of the TV (BRAVIA) to Audio System. Refer to the operating instructions of your TV regarding how to set the TV.
- Check the sound output of the TV. Refer to the operating instructions of the TV for the TV settings.
- The speaker system supports the Dolby Digital and PCM audio formats. When you playback an unsupported format, set the digital audio output setting of the TV (BRAVIA) to "PCM." For details, refer to the operating instructions of your TV.

**The sound is output from both the speaker system and the TV.**

- Change the output setting of the TV so that the TV sound is output from the external speaker.

- Set the TV volume to minimum.

**The output sound of the speaker system is not the same level as that of the TV even though the values of the volume level on the speaker system and TV are set to the same value.**

- If the Control for HDMI function is set to on, the value of the volume level on the speaker system may appear on your TV as the TV volume. The output sound levels of the speaker system and TV differ even though the values of the volume level on the speaker system and TV are set to the same value. The output sound levels of the speaker system and TV differ depending on the sound processing characteristics of each, and it is not a malfunction.

**The surround effect cannot be obtained.**  
• Change the input signal and the sound field setting, surround sound processing may not work effectively. The surround effect may be subtle, depending on the program or disc.

- To play multi channel audio, check the digital audio output setting on the device connected to

the speaker system. For details, see the operating instructions of the connected device.

#### Subwoofer

**No sound or only very low-level sound is heard from the subwoofer.**

- Press **BASS +** on the remote control to increase the subwoofer volume.
- Make sure that the power indicator on the subwoofer is lit in green or amber.
- If the power indicator on the subwoofer does not light, try the following.
  - Make sure the AC power cord (mains lead) of the subwoofer is connected properly.
  - Press **⏻** (power) of the subwoofer to turn on the power.
  - If the power indicator on the subwoofer lights in red, try the following.
    - Move the subwoofer to a location near the bar speaker so that the power indicator on the subwoofer lights in green or amber.
    - Follow the steps in "Connecting the Subwoofer Manually."
  - If the power indicator on the subwoofer flashes in red, press **⏻** (power) of the subwoofer to turn off the power and check whether the ventilation holes of the subwoofer is blocked or not.
  - If the input sources contain very little bass sound components (i.e., a TV broadcast), the sound from the subwoofer may be difficult to hear. Play the built-in demonstration music by following the steps below and check that the sound is output from the subwoofer.
    - Press and hold **□** (TV) on the bar speaker for 5 seconds. The built-in demonstration music is played.
    - Press **□** (TV) again. The built-in demonstration music is canceled and the speaker system returns to TV input.
- Set the night mode to off by pressing **NIGHT**.

**BASS +/- does not work and [NOT USE] appears in the front panel display.**

- BASS +/- does not work when the subwoofer is not connected. Check the power and connection status of the subwoofer.

#### Mobile Device Connection

**BLUETOOTH connection cannot be completed.**

- Make sure that the BLUETOOTH indicator on the bar speaker is lit.
- Make sure the BLUETOOTH device to be connected is turned on and the BLUETOOTH function is enabled.
- Bring the BLUETOOTH device close to the bar speaker.
- Pair the speaker system and the BLUETOOTH device again. You may need to cancel the pairing with the speaker system using your BLUETOOTH device first.
- If the BLUETOOTH function is set to off, set it to on. To change the BLUETOOTH function setting, press and hold **⏻** (power) and **⌘** (BLUETOOTH) on the bar speaker for more than 5 seconds (the changed setting appears in the front panel display).

#### Pairing cannot be achieved.

- Bring the BLUETOOTH device close to the bar speaker.
- Make sure the speaker system is not receiving interference from a wireless LAN device, other 2.4 GHz wireless devices, or a microwave oven. If a device that generates electromagnetic radiation is nearby, move the device away from the speaker system.
- Pairing may not be possible if other BLUETOOTH devices are present around the speaker system. In this case, turn off the other BLUETOOTH devices.

**Sound of the connected BLUETOOTH mobile device is not output from the speaker system.**

- Make sure that the BLUETOOTH indicator on the bar speaker is lit.
- Bring the BLUETOOTH device close to the bar speaker.
- If a device that generates electromagnetic radiation, such as a wireless LAN device, other BLUETOOTH devices, or a microwave oven is nearby, move the device away from the speaker system.
- Remove any obstacle between the bar speaker and the BLUETOOTH device or move the bar speaker away from the obstacle.
- If the bar speaker is installed under the TV, move the bar speaker away from the TV.
- Reposition the connected BLUETOOTH device.
- Switch the wireless LAN frequency of any nearby wireless LAN router or PC to 5 GHz range.
- Increase the volume on the connected BLUETOOTH device.

**The sound is not in sync with the image.**

- When you are watching movies, you may hear the sound with a slight delay from the image.

#### Remote Control

**The remote control of the speaker system does not function.**

- Point the remote control at the remote control sensor on the bar speaker.
- Remove any obstacles in the path between the remote control and the speaker system.
- Replace both batteries in the remote control with new ones, if they are weak.
- Make sure you are pressing the correct button on the remote control.

**The TV remote control does not work.**  
– Install the bar speaker so that it does not obstruct the remote control sensor of the TV.

- This problem might be solved by enabling the IR repeater function. Press and hold **⌘** (BLUETOOTH) and **–** (volume) on the bar speaker for more than 5 seconds to display [IR REPEATER] in the front panel display, then press **↔** (volume) +/- on the remote control to display [ON] in the front panel display.

#### Others

**The Control for HDMI function does not work properly.**

- Check the connection with the speaker system (refer to the supplied Startup Guide).
- Enable the Control for HDMI function on the TV. For details, refer to the operating instructions of your TV.
- Wait a while, and then try again. If you unplug the speaker system, it will take a while before operation can be made. Wait for 15 seconds or longer, and then try again.
- Make sure the TV connected to the speaker system supports the Control for HDMI function.
- The type and number of devices that can be controlled by the Control for HDMI function is restricted by the HDMI CEC standard as follows:
  - Recording devices (Blu-ray Disc recorder, DVD recorder, etc.): up to 3 devices
  - Playback devices (Blu-ray Disc player, DVD player, etc.): up to 3 devices
  - Tuner-related devices: up to 4 devices
  - Audio system (receiver/headphone): up to 1 device (used by the speaker system)

**[PROTECT] is scrolled in the front panel display, then the speaker system is turned off after 5 seconds.**

- The protection feature is activated. Disconnect the AC power cord (mains lead) and make sure that the ventilations of the bar speaker are not covered and turn on the speaker system after a while.

**Sensors of the TV do not work properly.**

- The bar speaker may block some sensors (such as the brightness sensor), the remote control sensor of your TV or the emitter for 3D glasses (infrared transmission) of a 3D TV that supports the infrared 3D glass system, or wireless communication. Move the bar speaker away from the TV within a range that allows those parts to operate properly. For the locations of the sensors and remote control receiver, refer to the operating instructions of the TV.

**The speaker system does not work properly.**

- The speaker system may be in demo mode. To cancel demo mode, reset the speaker system. Press and hold **⏻** (power) and **–** [volume] on the bar speaker for more than 5 seconds.

#### The following message appears.

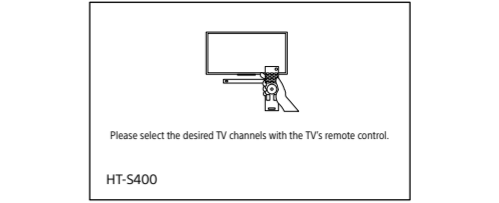

- This screen is an example for English.
- Select the TV program by using the TV remote control.

## Resetting the Speaker System

If the speaker system does not operate properly, reset the speaker system as follows.

- Press and hold **⏻** (power) and **–** (volume) on the bar speaker for more than 5 seconds. [RESET] appears in the front panel display, and the settings return to their initial status.
- Disconnect the **AC power cord (mains lead)**.
- Connect the **AC power cord (mains lead)**, then press **⏻** (power) to turn on the speaker system.

## Specifications

## Bar Speaker (SA-S400)

<b>Amplifier section</b>	
<b>POWER OUTPUT</b> (rated)	Front L + Front R: 60 W + 60 W (at 4 ohms, 1 kHz, 1% THD)
<b>CDP</b> (reference level)	Front L/Front R: speaker: 100 W (per channel at 4 ohms, 1 kHz)
<b>Input</b>	TV IN (OPTICAL)
<b>Output</b>	HDMI OUT (TV (ARC))
<b>HDMI section</b>	
<b>Connector</b>	Type A (19 pin)
<b>USB section</b>	
<b>UPDATE part:</b>	Type A (For software update only)
<b>BLUETOOTH section</b>	
<b>Communication system</b>	BLUETOOTH Specification version 5.0
<b>Output</b>	BLUETOOTH Specification Power Class 1
<b>Maximum communication range</b>	Line of sight approx. 25 m*
<b>Maximum number of devices to be registered</b>	Mobile device: 9 devices
<b>Sony TV device</b>	Maximum input power
<b>Frequency band</b>	2.4 GHz band (2,400 GHz - 2,4835 GHz)
<b>Modulation method</b>	FSK (Free Hopping Spread Spectrum)
<b>Compatible BLUETOOTH profiles<sup>1)</sup></b>	A2DP (Advanced Audio Distribution Profile)
<b>AVRCP (Audio Video Remote Control Profile) Supported Codes<sup>2)</sup></b>	"SC"
<b>Transmission range (A2DP)</b>	20 Hz - 20,000 Hz (Sampling frequency 32 kHz, 44.1 kHz, 48 kHz)