



LBP236dw / LBP233dw

User's Guide

Contents

Setting Up	2
Main Functions	3
Preparations Required Before Use	4
Preventing Unauthorized Access	5
Setting Up Using the Setup Guide	7
Setting the Date/Time	9
Setting Up the Network Environment	11
Selecting Wired LAN or Wireless LAN	13
Connecting to a Wired LAN	14
Connecting to a Wireless LAN	15
Setting Up Connection Using WPS Push Button Mode	17
Setting Up Connection Using WPS PIN Code Mode	19
Setting Up Connection by Selecting a Wireless Router	21
Setting Up Connection by Specifying Detailed Settings	23
Checking the SSID and Network Key	26
Setting IP Addresses	27
Setting IPv4 Address	28
Setting IPv6 Addresses	31
Viewing Network Settings	34
Configuring Settings for Communication with a Computer	36
Configuring Printing Protocols and WSD Functions	37
Configuring Printer Ports	40
Setting Up Print Server	43
Configuring the Machine for Your Network Environment	46
Configuring Ethernet Settings	47
Changing the Maximum Transmission Unit	49
Setting a Wait Time for Connecting to a Network	50
Configuring DNS	51
Configuring SMB	55
Configuring WINS	57
Monitoring and Controlling the Machine with SNMP	59
Other Network Settings	63
Installing Drivers	67
Basic Operations	70
Parts and Their Functions	73
Front Side	74
Back Side	76
Interior	77
Multi-Purpose Tray	78
Paper Drawer	79
Operation Panel	80
Turning ON the Machine	82

Turning OFF the Machine	83
Turning OFF the Machine by Remote Operation	84
Powering OFF at a Fixed Time	85
Restarting the Machine	87
Using the Operation Panel	89
Basic Screens	90
Home Screen	91
<Status Monitor> Screen	92
Message Display	94
Basic Operation	95
Entering Text	97
Logging in to the Machine	100
Loading Paper	101
Loading Paper in the Paper Drawer	103
Loading Paper in the Multi-Purpose Tray	108
Loading Envelopes	111
Loading Preprinted Paper	113
Specifying Paper Size and Type	117
Specifying Paper Size and Type in the Paper Drawer	118
Specifying Paper Size and Type in the Multi-Purpose Tray	120
Registering Default Paper Settings for the Multi-Purpose Tray	122
Registering a Custom Paper Size	124
Limiting the Paper Sizes Displayed	126
Automatically Selecting an Appropriate Paper Source for Each Function	127
Customizing the Display	128
Customizing the Home Screen	129
Setting Sounds	130
Entering Sleep Mode	131
Using a USB Memory Device	133

Printing 135

Printing from a Computer	136
Canceling Prints	138
Checking the Printing Status and Log	140
Various Printing Methods	142
Printing a Document Secured by a PIN (Secure Print)	143
Printing via Secure Print	144
Receiving I-Faxes for Printing	147

Linking with Mobile Devices 151

Connecting with Mobile Devices	152
Connecting via a Wireless LAN Router (LAN Connection)	153
Connecting Directly (Access Point Mode)	154
Utilizing the Machine through Applications	157
Using AirPrint	160

Printing with AirPrint	164
If AirPrint Cannot Be Used	167
Managing the Machine by the Remote Control	168

Managing the Machine 170

Setting Access Privileges	172
Setting the System Manager ID and PIN	173
Setting the Department ID Management	175
Setting a Remote UI PIN	181
Configuring the Network Security Settings	183
Restricting Communication by Using Firewalls	185
Specifying IP Addresses for Firewall Settings	186
Specifying MAC Addresses for Firewall Settings	189
Changing Port Numbers	192
Setting a Proxy	193
Configuring the Key and Certificate for TLS	195
Generating the Key and Certificate for Network Communication	199
Configuring the Expiration Check Method for Received Certificates	202
Generating a Key and Certificate Signing Request (CSR)	204
Registering the Key and Certificate for Network Communication	207
Configuring IPSec Settings	209
Configuring IEEE 802.1X Authentication Settings	216
Restricting the Machine's Functions	220
Restricting Printing from a Computer	222
Restricting USB Functions	223
Disabling HTTP Communication	224
Disabling Remote UI	225
Restricting Use of the Operation Panel	226
Managing the Machine from a Computer (Remote UI)	227
Starting Remote UI	228
Checking the Status and Logs	231
Setting Up Menu Options from Remote UI	237
Security Policy	240
Importing/Exporting the Setting Data	245
Updating the Firmware	248
Initializing Settings	251

Setting Menu List 254

<Preferences>	255
<Display Settings>	256
<English Keyboard Layout>	261
<Timer/Energy Settings>	262
<Network>	267
<External Interface>	281

<Accessibility>	282
<Volume Settings>	284
<Adjustment/Maintenance>	286
<Adjust Image Quality>	287
<Maintenance>	295
<Function Settings>	296
<Common>	297
<Printer>	300
<Receive>	325
<Secure Print>	327
<Management Settings>	328
<User Management>	329
<Device Management>	330
<Remote UI Settings/Update Firmware>	333
<Data Management>	335
<Security Settings>	337

Maintenance 340

Regular Cleaning	342
Cleaning the Exterior	343
Cleaning the Fixing Assembly	344
Replacing the Toner Cartridge	345
Checking the Remaining Amount of Consumables	352
Relocating the Machine	353
Adjusting Image Quality	355
Adjusting Print Density	356
Adjusting Print Position	357
Viewing the Counter Value	359
Printing Reports and Lists	360
Consumables	363

Troubleshooting (FAQ) 366

Appendix 368

Third Party Software	370
Feature Highlights	371
Going Green and Saving Money	372
Improving Efficiency	373
So Much More	374
Specifications	376
Main Unit	377
Available Paper	379
Cassette Feeding Module-AH	382
Printer Functions	383

Management Functions	385
System Environment	387
Network Environment	388
Options	389
Optional Equipment	390
Manuals and Their Contents	391
Using User's Guide	392
Screen Layout of User's Guide	393
Viewing User's Guide	396
Basic Windows Operations	398
Notice	405

Setting Up

Setting Up	2
Main Functions	3
Preparations Required Before Use	4
Preventing Unauthorized Access	5
Setting Up Using the Setup Guide	7
Setting the Date/Time	9
Setting Up the Network Environment	11
Selecting Wired LAN or Wireless LAN	13
Connecting to a Wired LAN	14
Connecting to a Wireless LAN	15
Setting Up Connection Using WPS Push Button Mode	17
Setting Up Connection Using WPS PIN Code Mode	19
Setting Up Connection by Selecting a Wireless Router	21
Setting Up Connection by Specifying Detailed Settings	23
Checking the SSID and Network Key	26
Setting IP Addresses	27
Setting IPv4 Address	28
Setting IPv6 Addresses	31
Viewing Network Settings	34
Configuring Settings for Communication with a Computer	36
Configuring Printing Protocols and WSD Functions	37
Configuring Printer Ports	40
Setting Up Print Server	43
Configuring the Machine for Your Network Environment	46
Configuring Ethernet Settings	47
Changing the Maximum Transmission Unit	49
Setting a Wait Time for Connecting to a Network	50
Configuring DNS	51
Configuring SMB	55
Configuring WINS	57
Monitoring and Controlling the Machine with SNMP	59
Other Network Settings	63
Installing Drivers	67

Setting Up

7YX2-006

Before using the functions of the machine, the environmental conditions must be set in advance. To begin with, check the sequences of flow required to complete the setup, and then perform the actual settings. **▶Preparations Required Before Use(P. 4)**

NOTE

- The functions installed on the machine vary depending on the model you purchased. Before using the machine, see **▶Main Functions(P. 3)** and check the available functions.

Configuring Initial Settings of the Machine (Setup Guide)

- You can easily configure the initial settings required to use the machine, such as date, time, and network settings, by following the on-screen guidance. **▶Setting Up Using the Setup Guide(P. 7)**

Main Functions

7YX2-007

This manual covers all the functions of the model series you purchased. Before getting started, check which functions are available on the model you purchased.

✓ : With function — : Without function

Function	LBP236dw	LBP233dw
Print	✓	✓
2-sided printing	✓	✓
Secure Print	✓	—
Wired LAN connection	✓	✓
Wireless LAN connection	✓	✓
USB connection	✓	✓
Remote UI	✓	✓
Keys and Certificates	✓	✓
Linking with Mobile Devices	✓	✓
Display	Black and white LCD	Black and white LCD
Default System Manager ID	Not specified	Not specified
Default System Manager PIN	Not specified	Not specified
Department ID Management	✓	✓
Cassette Feeding Module-AH	Optional	Optional

NOTE

- For the available driver types, see the User Software CD-ROM/DVD-ROM supplied with the machine, or see the Canon website (<https://global.canon/>).

LINKS

▶ [Viewing User's Guide\(P. 396\)](#)

Preparations Required Before Use

7YX2-008

Set up the machine following steps 1 to 3 in order. For more information about a particular step, click on the link to go to the corresponding section. In addition, to use the machine safely, also check **▶Preventing Unauthorized Access(P. 5)** .

Step 1

▶Setting Up Using the Setup Guide(P. 7)



Step 2

▶Setting Up the Network Environment(P. 11)

- Configure the network settings that are not covered in the Setup Guide. If you do not need to use the Setup Guide, configure the network settings from here.



Step 3

▶Installing Drivers(P. 67)



TIPS

Setting from the Remote UI

- When the network environment settings are complete, you can efficiently set the machine from a computer using Remote UI. **▶Starting Remote UI(P. 228)**

Importing data from another machine to save time

- As long as the model is the same, you can save setting data registered on another Canon printer/multifunction machine to a computer (export) and load the setting data to this machine (import). **▶Importing/Exporting the Setting Data(P. 245)**

Preventing Unauthorized Access

7YX2-009

This section describes the security measures on how to prevent unauthorized access from the external network. This is a must-read for all users and administrators before using this machine, other printers, and multifunction machines connected to the network. In recent years, a printer/multifunction machine connected to the network can offer you a variety of useful functions, such as printing from a computer, operating from a computer using the remote function, and sending scanned documents via the Internet. On the other hand, it is essential to take security measures to reduce the security risk for information leakage, as a printer/multifunction machine has become more exposed to threats, such as unauthorized access and theft, when it is connected to the network. This section explains necessary settings you need to specify to prevent unauthorized access before using a printer/multifunction machine connected to the network.

Security Measures to Prevent Unauthorized Access from the External Network

- ▶ **Assigning a Private IP Address(P. 5)**
- ▶ **Using Firewall to Restrict Transmission(P. 6)**
- ▶ **Specifying the TLS Encrypted Communication (P. 6)**
- ▶ **Setting PIN to Manage Information Stored in the Multifunction Machine(P. 6)**

Assigning a Private IP Address

An IP address is a numerical label assigned to each device participating in a computer network. A "global IP address" is used for the communication connecting to the Internet, and a "private IP address" is used for the communication within a local area network, such as a LAN in the company. If a global IP address is assigned, your printer/multifunction machine is open to the public and can be accessed via the Internet. Thus, the risk of information leakage due to unauthorized access from external network increases. On the other hand, if a private IP address is assigned, your printer/multifunction machine is closed to a local area network and can be accessed by only users on your local area network, such as a LAN in the company.

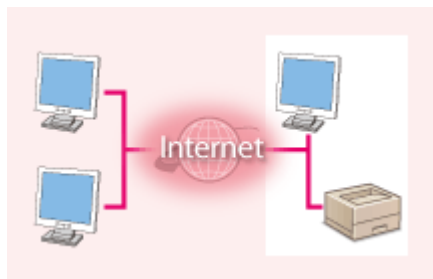

Global IP Address

Can be accessed from the external network

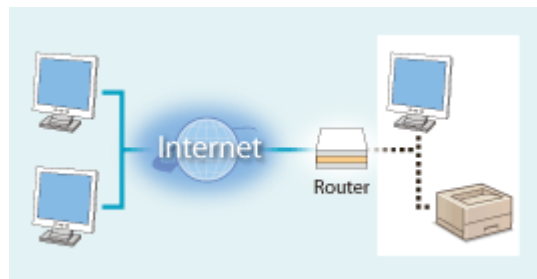

Private IP Address

Can be accessed from the users within a local area network

Basically, assign a private IP address to your printer/multifunction machine. Make sure to confirm the IP address, assigned to the printer/multifunction machine you are using, is a private IP address or not. A private IP address is found in one of the following ranges.

■ Ranges for Private IP addresses

- From 10.0.0.0 to 10.255.255.255
- From 172.16.0.0 to 172.31.255.255
- From 192.168.0.0 to 192.168.255.255

For information on how to confirm the IP address, see ▶ **Setting IPv4 Address(P. 28)** .

NOTE

- If a global IP address is assigned to a printer/multifunction machine, you can create a network environment to reduce the risk of unauthorized access by installing security software, such as a firewall that prevents

access from the external networks. If you want to assign a global IP address to and use a printer/multifunction machine, contact your network administrator.

Using Firewall to Restrict Transmission

A firewall is a system that prevents unauthorized access from the external networks and protects against attacks/intrusions to a local area network. You can use a firewall on your network environment to block access from the external network that appears to be dangerous, by restricting communication from specified IP address of the external network. The function installed to a Canon printer/multifunction machine enables you to set up the IP address filter. For information on how to set up an IP address filter, see [▶Specifying IP Addresses for Firewall Settings\(P. 186\)](#) .

Specifying the TLS Encrypted Communication

For information on the TLS Encrypted Communication, see [▶Configuring the Network Security Settings\(P. 183\)](#) , and on the procedures to specify, see [▶Configuring the Key and Certificate for TLS\(P. 195\)](#) .

Setting PIN to Manage Information Stored in the Multifunction Machine

If a malicious third party attempts to gain unauthorized access to a printer/multifunction machine, setting PIN to information stored in the machine will reduce the risk of information leakage. Canon printers/multifunction machines enable you to protect various type of information by setting PIN.

■Setting PIN to Each Function

- Setting PIN for Using Remote UI
For more information, see [▶Setting a Remote UI PIN\(P. 181\)](#) .
- Setting PIN for the System Manager Settings
For more information, see [▶Setting the System Manager ID and PIN\(P. 173\)](#) .

Listed above are some examples of security measures for preventing unauthorized access. For more information on the other security measures, see [▶Managing the Machine\(P. 170\)](#) and take necessary security measures for preventing unauthorized access to suit your environment.

Setting Up Using the Setup Guide

7YX2-00A

When the machine is turned on (**Turning ON the Machine(P. 82)**) for the first time, the Setup Guide starts up to assist you to configure the initial settings of the machine by following the on-screen guidance. In the Setup Guide, the setting screens are displayed in the following order.

Step 1

Setting the Display Language and the Country or Region

Set the language to be displayed on the operation panel screen or in reports, as well as the country or region where the machine will be used.

- 1 Select a language.
- 2 Select a country or region.

Step 2

Setting the Date and Time

Adjust the machine's date/time.

- 1 Select a time zone.

NOTE:

What is UTC?

- Coordinated Universal Time (UTC) is the primary time standard by which the world regulates clocks and time. The correct UTC time zone setting is required for Internet communications.

- 2 Enter the date and time, and press **OK**.
 - Use **◀** or **▶** to move the cursor, and enter the date and time using the numeric keys.

Step 3

Setting the Security

Specify the basic security settings to prevent unauthorized access to the machine.

- 1 Select <Yes> when using the Remote UI.
 - If you select <No>, the Remote UI settings are not configured, and the Setup Guide proceeds to step 4.
- 2 Press **OK**.
- 3 Select <Yes> when using General User mode.
 - If you select <No>, PIN is not set, and the Setup Guide proceeds to step 4.
 - You can also set the access security measure of the Remote UI later. **Setting a Remote UI PIN(P. 181)**
- 4 Enter a PIN, and press **OK**.
- 5 Enter the same PIN, and press **OK**.

Step 4

Setting the Wireless LAN

Configure the settings to connect to the network using the wireless LAN.

- 1 Select <Yes>.

Setting Up

- If you select <No>, wireless LAN is not set.
- 2** Select the network with a matching SSID.
 - 3** Enter the password (network key) and select <Apply>.
 - 4** Select <Yes>.
 - For more information about the wireless LAN settings, see **Connecting to a Wireless LAN(P. 15)** .

⇒ When the Setup Guide is complete, the Home screen appears.

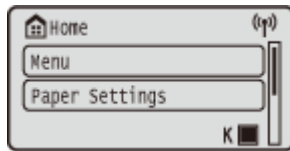

Setting the Date/Time

7YX2-00C

Set the date and time for the machine. The date and time are used as the reference for the functions specifying the time, therefore, they need to be set accurately.

- ▶ **Setting the Time Zone(P. 9)**
- ▶ **Setting the Current Date and Time(P. 9)**
- ▶ **Setting the Daylight Saving Time(P. 10)**

Setting the Time Zone

If the time zone setting is changed, the values set in <Current Date/Time Settings> are also changed accordingly.

- 1** Select <Menu> in the Home screen. ▶ **Home Screen(P. 91)**
- 2** Select <Preferences> ▶ <Timer/Energy Settings> ▶ <Date/Time Settings> ▶ <Time Zone>.
- 3** Select the time zone.



NOTE

What is UTC?

- Coordinated Universal Time (UTC) is the primary time standard by which the world regulates clocks and time. Time differences exist depending on the country or area where the machine is used. The correct UTC time zone setting is required for Internet communications.

Setting the Current Date and Time

- 1** Select <Menu> in the Home screen. ▶ **Home Screen(P. 91)**
- 2** Select <Preferences> ▶ <Timer/Energy Settings> ▶ <Current Date/Time Settings>.
- 3** Enter the date and time.
 - Use ◀ or ▶ to move the cursor, and enter the date and time using the numeric keys.

4 Press **OK**.

IMPORTANT

- Set <Time Zone> before setting the current date and time. If the <Time Zone> setting is changed later, the current date and time are also changed accordingly.

NOTE

- The display format of the date and time can be changed, respectively.
 - ▶ <Date Format>(P. 263)
 - ▶ <Time Format>(P. 263)

Setting the Daylight Saving Time

If daylight saving time is enabled, specify the dates from which and to which daylight saving time is in effect.

1 Select <Menu> in the Home screen. ▶ Home Screen(P. 91)

2 Select <Preferences> ▶ <Timer/Energy Settings> ▶ <Date/Time Settings> ▶ <Daylight Saving Time Settings>.

3 Select <Off> or <On> in <Daylight Saving Time>.

- When you select <On>, select <Start Date> and <End Date>, and set the month and day for each item. To set the day, specify "what day of which week."

4 Select <Apply>.

Setting Up the Network Environment

7YX2-00E

When connecting the machine to a wired or wireless local area network (LAN), you need to set an IP address unique to the selected network. Select "wired" or "wireless" depending on your communication environment and networking devices. For specific IP address settings, contact your Internet service provider or Network Administrator.

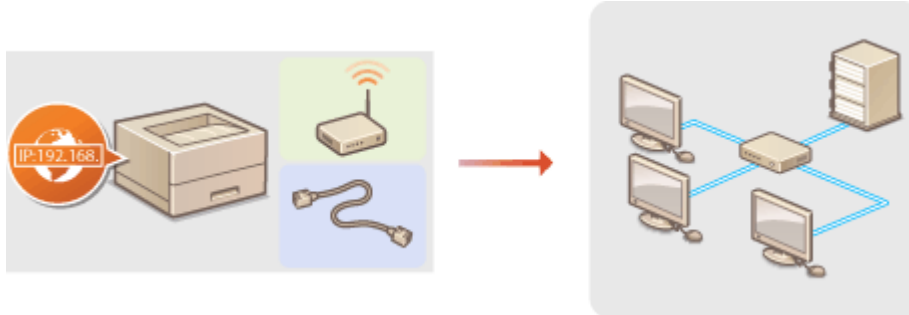

! IMPORTANT

- If the machine is connected to an unsecured network, your personal information might be leaked to a third party.

NOTE

- The machine cannot connect to both wired and wireless LANs at the same time.
- The machine does not come with a LAN cable or router. Have them ready as necessary.
- For more information about your networking devices, see the instruction manuals for the devices or contact your manufacturer.

■ Before You Start

Follow these steps to connect the machine to a network.



Check your computer settings.

- Make sure that the computer is correctly connected to the network. For more information, see the instruction manuals for the devices you are using, or contact the device manufacturers.
- Make sure that the network settings have been completed on the computer. If the network has not been set up properly, you will not be able to use the machine on the network, even if you perform the rest of the procedure below.

NOTE:

- Depending on the network, you may need to change settings for the communication method or the Ethernet type (▶ **Configuring Ethernet Settings(P. 47)**). For more information, contact your Internet service provider or Network Administrator.
- To check the MAC address of the machine.
 - ▶ **Viewing the MAC Address for Wired LAN(P. 34)**
 - ▶ **Viewing the MAC Address and Information for Wireless LAN(P. 35)**

- To connect to an IEEE 802.1X network, see [▶Configuring IEEE 802.1X Authentication Settings\(P. 216\)](#) .



2



Select wired or wireless LAN.

- ▶[Selecting Wired LAN or Wireless LAN\(P. 13\)](#)



3



Connect to a wired or wireless LAN.

- Proceed to the section that corresponds to the setting you selected in step 2.
 - ▶[Connecting to a Wired LAN\(P. 14\)](#)
 - ▶[Connecting to a Wireless LAN\(P. 15\)](#)



4



Set the IP address as necessary.

- At the time of purchase, the machine is set to automatically acquire an IP address. Change this setting if you want to use a specific IP address. ▶[Setting IP Addresses\(P. 27\)](#)



5



Confirm that proper connection is completed.

- Start the Remote UI from a computer (▶[Starting Remote UI\(P. 228\)](#)). If the Remote UI screen is displayed, the connection is completed.

LINKS



- ▶[Configuring Settings for Communication with a Computer\(P. 36\)](#)
- ▶[Configuring the Machine for Your Network Environment\(P. 46\)](#)

Selecting Wired LAN or Wireless LAN

7YX2-00F

After you decide on wired or wireless LAN to connect the machine to the computer, select wired LAN or wireless LAN using the operation panel. Note that if you change the setting from <Wired LAN> to <Wireless LAN> or vice versa, you will need to uninstall the drivers installed on your computer and then reinstall them. For more information, see the manuals for the relevant drivers on the online manual website.

- 1** Select <Menu> in the Home screen.  **Home Screen(P. 91)**

- 2** Select <Preferences>  <Network>.
 - If the login screen appears, enter the correct ID and PIN.  **Logging in to the Machine(P. 100)**

- 3** Select <Select Wired/Wireless LAN>.

- 4** Select <Wired LAN> or <Wireless LAN>.

LINKS

-  **Setting Up the Network Environment(P. 11)**
-  **Connecting to a Wired LAN(P. 14)**
-  **Connecting to a Wireless LAN(P. 15)**

Connecting to a Wired LAN

7YX2-00H

Connect the machine to a computer via a router. Use a LAN cable to connect the machine to the router.

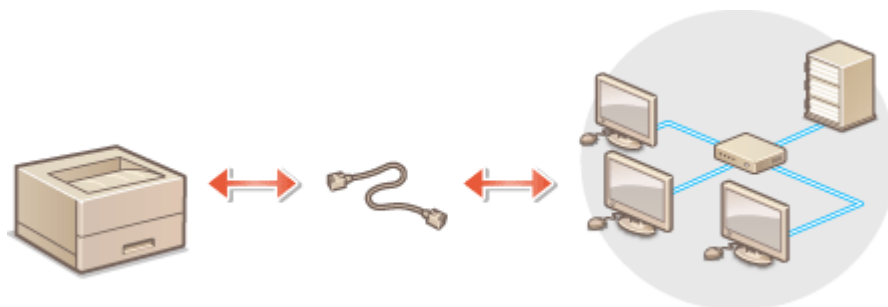

1 Connect a LAN cable.

- Connect the machine to a router by using a LAN cable.
- Push the connector in until it clicks into place.

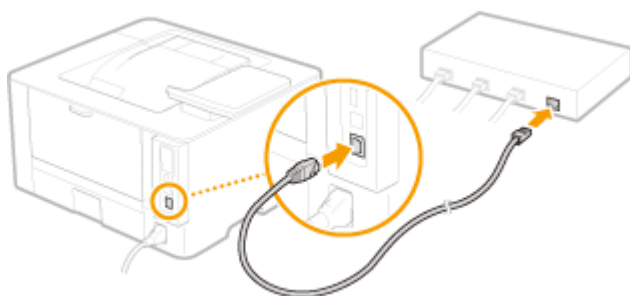

2 Wait for several minutes.

⇒ The IP address is set automatically.

NOTE:

- You can set the IP address manually. [▶Setting IP Addresses\(P. 27\)](#)

LINKS

[▶Setting Up the Network Environment\(P. 11\)](#)

Connecting to a Wireless LAN

7YX2-00J

Wireless routers (or access points) connect the machine to a computer via radio waves. If your wireless router is equipped with Wi-Fi Protected Setup (WPS), configuring your network is automatic and easy. If your networking devices do not support automatic configuration, or if you want to specify authentication and encryption settings in detail, you need to manually set up the connection. Make sure that your computer is correctly connected to the network.

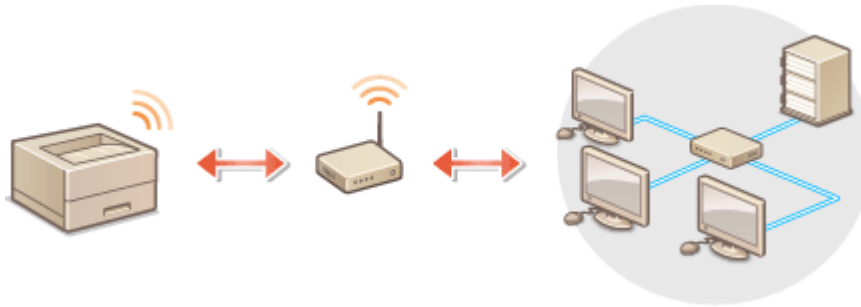

▶ **Setting Up Connection Using WPS(P. 15)**

▶ **Manually Setting Up Connection(P. 16)**

! IMPORTANT

Risk of information leak

- Use wireless LAN connection at your own discretion and at your own risk. If the machine is connected to an unsecured network, your personal information might be leaked to a third party because radio waves used in wireless communication can go anywhere nearby, even beyond walls.

Wireless LAN security

- The wireless LAN function of this machine supports WEP, WPA-PSK, and WPA2-PSK. For the wireless security compatibility of your wireless router, see the instruction manuals for your networking devices or contact your manufacturer.

NOTE

Required devices for wireless LAN connection

- The machine does not come with a wireless router. Have the router ready as necessary.

Setting Up Connection Using WPS

When using WPS, two modes are available: push button mode and PIN code mode.

■ Push Button Mode

Find the WPS mark shown below on the package of your wireless router. Also make sure that there is a WPS button on your networking device. ▶ **Setting Up Connection Using WPS Push Button Mode(P. 17)**



■ PIN Code Mode

Some WPS routers do not support the push button mode. If WPS PIN code mode is mentioned on the package or in the instruction manuals of your networking device, set up the connection by entering the PIN code. [▶Setting Up Connection Using WPS PIN Code Mode\(P. 19\)](#)

NOTE

- If the wireless router is set to use WEP authentication, you may not be able to set up connection using WPS.

Manually Setting Up Connection

When manually setting up a wireless connection, you can either select a wireless router or manually enter the required information. Regardless of the method, make sure that you have the required setup information, including the SSID and network key. [▶Checking the SSID and Network Key\(P. 26\)](#)

■ Selecting a Wireless Router

Select this setup option if you need to manually set up the connection but want to complete the setup as easily as possible. [▶Setting Up Connection by Selecting a Wireless Router\(P. 21\)](#)

■ Manually Entering the Setup Information

If you want to specify security settings in detail, such as authentication and encryption settings, manually enter the SSID and network key to set up the connection. [▶Setting Up Connection by Specifying Detailed Settings\(P. 23\)](#)

LINKS

[▶Setting Up the Network Environment\(P. 11\)](#)

[▶Selecting Wired LAN or Wireless LAN\(P. 13\)](#)

Setting Up Connection Using WPS Push Button Mode

7YX2-00K

If your wireless router supports WPS push button mode, you can easily set up a connection with a WPS button.

IMPORTANT

- How to operate the wireless router may vary on each device. See the instruction manuals for your networking device for help.

1 Select <Wireless LAN Set.> in the Home screen. Home Screen(P. 91)

- When a message appears on the display of the machine, select <Yes>.

NOTE:

- If a message is displayed telling that no access point can be found, select <Close>.

2 Select <Other Connections>.

3 Select <WPS Push Button Mode>.

4 Press and hold the WPS button on the wireless router.

- The button must be pressed within 2 minutes after selecting <WPS Push Button Mode> in step 3.
- Depending on the networking device, you may need to press and hold the button for 2 seconds or longer. See the instruction manuals for your networking device for help.

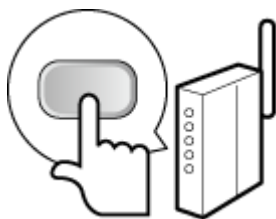

NOTE:

If an error message is displayed during setup

- Select <Close> and return to step 2.

5 Wait until message <Connected.> is displayed.

6 Select <Close>.

⇒ Wait several minutes until the IP address and other items are set automatically.

! IMPORTANT:**Signal strength**

- When more than one wireless router is available for connection, the machine connects to the device with the strongest signal. Signal strength is measured using RSSI (Received Signal Strength Indication).

NOTE:

- You can set the IP address manually. ▶ **Setting IP Addresses(P. 27)**
- While the machine is connected to the wireless LAN, the Wi-Fi icon is displayed in the Home screen or the Basic Features screen of each function. ▶ **Home Screen(P. 91)**

NOTE**Reducing power consumption**

- You can set the machine to enter <Power Save Mode> based on signals emitted from the wireless router. ▶ **<Power Save Mode>(P. 268)**

If the IP address of the machine has changed

- In a DHCP environment, the IP address of the machine may be changed automatically. If this happens, the connection is maintained as long as the machine and the computer belong to the same subnet.

LINKS

- ▶ **Connecting to a Wireless LAN(P. 15)**

Setting Up Connection Using WPS PIN Code Mode

7YX2-00L

If your wireless router supports WPS PIN code mode, generate a PIN code with the machine and register the code to the networking device.

IMPORTANT

- How to operate the wireless router may vary on each device. See the instruction manuals for your networking device for help.

From a Computer

1 Access your wireless router from a computer and display the screen for entering a WPS PIN code.

- For more information, see the instruction manuals for your networking device.

From the Operation Panel

2 Select <Wireless LAN Set.> in the Home screen. Home Screen(P. 91)

- When a message appears on the display of the machine, select <Yes>.

NOTE:

- If a message is displayed telling that no access point can be found, select <Close>.

3 Select <Other Connections>.

4 Select <WPS PIN Code Mode>.

⇒ The PIN code is generated and shown on the display.

From a Computer

5 Register the generated PIN code to the wireless router.

- Register the PIN code on the setup screen displayed in step 1.
- The PIN code must be registered within 10 minutes after selecting <WPS PIN Code Mode> in step 4.

NOTE:

If an error message is displayed during setup

- Select <Close> and return to step 3.



From the Operation Panel

6 Wait until the message **<Connected.>** is displayed.

7 Select **<Close>**.

⇒ Wait several minutes until the IP address and other items are set automatically.

IMPORTANT:

Signal strength

- When more than one wireless router is available for connection, the machine connects to the device with the strongest signal. Signal strength is measured using RSSI (Received Signal Strength Indication).

NOTE:

- You can set the IP address manually. ▶ **Setting IP Addresses(P. 27)**
- While the machine is connected to the wireless LAN, the Wi-Fi icon is displayed in the Home screen or the Basic Features screen of each function. ▶ **Home Screen(P. 91)**

NOTE

Reducing power consumption

- You can set the machine to enter **<Power Save Mode>** based on signals emitted from the wireless router. ▶ **<Power Save Mode>(P. 268)**

If the IP address of the machine has changed

- In a DHCP environment, the IP address of the machine may be changed automatically. If this happens, the connection is maintained as long as the machine and the computer belong to the same subnet.

LINKS

▶ **Connecting to a Wireless LAN(P. 15)**

Setting Up Connection by Selecting a Wireless Router

7YX2-00R

You can search the wireless routers (or access points) available for connection and select one from the display of the machine. For the network key, enter a WEP key or PSK. Before selecting a wireless router, check and write down the required setup information, including the SSID and network key ([▶Checking the SSID and Network Key\(P. 26\)](#)).

NOTE

Security settings

- If the wireless connection is set up by selecting a wireless router, the WEP authentication method is set to <Open System> or the WPA/WPA2 encryption method is set to <Auto> (AES-CCMP or TKIP). If you want to select <Shared Key> for WEP authentication or <AES-CCMP> for WPA/WPA2 encryption, you need to set up the connection using <Manually Enter Network Name>. [▶Setting Up Connection by Specifying Detailed Settings\(P. 23\)](#)

1 Select <Wireless LAN Set.> in the Home screen. [▶Home Screen\(P. 91\)](#)

- When a message appears on the display of the machine, select <Yes>.
 - ▣ The machine starts searching for available wireless routers.

NOTE:

- If a message is displayed telling that no access point can be found, check the network settings. For more information, see "Troubleshooting (FAQ)" on the online manual website.

2 Select a wireless LAN router.

- Select the router whose SSID matches the one that you have written down.

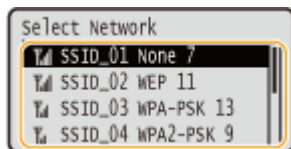

NOTE:

If your wireless router is not found

- Check whether the machine is properly installed and ready to connect to the network. For more information, see "Troubleshooting (FAQ)" on the online manual website.

3 Enter the network key that you have written down.

- Enter the network key, and select <Apply>.
- On how to enter text, see [▶Entering Text\(P. 97\)](#) .

NOTE:

If an error message is displayed during setup

- Select <Close>, check whether the network key is correct, and return to step 2.

4 Select <Yes>.

5 Wait until message <Connected.> is displayed.

6 Select <Close>.

▢ Wait several minutes until the IP address and other items are set automatically.

IMPORTANT:

Signal strength

- When more than one wireless router is available for connection, the machine connects to the device with the strongest signal. Signal strength is measured using RSSI (Received Signal Strength Indication).

NOTE:

- You can set the IP address manually. [▶Setting IP Addresses\(P. 27\)](#)
- While the machine is connected to the wireless LAN, the Wi-Fi icon is displayed in the Home screen or the Basic Features screen of each function. [▶Home Screen\(P. 91\)](#)

NOTE

Reducing power consumption

- You can set the machine to enter <Power Save Mode> based on signals emitted from the wireless router. [▶<Power Save Mode>\(P. 268\)](#)

If the IP address of the machine has changed

- In a DHCP environment, the IP address of the machine may be changed automatically. If this happens, the connection is maintained as long as the machine and the computer belong to the same subnet.

LINKS

[▶Connecting to a Wireless LAN\(P. 15\)](#)

Setting Up Connection by Specifying Detailed Settings

7YX2-00S

If you want to specify the security settings in detail or cannot establish the wireless connection using the other procedures, manually enter all the required information for the wireless LAN connection. Before specifying detailed settings, check and write down the required information, including the SSID, network key, and wireless security protocols. [▶Checking the SSID and Network Key\(P. 26\)](#)

1 Select <Wireless LAN Set.> in the Home screen. [▶Home Screen\(P. 91\)](#)

- When a message appears on the display of the machine, select <Yes>.

NOTE:

- If a message is displayed telling that no access point can be found, select <Close>.

2 Select <Other Connections>.

3 Select <Manually Enter Network Name>.

4 Enter the network name that you have written down, and select <Apply>.

- On how to enter text, see [▶Entering Text\(P. 97\)](#) .

5 Specify the security settings based on the information that you have written down.

- If you do not need to specify the security settings, select <None>.

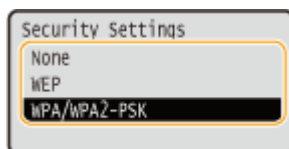

■Using WEP

- 1 Select <WEP>.
- 2 Select an authentication method.

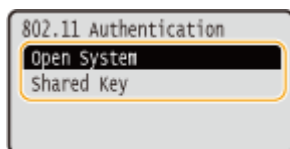

<Open System>

Sets open system authentication, which is also called "open authentication."

<Shared Key>

Uses the WEP key as a password.

NOTE:**When <Open System> is selected**

- When connecting to a wireless LAN, the machine experiences an authentication error if the shared key authentication is set on the wireless router. If this happens, the machine automatically changes the setting to <Shared Key> and retries the connection.
- 3 Select the WEP key you want to edit.
 - Select <Edit WEP Key> ► WEP key (1 to 4).
 - Up to four WEP keys can be registered.
 - 4 Enter the network key that you have written down.
 - Enter the network key, and select <Apply>.
 - 5 Select the desired WEP key.
 - Select <Select WEP Key> ► the WEP key you have edited.

■ Using WPA-PSK or WPA2-PSK

- 1 Select <WPA/WPA2-PSK>.
- 2 Select an encryption method.

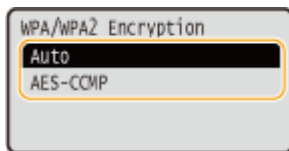
**<Auto>**

Sets the machine to automatically select AES-CCMP or TKIP to match the setting of the wireless router.

<AES-CCMP>

Sets AES-CCMP as the encryption method.

- 3 Enter the network key that you have written down.
 - Enter the network key, and select <Apply>.
- 6 Select <Yes>.
- 7 Wait until message <Connected.> is displayed.
- 8 Select <Close>.

⇒ Wait several minutes until the IP address and other items are set automatically.

! IMPORTANT:**Signal strength**

- When more than one wireless router is available for connection, the machine connects to the device with the strongest signal. Signal strength is measured using RSSI (Received Signal Strength Indication).

NOTE:

- You can set the IP address manually. ▶ **Setting IP Addresses(P. 27)**
- While the machine is connected to the wireless LAN, the Wi-Fi icon is displayed in the Home screen or the Basic Features screen of each function. ▶ **Home Screen(P. 91)**

NOTE

Reducing power consumption

- You can set the machine to enter <Power Save Mode> based on signals emitted from the wireless router. ▶ **<Power Save Mode>(P. 268)**

If the IP address of the machine has changed

- In a DHCP environment, the IP address of the machine may be changed automatically. If this happens, the connection is maintained as long as the machine and the computer belong to the same subnet.

LINKS

- ▶ **Connecting to a Wireless LAN(P. 15)**

Checking the SSID and Network Key

7YX2-00U

When manually setting up a wireless connection, you need to specify the SSID and network key of your wireless router. The SSID and network key may be indicated on these networking devices. Check your devices and write down the necessary information before setting up the connection. For more information, see the instruction manuals for your networking devices or contact your manufacturer.

SSID	A name given for identifying a specific wireless LAN. Some other terms used for SSID include "access point name" and "network name."
Network Key	A keyword or password used for encrypting data or authenticating a network. Some other terms used for network key include "encryption key," "WEP key," "WPA/WPA2 passphrase," and "preshared key (PSK)."
Wireless Security Protocols (Authentication/Encryption)	When manually setting up a wireless connection by specifying detailed settings, you need to specify security settings. Check the following information: <ul style="list-style-type: none"> • Security types (WEP/WPA-PSK/WPA2-PSK) • Authentication method (Open System/Shared Key) • Encryption method (TKIP/AES-CCMP)

■ Checking the SSID and Network Key from a Computer

The SSID or the network key may have been changed. If you do not know the SSID or the network key, you can check them by using the "Canon MF/LBP Wireless Setup Assistant." Download the "Canon MF/LBP Wireless Setup Assistant" from the Canon website (<https://global.canon/>), and start it up from a computer connected to a wireless LAN.

NOTE

- If no access point is displayed on the screen after startup of the "Canon MF/LBP Wireless Setup Assistant," check if the setup is completed both on the computer and the wireless LAN router.

LINKS

- ▶ **Connecting to a Wireless LAN(P. 15)**
- ▶ **Setting Up Connection by Selecting a Wireless Router(P. 21)**
- ▶ **Setting Up Connection by Specifying Detailed Settings(P. 23)**

Setting IP Addresses

7YX2-00W

Connecting the machine to a network requires a unique network IP address. Two versions of IP addresses are available: IPv4 and IPv6. Configure these settings depending on the network environment. To use IPv6 addresses, you need to properly configure the IPv4 address settings.

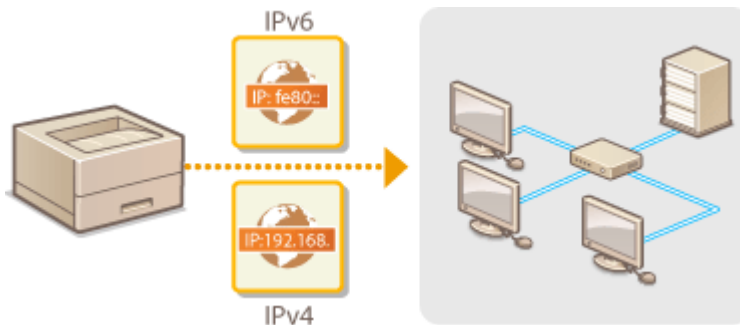

- ▶ [Setting IPv4 Address\(P. 28\)](#)
- ▶ [Setting IPv6 Addresses\(P. 31\)](#)

Setting IPv4 Address

7YX2-00X



The machine's IPv4 address can be either assigned automatically by a dynamic IP addressing protocol, such as DHCP, or entered manually. When connecting the machine to a wired LAN, make sure that the connectors of the LAN cable are firmly inserted into the ports (**▶Connecting to a Wired LAN(P. 14)**). You can test the network connection if necessary.

- ▶Setting IPv4 Address(P. 28)
- ▶Testing the Network Connection(P. 29)

Setting IPv4 Address

- 1** Select <Menu> in the Home screen. ▶Home Screen(P. 91)
- 2** Select <Preferences> ▶ <Network>.
 - If the login screen appears, enter the correct ID and PIN. ▶Logging in to the Machine(P. 100)
- 3** Select <TCP/IP Settings> ▶ <IPv4 Settings> ▶ <IP Address Settings>.
- 4** Configure IP address settings.

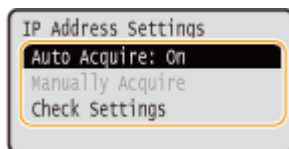

<Auto Acquire>

Select to automatically assign an IP address via DHCP protocol. When <On> is displayed, automatic addressing is enabled.

<Manually Acquire>

Select to configure the IP address settings by manually entering an IP address. In order to select this option, the automatic acquirement must be set to <Off>.

<Check Settings>

Select when you want to view the current IP address settings.

■Automatically assigning an IP address

- 1** Select <Auto Acquire>.
- 2** Select the protocol.
 - Select <Select Protocol> ▶ <DHCP>.

NOTE:

If you do not want to use DHCP/BOOTP/RARP to assign an IP address

- Select <Off>. If you select <DHCP> when these services are unavailable, the machine will waste time and communications resources searching the network for these services.
- 3** Check that <Auto IP> is set to <On>.
 - If <Off> is selected, change the setting to <On>.
 - 4** Select <Apply>.

NOTE:

- IP addresses assigned via DHCP override the address obtained via Auto IP.

Manually entering an IP address

- 1** Configure a setting to disable auto-acquisition.
 - Select <Auto Acquire>, and set both <Select Protocol> and <Auto IP> to <Off>.
- 2** Select <Manually Acquire>.
- 3** Specify the IP address, subnet mask, and gateway address (or default gateway).
 - Enter these values in each screen using the numeric keys, and press **OK**.

5 Restart the machine. ▶ Restarting the Machine(P. 87)**NOTE****Checking whether the settings are correct**

- Make sure that the Remote UI screen can be displayed with your computer (▶ **Starting Remote UI(P. 228)**). If a computer is not available, you can check the connection by using the operation panel (▶ **Testing the Network Connection(P. 29)**).

When you have changed the IP address after installing the printer driver

- You need to add a new port. ▶ **Configuring Printer Ports(P. 40)**

Testing the Network Connection

- 1** Select <Menu> in the Home screen. ▶ **Home Screen(P. 91)**
- 2** Select <Preferences> ▶ <Network>.
 - If the login screen appears, enter the correct ID and PIN. ▶ **Logging in to the Machine(P. 100)**
- 3** Select <TCP/IP Settings> ▶ <IPv4 Settings> ▶ <PING Command>.
- 4** Enter the IPv4 address of another device on the network, and press **OK**.

▢ If a proper connection has been established, <Received response from the host.> is displayed.

LINKS

- ▶ **Setting IPv6 Addresses(P. 31)**
- ▶ **Viewing Network Settings(P. 34)**
- ▶ **Configuring WINS(P. 57)**

Setting IPv6 Addresses

7YX2-00Y



The IPv6 addresses of the machine can be configured via the Remote UI. Before setting IPv6 addresses, check the IPv4 address settings ([▶Viewing IPv4 Settings\(P. 34\)](#)). You need to set the correct IPv4 settings to use IPv6 addresses. The machine can use the following multiple IPv6 addresses:

Type	Description
Link-local address	An address that is only valid within a subnet or link and cannot be used to communicate with devices beyond a router. A link-local address is automatically set when the IPv6 function of the machine is enabled.
Manual address	An address that is entered manually. When using this address, specify the prefix length and default router address.
Stateless address	An address that is generated automatically using the MAC address of the machine and the network prefix that is advertised by the router. Stateless addresses are discarded when the machine is restarted (or turned ON).
Stateful address	An address obtained from a DHCP server using DHCPv6.

NOTE

- For more information about the basic operations to be performed when setting the machine from the Remote UI, see [▶Setting Up Menu Options from Remote UI\(P. 237\)](#) .

- 1 Start the Remote UI and log in to System Manager Mode. [▶Starting Remote UI\(P. 228\)](#)**
- 2 Click [Settings/Registration] on the Portal page. [▶Remote UI Screen\(P. 229\)](#)**
- 3 Select [Network Settings] ▶ [IPv6 Settings].**
- 4 Click [Edit].**
- 5 Select the [Use IPv6] check box and configure the required settings.**

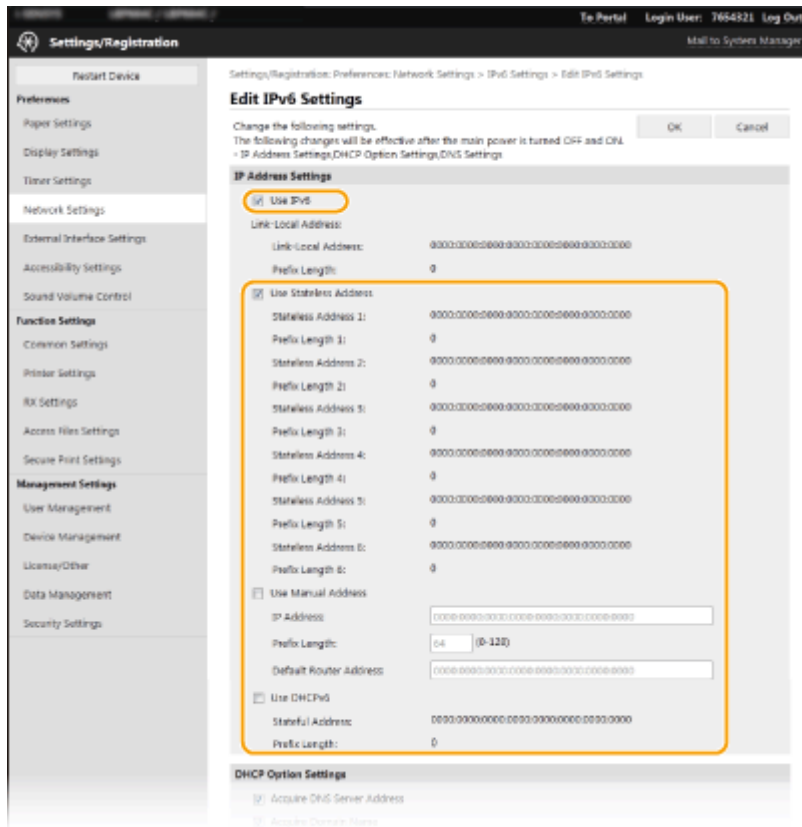
**[Use IPv6]**

Select the check box to enable IPv6 on the machine. When not using IPv6, clear the check box.

[Stateless Address 1]

Select the check box when using a stateless address. When not using a stateless address, clear the check box.

[Use Manual Address]

When you want to manually enter an IPv6 address, select the check box and enter the IP address, prefix length, and default router address in the corresponding text boxes.

[IP Address]

Enter an IPv6 address. Addresses that start with "ff" (or multicast address) cannot be entered.

[Prefix Length]

Enter a number that indicates how many bits are available for the network address.

[Default Router Address]

Specify the IPv6 address of the default router as necessary. Addresses that start with "ff" (or multicast address) cannot be entered.

[Use DHCPv6]

Select the check box when using a stateful address. When not using DHCPv6, clear the check box.

6 Click [OK].**7 Restart the machine. ▶ Restarting the Machine(P. 87)****NOTE****Checking whether the settings are correct**

- Make sure that the Remote UI screen can be displayed with your computer by using the IPv6 address of the machine. ▶ Starting Remote UI(P. 228)

Selecting settings from the operation panel

- IPv6 settings can also be accessed from <Menu> in the Home screen. [▶<IPv6 Settings>\(P. 272\)](#)

When you have changed the IP address after installing the printer driver

- You need to add a new port. [▶Configuring Printer Ports\(P. 40\)](#)

LINKS

[▶Setting IPv4 Address\(P. 28\)](#)

[▶Viewing Network Settings\(P. 34\)](#)

Viewing Network Settings

7YX2-010

- ▶ **Viewing IPv4 Settings(P. 34)**
- ▶ **Viewing IPv6 Settings(P. 34)**
- ▶ **Viewing the MAC Address for Wired LAN(P. 34)**
- ▶ **Viewing the MAC Address and Information for Wireless LAN(P. 35)**

NOTE

- The IP address is not correctly configured if it is displayed as "0.0.0.0".
- Connecting the machine to a switching hub or bridge may result in a connection failure even when the IP address is correctly configured. This problem can be solved by setting a certain interval before the machine starts communicating. ▶ **Setting a Wait Time for Connecting to a Network(P. 50)**
- You can print a list of the current network settings. ▶ **User Data List/System Manager Data List(P. 360)**

Viewing IPv4 Settings



▶ <Network Information> ▶ <IPv4> ▶ Select the setting to view ▶ Check the settings

Viewing IPv6 Settings



▶ <Network Information> ▶ <IPv6> ▶ Select the setting to view ▶ Check the settings

Viewing the MAC Address for Wired LAN

1 Select <Menu> in the Home screen. ▶ **Home Screen(P. 91)**

2 Select <Preferences> ▶ <Network>.

- If the login screen appears, enter the correct ID and PIN. ▶ **Logging in to the Machine(P. 100)**

3 Select <Ethernet Driver Settings>.

⇒ The MAC address is displayed.

Viewing the MAC Address and Information for Wireless LAN

1 Select <Wireless LAN Set.> in the Home screen. Home Screen(P. 91)

- When a message appears on the display of the machine, select <Yes>.

NOTE:

- If a message is displayed telling that no access point can be found, select <Close>.

2 Select <Connection Settings>.

3 Select <Connection Information>.

4 Select the setting to view.

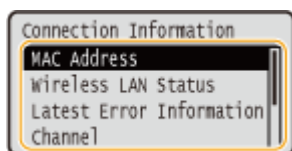



NOTE:





Viewing security information

- To view WEP and WPA/WPA2-PSK information, use the following procedure.
<Security Settings> ▶ Select the displayed security protocol ▶ Select the setting to view

Viewing from the <Status Monitor> screen

- <Wireless LAN Status> and <Latest Error Information> can be viewed from .
 ▶ <Network Information> ▶ <Network Connection Method> ▶ <Connection Information> ▶ Select the setting to view

LINKS

-  [Connecting to a Wireless LAN\(P. 15\)](#)
-  [Setting IPv4 Address\(P. 28\)](#)
-  [Setting IPv6 Addresses\(P. 31\)](#)
-  [Configuring DNS\(P. 51\)](#)

Configuring Settings for Communication with a Computer

7YX2-011

Specify the protocol and port when operating the machine from a computer via the network. Before configuring the machine for printing from a computer, perform the basic setup procedures. For more information, see the manuals for the relevant drivers on the online manual website.

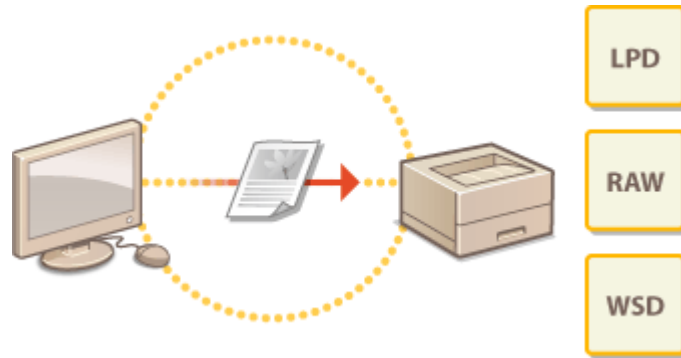

- ▶ [Configuring Printing Protocols and WSD Functions\(P. 37\)](#)
- ▶ [Configuring Printer Ports\(P. 40\)](#)
- ▶ [Setting Up Print Server\(P. 43\)](#)

NOTE

- Protocols explained here are rules for delivering document data between a computer and the machine, and can be selected according to intended purposes or the network environment.
- Ports are gateways for passing data between network devices. If a communication failure occurs in the network connection, the port settings may be the cause of the problem.

Configuring Printing Protocols and WSD Functions

7YX2-012

Configure the protocols that are used for printing documents from a networked computer.

NOTE

- For more information about the basic operations to be performed when setting the machine from the Remote UI, see [▶Setting Up Menu Options from Remote UI\(P. 237\)](#) .

- 1 Start the Remote UI and log in to System Manager Mode.** [▶Starting Remote UI\(P. 228\)](#)
- 2 Click [Settings/Registration] on the Portal page.** [▶Remote UI Screen\(P. 229\)](#)
- 3 Click [Network Settings].**
- 4 Configure printing protocols.**

■Configuring LPD or RAW

- 1** Select [LPD Settings] or [RAW Settings] ▶ [Edit].
- 2** Configure the settings as necessary.

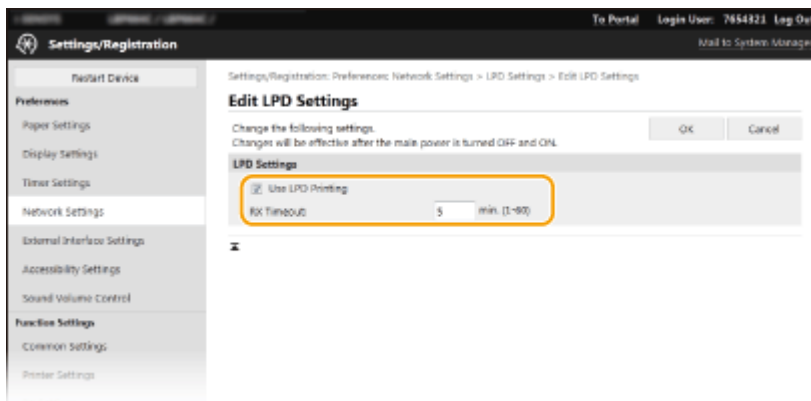

[Use LPD Printing]

Select the check box to print via LPD. When not using LPD printing, clear the check box.

[Use RAW Printing]

Select the check box to print via RAW. When not using RAW printing, clear the check box.

[RX Timeout]

Set a value as the restart wait time for data reception. If data reception does not resume within the set time, printing is canceled.

- 3** Click [OK].

■ Configuring WSD

- 1 Select [WSD Settings] ► [Edit].
- 2 Configure the settings as necessary.

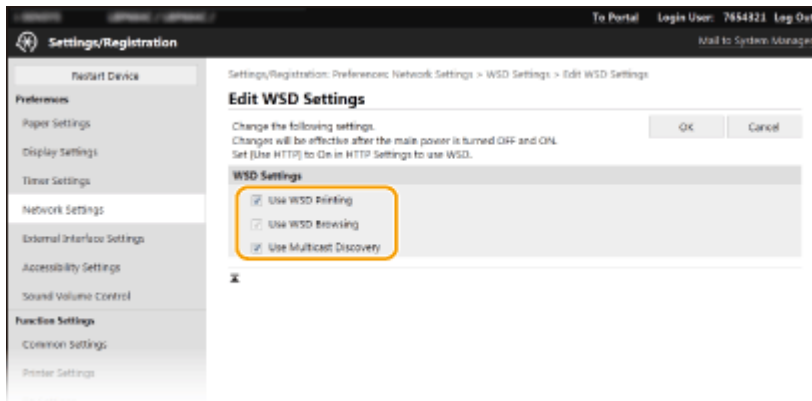

[Use WSD Printing]

Select the check box to print via WSD. When not using WSD printing, clear the check box.

[Use WSD Browsing]

Select the check box to obtain information about the machine from a computer via WSD. This check box is automatically selected when the [Use WSD Printing] check box is selected.

[Use Multicast Discovery]

Select the check box to set the machine to reply to multicast discovery messages. If the check box is cleared, the machine stays in sleep mode even when multicast discovery messages are flowing on the network.

- 3 Click [OK].

5 Restart the machine. ► Restarting the Machine(P. 87)

NOTE

Selecting settings from the operation panel

- LPD, RAW, and WSD settings can also be accessed from <Menu> in the Home screen.
 - <LPD Settings>(P. 274)
 - <RAW Settings>(P. 274)
 - <WSD Settings>(P. 274)

Setting up WSD network devices

- The WSD network devices can be added from the printer folder. Open the printer folder (► **Displaying the Printer Folder(P. 398)**) ► click [Add a device] or [Add a printer] and follow the on-screen instructions. For more information about how to install the driver for the WSD network, see the manuals for the relevant drivers on the online manual website.

To change the port number

- The same port number used for the machine and a computer must be used for printing protocol.
 - **Configuring Printer Ports(P. 40)**
 - **Changing Port Numbers(P. 192)**

LINKS

▶ **Configuring Printer Ports(P. 40)**

Configuring Printer Ports

7YX2-013

Printing errors can occur when the IP address of the machine has been changed, or when a printer has been added via the Windows printer folder. These errors are typically caused by incorrect printer port settings. For example, an incorrect port number or port type may have been specified. In such situations, your attempt to print fails because the document data cannot reach the machine. To fix this type of problem, configure the printer port settings on the computer.

! IMPORTANT

- To perform the following procedure, log in to your computer with an administrator account.

- 1 Open the printer folder. ▶ **Displaying the Printer Folder(P. 398)**
- 2 Right-click the driver icon for this machine, and click [Printer properties] or [Properties].
- 3 Click the [Ports] tab and configure the required settings.

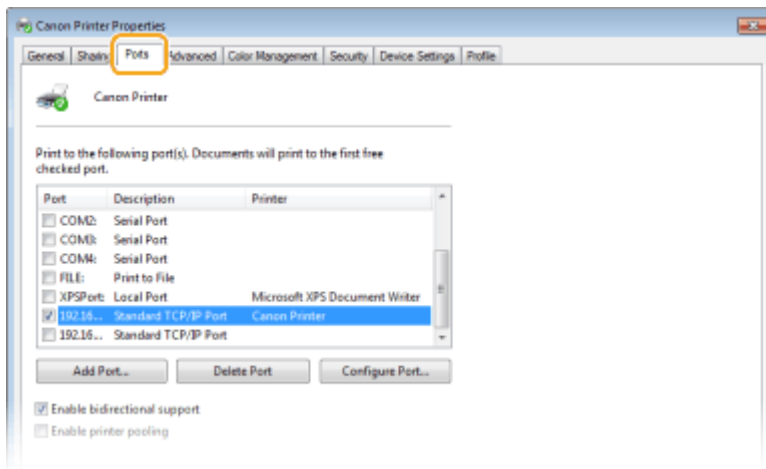

■ Adding a port

If you have changed the IP address of the machine or you have selected an incorrect port while installing drivers, add a new port.

- 1 Click [Add Port].
- 2 Select [Standard TCP/IP Port] in [Available port types] and click [New Port].
- 3 Click [Next].
- 4 Enter the IP address or the DNS name of the machine, and click [Next].
 - The [Port Name] is entered automatically. If necessary, you can change it.

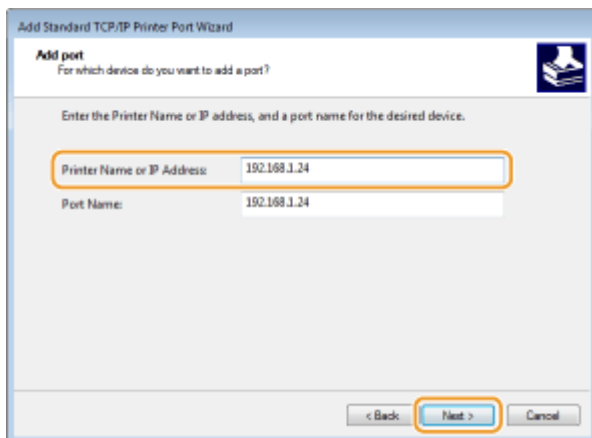

NOTE:

- When the next screen is displayed, follow the instructions on the screen.

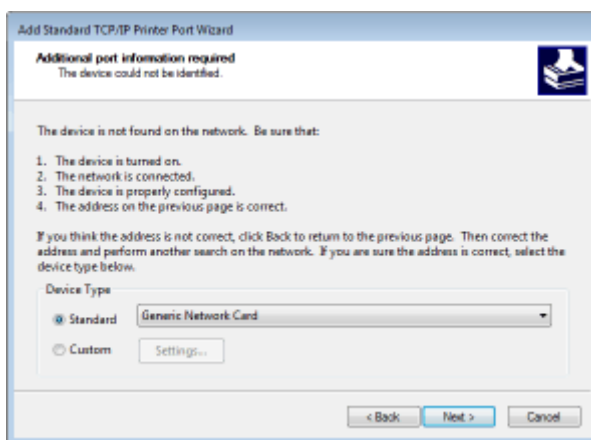

*When you select the [Device Type], select [Canon Network Printing Device with P9100] under [Standard].

- 5 Click [Finish].
- 6 Click [Close].

■ Changing the port type or number

If the printing protocol (LPD or RAW) has been changed on the machine side ([▶Configuring Printing Protocols and WSD Functions\(P. 37\)](#)) or the port number has been changed ([▶Changing Port Numbers\(P. 192\)](#)), the corresponding settings on the computer must also be configured. This operation is not needed for WSD ports.

- 1 Click [Configure Port].
- 2 Under [Protocol], select [Raw] or [LPR].
 - If you selected [Raw], change the [Port Number].
 - If you selected [LPR], enter "lp" in [Queue Name].
- 3 Click [OK].

■ Deleting ports

- 1 Select the port you want to delete, and click [Delete Port].

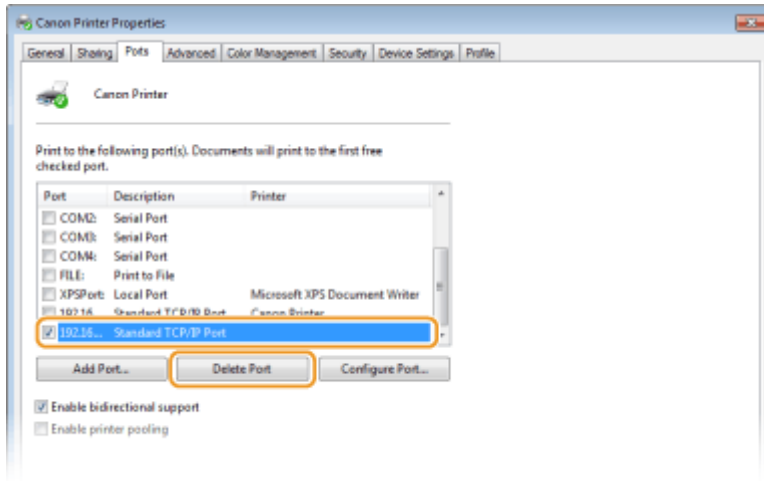

NOTE:

- You cannot delete a port currently configured as the printer port. To delete this port, select a different port and click [Apply] to configure it as the new printer port, and then delete the original port.

2 Click [OK].

4 Click [Close].

LINKS

🔗 **Setting Up Print Server(P. 43)**

Setting Up Print Server

7YX2-014

With a print server, you can reduce the load on the computer that you print from. The print server also makes it possible to install the drivers on each computer over the network, which saves you the trouble of installing the drivers on each computer by using the provided CD-ROM/DVD-ROM. To set up a computer on the network as a print server, configure the settings for sharing the printer.

! IMPORTANT

- To perform the following procedure, log in to your computer with an administrator account.
- You may be unable to install drivers over the network depending on the operating system and the bit architecture (32-bit or 64-bit) of the print server and client computers.
- When implementing a print server in a domain environment, consult your Network Administrator.

NOTE

To carry out Department ID Management when using a print server

- "Canon Driver Information Assist Service" must be added during the printer driver installation. For more information, see the manuals for the relevant drivers on the online manual website.

1 Open the printer folder. ▶ **Displaying the Printer Folder(P. 398)**

2 Right-click the printer driver icon for this machine and click [Printer properties] or [Properties].

3 Click the [Sharing] tab, select [Share this printer], and enter the share name of the machine.

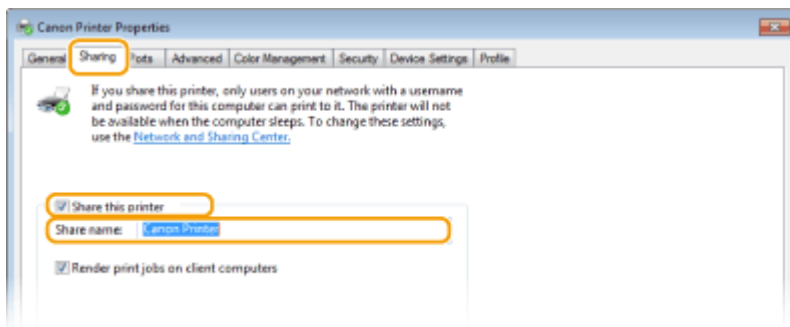

NOTE:

- Click the [Change Sharing Options] button if displayed.

4 Install additional drivers as necessary.

- This operation is required if you want to install the drivers in other computers running a different bit architecture via the print server.

- 1 Click [Additional Drivers].
- 2 Select the check box for the bit architecture that other computers are running, and click [OK].

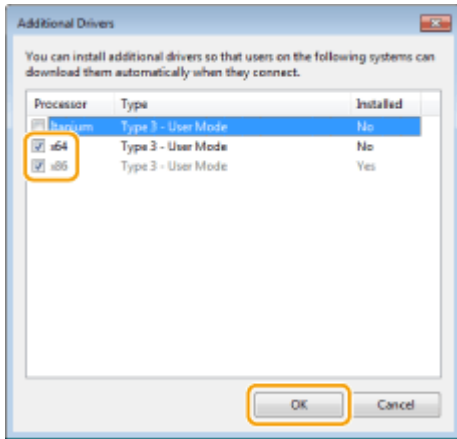

- Select additional drivers from the following, according to the operating system of the print server.

Print server	Select the check box for
32-bit operating systems	[x64]
64-bit operating systems	[x86] under [Processor]

NOTE:

- If you do not know whether your Windows operating system is a 32-bit or 64-bit version, see [▶ Checking the Bit Architecture\(P. 400\)](#) .
- 3 Insert the provided CD-ROM/DVD-ROM into the drive on the computer, click [Browse] to specify the folder that contains the drivers, and then click [OK].
 - If the print server runs a 32-bit operating system, select [UFRII] ▶ [uk_eng] ▶ [x64] ▶ [Driver] folders on the provided CD-ROM/DVD-ROM.
 - If the print server runs a 64-bit operating system, select [UFRII] ▶ [uk_eng] ▶ [32BIT] ▶ [Driver] folders on the provided CD-ROM/DVD-ROM.
 - 4 Follow the on-screen instructions to install additional drivers.

5 Click [OK].

■ Installing the Drivers on a Computer via the Print Server

- 1 **Locate the shared printer in the print server. ▶ Displaying Shared Printers in the Print Server(P. 399)**
- 2 **Double-click the shared printer.**

3 Follow the on-screen instructions to install the drivers.

LINKS

▶ **Printing from a Computer(P. 136)**

Configuring the Machine for Your Network Environment

7YX2-015

The configuration of a network varies depending on the purpose of the network. The machine has been designed to be compatible with as many network configurations as possible, and it is equipped with a variety of technologies. Consult your Network Administrator and set a configuration to suit your network environment.

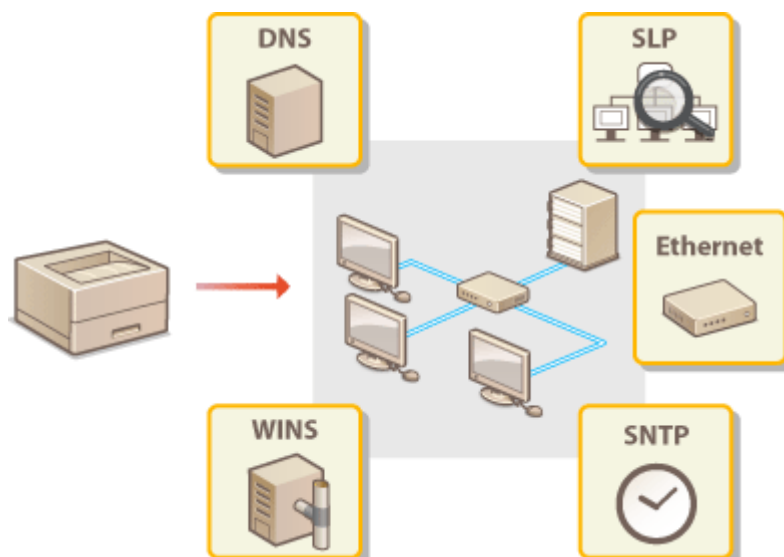

- ▶ **Configuring Ethernet Settings(P. 47)**
- ▶ **Changing the Maximum Transmission Unit(P. 49)**
- ▶ **Setting a Wait Time for Connecting to a Network(P. 50)**
- ▶ **Configuring DNS(P. 51)**
- ▶ **Configuring SMB(P. 55)**
- ▶ **Configuring WINS(P. 57)**
- ▶ **Monitoring and Controlling the Machine with SNMP(P. 59)**
- ▶ **Other Network Settings(P. 63)**

Configuring Ethernet Settings

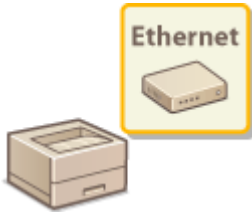

Ethernet is a standard for communicating data in a local area network (LAN). You can set the communication mode and the Ethernet type. In general, the machine can be used without changing the defaults (▶Ethernet Driver Settings(P. 278)), but you can change these settings to suit your network environment.

1 Select <Menu> in the Home screen. ▶Home Screen(P. 91)

2 Select <Preferences> ▶ <Network>.

- If the login screen appears, enter the correct ID and PIN. ▶Logging in to the Machine(P. 100)

3 Select <Ethernet Driver Settings>.

4 Select whether to configure Ethernet settings automatically or manually.

- If auto-detection is enabled, the machine detects and automatically sets the Ethernet communication mode and the type that can be used.

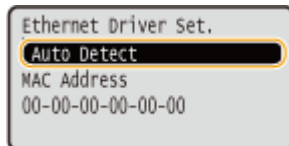

■ Configuring Ethernet settings automatically

Select <Auto Detect> ▶ <On>.

■ Configuring Ethernet settings manually

1 Select <Auto Detect> ▶ <Off>.

2 <Communication Mode> ▶ select the communication mode.

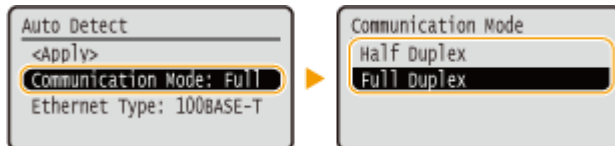

<Half Duplex>

Alternately sends and receives communication data. Select when the machine is connected to a networking device using half duplex.

<Full Duplex>

Simultaneously sends and receives communication data. Use this setting for most environments.

3 <Ethernet Type> ▶ select the Ethernet type.

4 Select <Apply>.

5 Restart the machine. ▶ **Restarting the Machine(P. 87)**

LINKS

▶ **Changing the Maximum Transmission Unit(P. 49)**

▶ **Setting a Wait Time for Connecting to a Network(P. 50)**

Changing the Maximum Transmission Unit

7YX2-017

In most Ethernet networks, the maximum size of a packet that can be sent is 1500 bytes. A packet refers to a chunk of data into which the original data is divided before being sent. The maximum transmission unit (MTU) may vary on each network. Change the settings of the machine as necessary. For more information, contact your Network Administrator.

1 Select <Menu> in the Home screen. [▶Home Screen\(P. 91\)](#)

2 Select <Preferences> ▶ <Network>.

- If the login screen appears, enter the correct ID and PIN. [▶Logging in to the Machine\(P. 100\)](#)

3 Select <TCP/IP Settings> ▶ <MTU Size>.

4 Select the MTU.

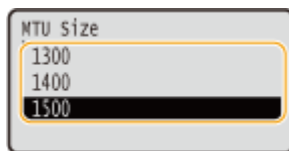

5 Restart the machine. [▶Restarting the Machine\(P. 87\)](#)

LINKS

[▶Configuring Ethernet Settings\(P. 47\)](#)

[▶Setting a Wait Time for Connecting to a Network\(P. 50\)](#)

Setting a Wait Time for Connecting to a Network

7YX2-018

When a network is designed to enjoy redundant connectivity with multiple switching hubs or bridges, it must have a mechanism to prevent packets from looping. One effective solution is to define the role of each switch port. However, communication may still be disrupted for several tens of seconds immediately after you change the way that network devices are connected, or if you add a new device. If this type of problem occurs, set a wait time for connecting to the network.

- 1** Select **<Menu>** in the Home screen. **▶Home Screen(P. 91)**
- 2** Select **<Preferences>** ▶ **<Network>**.
 - If the login screen appears, enter the correct ID and PIN. **▶Logging in to the Machine(P. 100)**
- 3** Select **<Waiting Time for Connection at Startup>**.
- 4** Enter the waiting time required to start a communication with the network, and press **OK**.

LINKS

- ▶Configuring Ethernet Settings(P. 47)**
- ▶Changing the Maximum Transmission Unit(P. 49)**

Configuring DNS

7YX2-019

DNS (Domain Name System) provides a service for name resolution that associates a host (or domain) name with an IP address. Configure the DNS, mDNS, or DHCP option settings as necessary. Note that the procedures for configuring DNS are different for IPv4 and IPv6.

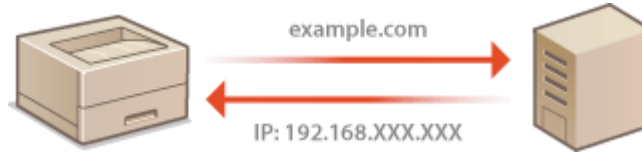

NOTE

- For more information about the basic operations to be performed when setting the machine from the Remote UI, see [▶Setting Up Menu Options from Remote UI\(P. 237\)](#) .

- 1 Start the Remote UI and log in to System Manager Mode.** [▶Starting Remote UI\(P. 228\)](#)
- 2 Click [Settings/Registration] on the Portal page.** [▶Remote UI Screen\(P. 229\)](#)
- 3 Click [Network Settings].**
- 4 Configure DNS settings.**

■Configuring IPv4 DNS

- 1** Select [IPv4 Settings] ▶ [Edit].
- 2** Configure IPv4 DNS settings.

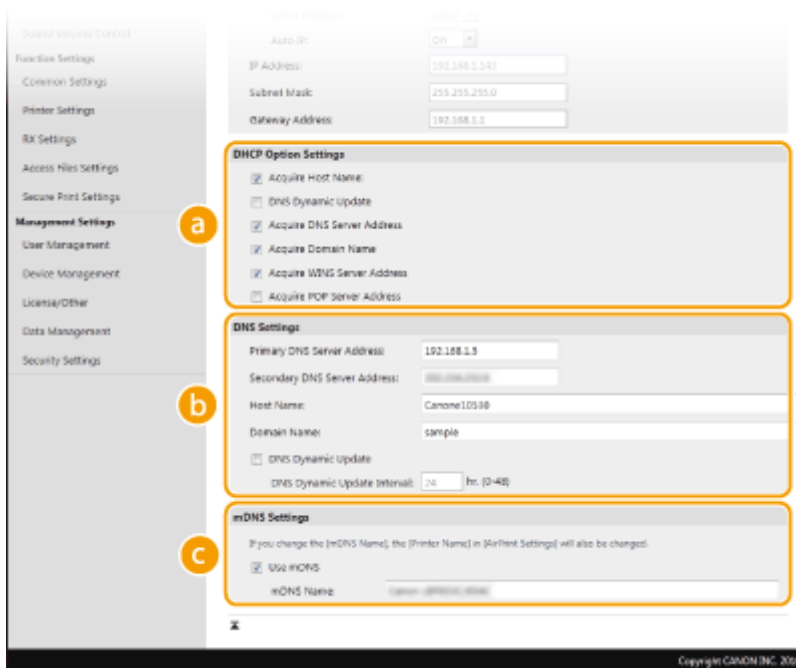

a [DHCP Option Settings]

[Acquire Host Name]

Select the check box to enable Option 12 to obtain the host name from the DHCP server.

[DNS Dynamic Update]

Select the check box to enable Option 81 to dynamically update the DNS records through the DHCP server.

[Acquire DNS Server Address]

Select the check box to enable Option 6 to obtain a DNS server address from the DHCP server.

[Acquire Domain Name]

Select the check box to enable Option 15 to obtain a domain name from the DHCP server.

[Acquire WINS Server Address]

Select the check box to enable Option 44 to obtain a WINS server address from the DHCP server.

[Acquire POP Server Address]

Select the check box to enable Option 70 to obtain a POP3 server address from the DHCP server.

b [DNS Settings]

[Primary DNS Server Address]

Enter the IP address of a DNS server.

[Secondary DNS Server Address]

Enter the IP address of a secondary DNS server, if any.

[Host Name]

Enter alphanumeric characters for the host name of the machine that is to be registered to the DNS server.

[Domain Name]

Enter alphanumeric characters for the name of the domain the machine belongs to, such as "example.com."

[DNS Dynamic Update]

Select the check box to dynamically update the DNS records whenever the machine's IP address is changed. When specifying the interval between updates, enter the time in hours in the [DNS Dynamic Update Interval] text box.

c [mDNS Settings]

[Use mDNS]

Adopted by Bonjour, mDNS (multicast DNS) is a protocol for associating a host name with an IP address without using DNS. Select the check box to enable mDNS and enter the mDNS name in the [mDNS Name] text box.

3 Click [OK].

■ Configuring IPv6 DNS

1 Select [IPv6 Settings] ► [Edit].

2 Configure IPv6 DNS settings.

- The [Use IPv6] check box must be selected to configure the settings. [Setting IPv6 Addresses\(P. 31\)](#)

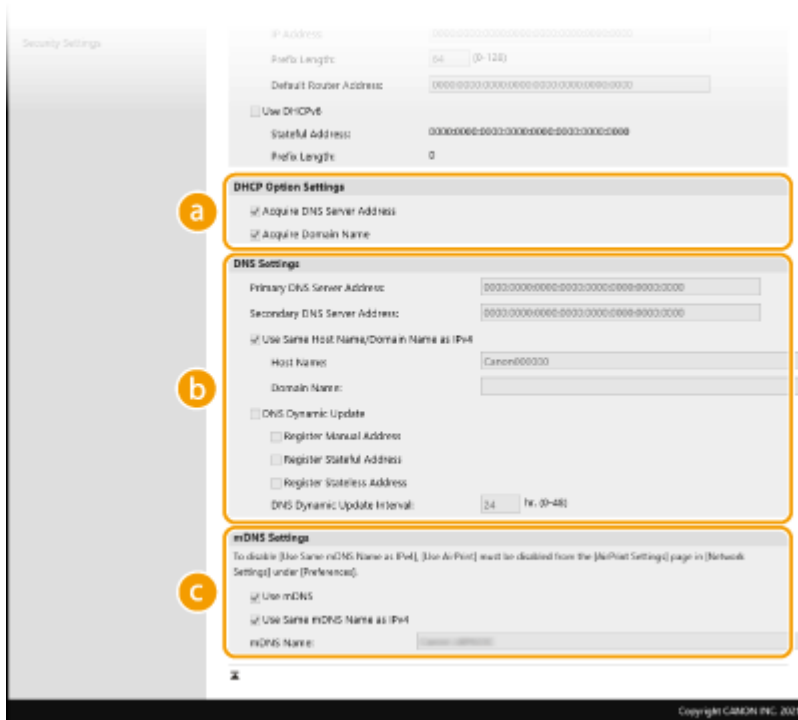

a [DHCP Option Settings]

[Acquire DNS Server Address]

Select the check box to enable Option 23 to obtain a DNS server address from the DHCP server.

[Acquire Domain Name]

Select the check box to enable Option 24 to obtain a domain name from the DHCP server.

b [DNS Settings]

[Primary DNS Server Address]

Enter the IP address of a DNS server. Addresses that start with "ff" (or multicast address) cannot be entered.

[Secondary DNS Server Address]

Enter the IP address of a secondary DNS server, if any. Addresses that start with "ff" (or multicast address) cannot be entered.

[Use Same Host Name/Domain Name as IPv4]

Select the check box to use the same host and domain names as in IPv4.

[Host Name]

Enter alphanumeric characters for the host name of the machine that is to be registered to the DNS server.

[Domain Name]

Enter alphanumeric characters for the name of the domain the machine belongs to, such as "example.com."

[DNS Dynamic Update]

Select the check box to dynamically update the DNS records whenever the machine's IP address is changed. To specify the type(s) of addresses you want to register to the DNS server, select the check box for [Register Manual Address], [Register Stateful Address], or [Register Stateless Address]. To specify the interval between updates, enter the time in hours in the [DNS Dynamic Update Interval] text box.

 [mDNS Settings]**[Use mDNS]**

Adopted by Bonjour, mDNS (multicast DNS) is a protocol for associating a host name with an IP address without using DNS. Select the check box to enable mDNS.

[Use Same mDNS Name as IPv4]



Select the check box to use the same mDNS name as in IPv4. To set a different name, clear the check box and enter the mDNS name in the [mDNS Name] text box.

3 Click [OK].



5 Restart the machine.  **Restarting the Machine(P. 87)**

NOTE

Selecting settings from the operation panel

- DNS settings can also be accessed from <Menu> in the Home screen.
 -  <IPv4 Settings>(P. 270)
 -  <IPv6 Settings>(P. 272)

LINKS

-  **Setting IPv4 Address(P. 28)**
-  **Setting IPv6 Addresses(P. 31)**
-  **Viewing Network Settings(P. 34)**

Configuring SMB

7YX2-01A

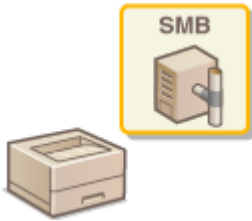

Server Message Block (SMB) is a protocol for sharing resources, such as files and printers, among multiple devices on a network. You need to use it to configure the machine as a shared printer on an SMB network. Depending on your network, you may have to set the computer name and workgroup name.

NOTE

- For more information about the basic operations to be performed when setting the machine from the Remote UI, see [▶Setting Up Menu Options from Remote UI\(P. 237\)](#) .

Configuring the Computer Name and Workgroup Name

Specify the name of the machine on the network and the name of the workgroup it belongs to. If your environment does not have workgroups, create a workgroup in Windows and enter the name of that workgroup.

- 1 Start the Remote UI and log in to System Manager Mode. [▶Starting Remote UI\(P. 228\)](#)
- 2 Click [Settings/Registration] on the Portal page. [▶Remote UI Screen\(P. 229\)](#)
- 3 Select [Network Settings] ▶ [Computer Name/Workgroup Name Settings].
- 4 Click [Edit].
- 5 Specify the required settings.

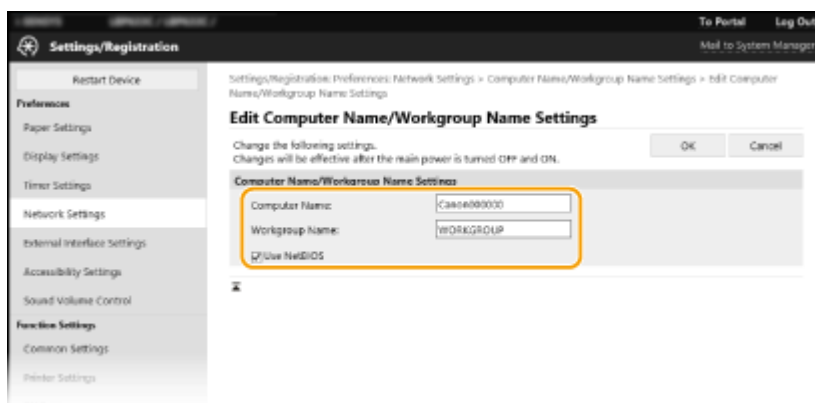

[Computer Name]

Enter alphanumeric characters for the name of the machine on the network.

[Workgroup Name]

Workgroup name is a name for grouping multiple computers so that basic network functions, such as file sharing, become available in a Windows network. Enter alphanumeric characters for the name of the workgroup that the machine belongs to.

[Use NetBIOS]

Select the check box when using NetBIOS.

! IMPORTANT:

- Computer names or workgroup names that start with an asterisk (*) cannot be registered to a WINS server.

6 Click [OK].

7 Restart the machine. ▶ [Restarting the Machine\(P. 87\)](#)

LINKS

▶ [Configuring WINS\(P. 57\)](#)

Configuring WINS

7YX2-01C

Windows Internet Name Service (WINS) is a name resolution service that associates a computer or printer name in an SMB network with an IP address. To enable WINS, the WINS server must be specified.

! IMPORTANT

- In order to specify WINS server settings, [Computer Name/Workgroup Name Settings] are required to be set. [▶Configuring the Computer Name and Workgroup Name\(P. 55\)](#)
- If you clear [Use NetBIOS] check box in [Computer Name/Workgroup Name Settings], the WINS setting is disabled. Make sure to select [Use NetBIOS] check box when using WINS.
- The function is not available in an IPv6 network.

NOTE

- For more information about the basic operations to be performed when setting the machine from the Remote UI, see [▶Setting Up Menu Options from Remote UI\(P. 237\)](#) .

- 1 Start the Remote UI and log in to System Manager Mode. [▶Starting Remote UI\(P. 228\)](#)**
- 2 Click [Settings/Registration] on the Portal page. [▶Remote UI Screen\(P. 229\)](#)**
- 3 Select [Network Settings] ▶ [WINS Settings].**
- 4 Click [Edit].**
- 5 Select the [WINS Resolution] check box, and specify the required settings.**

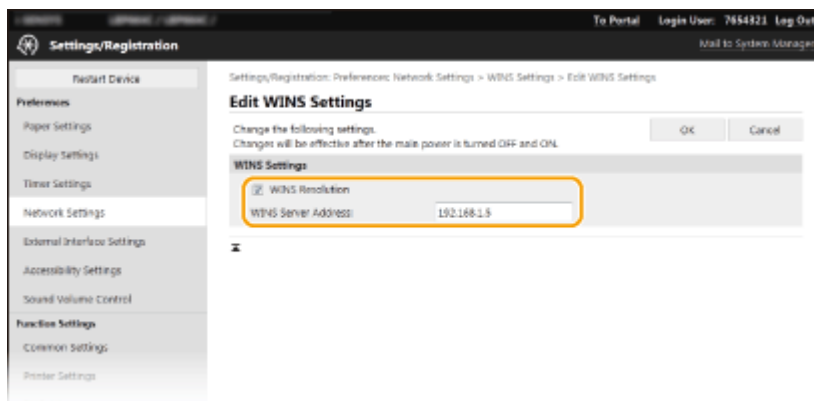

[WINS Resolution]

Select the check box to use WINS for name resolution. When not using WINS, clear the check box.

[WINS Server Address]

Enter the IP address of the WINS server.

! IMPORTANT:

- If the IP address of the WINS server is obtained from a DHCP server, the obtained IP address overrides the IP address entered in the [WINS Server Address] text box.

6 Click [OK].

7 Restart the machine. ▶ [Restarting the Machine\(P. 87\)](#)

NOTE

Selecting settings from the operation panel

- WINS settings can also be accessed from <Menu> in the Home screen. ▶ [<WINS Settings>\(P. 274\)](#)

LINKS

▶ [Setting IPv4 Address\(P. 28\)](#)

Monitoring and Controlling the Machine with SNMP

7YX2-01E

Simple Network Management Protocol (SNMP) is a protocol for monitoring and controlling communication devices in a network by using Management Information Base (MIB). The machine supports SNMPv1 and security-enhanced SNMPv3. You can check the status of the machine from a computer when you print documents or use the Remote UI. You can enable either SNMPv1 or SNMPv3, or both at the same time. Specify the settings for each version to suit your network environment and the purpose of use.

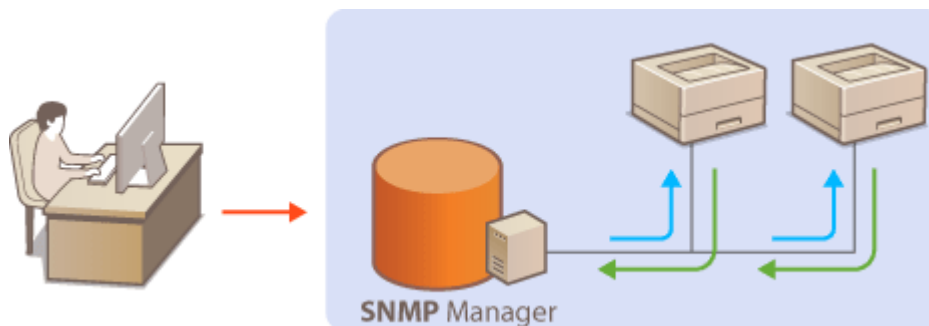

SNMPv1

SNMPv1 uses information called "community" to define the scope of SNMP communication. Because this information is exposed to the network in plain text, your network will be vulnerable to attacks. If you want to ensure network security, disable SNMPv1 and use SNMPv3.

SNMPv3

With SNMPv3, you can implement network device management that is protected by robust security features. Note that TLS must be enabled for the Remote UI before configuring SNMPv3 ([▶Configuring the Key and Certificate for TLS\(P. 195\)](#)).

NOTE

- The machine does not support the trap notification feature of SNMP.
- To change the port number of SNMP, see [▶Changing Port Numbers\(P. 192\)](#) .
- SNMP management software, when installed on a computer on the network, enables you to configure, monitor, and control the machine remotely from the computer. For more information, see the instruction manuals for your management software.
- For more information about the basic operations to be performed when setting the machine from the Remote UI, see [▶Setting Up Menu Options from Remote UI\(P. 237\)](#) .

- 1 Start the Remote UI and log in to System Manager mode. [▶Starting Remote UI\(P. 228\)](#)**
- 2 Click [Settings/Registration] on the Portal page. [▶Remote UI Screen\(P. 229\)](#)**
- 3 Select [Network Settings] ▶ [SNMP Settings].**
- 4 Click [Edit].**

5 Specify SNMPv1 settings.

- If you do not need to change SNMPv1 settings, proceed to the next step.

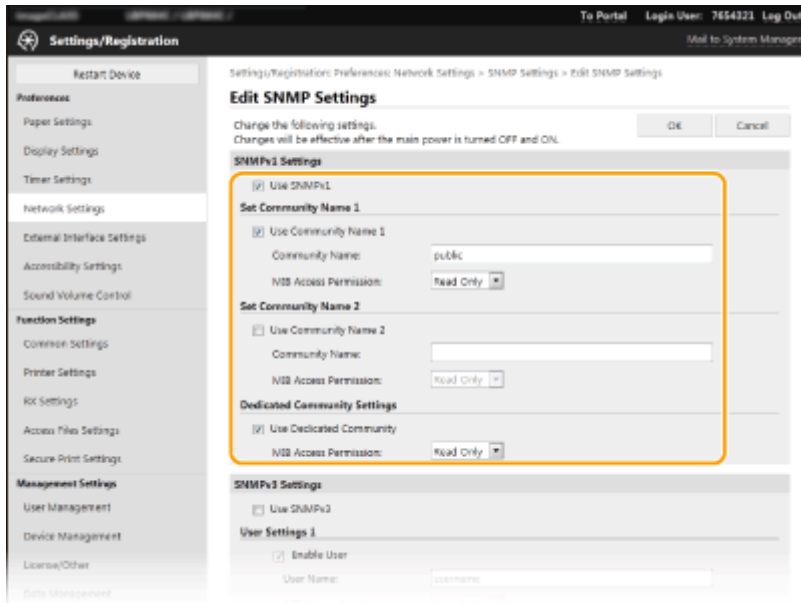

[Use SNMPv1]

Select the check box to enable SNMPv1. You can specify the rest of SNMPv1 settings only when this check box is selected.

[Use Community Name 1]/[Use Community Name 2]

Select the check box to specify a community name. If you do not need to specify a community name, clear the check box.

[Community Name]

Enter alphanumeric characters for the name of the community.

[MIB Access Permission]

For each community, select [Read/Write] or [Read Only] for the access privileges to MIB objects.

[Read/Write]	Permits both viewing and changing the values of MIB objects.
[Read Only]	Permits only viewing the values of MIB objects.

[Use Dedicated Community]

Dedicated Community is a preset community, intended exclusively for Administrators using Canon software, such as iW Management Console. Select the check box to use Dedicated Community, and specify [MIB Access Permission]. If you do not need to use Dedicated Community, clear the check box.

6 Specify SNMPv3 settings.

- If you do not need to change SNMPv3 settings, proceed to the next step.

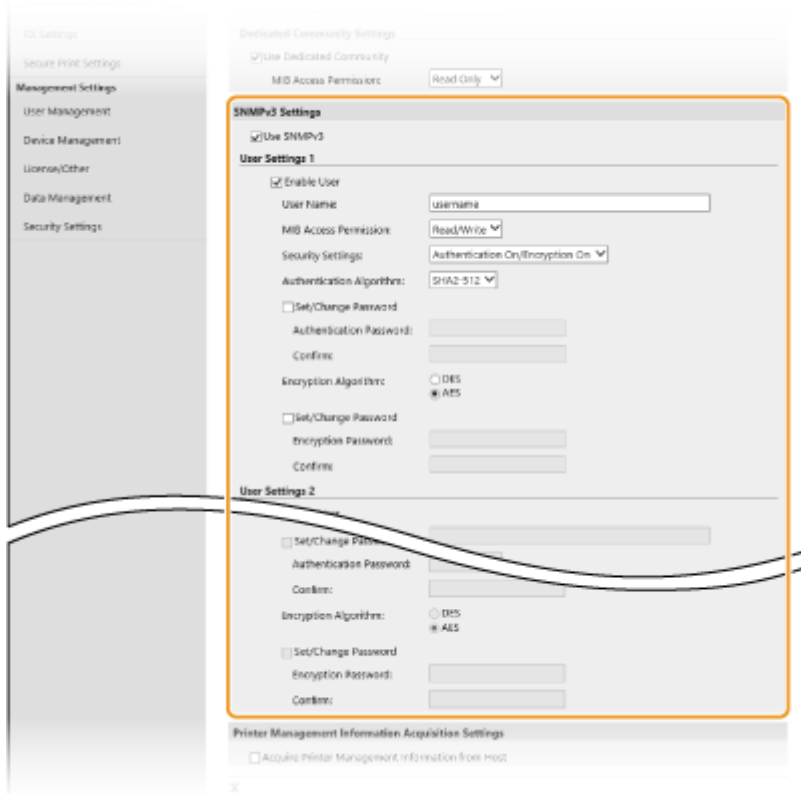

[Use SNMPv3]

Select the check box to enable SNMPv3. You can specify the rest of SNMPv3 settings only when this check box is selected.

[Enable User]

Select the check box to enable [User Settings 1]/[User Settings 2]/[User Settings 3]. To disable user settings, clear the corresponding check box.

[User Name]

Enter alphanumeric characters for the user name.

[MIB Access Permission]

Select [Read/Write] or [Read Only] for the access privileges to MIB objects.

[Read/Write]	Permits both viewing and changing the values of MIB objects.
[Read Only]	Permits only viewing the values of MIB objects.

[Security Settings]

Select [Authentication On/Encryption On], [Authentication On/Encryption Off], or [Authentication Off/Encryption Off] for the desired combination of authentication and encryption settings.

[Authentication Algorithm]

If you have selected [Authentication On/Encryption On] or [Authentication On/Encryption Off] in [Security Settings], select the appropriate authentication algorithm for your network environment.

[Encryption Algorithm]

If you have selected [Authentication On/Encryption On] in [Security Settings], select the appropriate encryption algorithm for your network environment.

[Set/Change Password]

To set or change the password, select the check box and enter alphanumeric characters for the password in the [Authentication Password] or [Encryption Password] text box. For confirmation, enter the same password in the [Confirm] text box. Passwords can be set independently for authentication and encryption algorithms.

7 Specify Printer Management Information Acquisition Settings.

- With SNMP, the printer management information, such as printing protocols and printer ports, can be monitored and obtained regularly from a computer on the network.

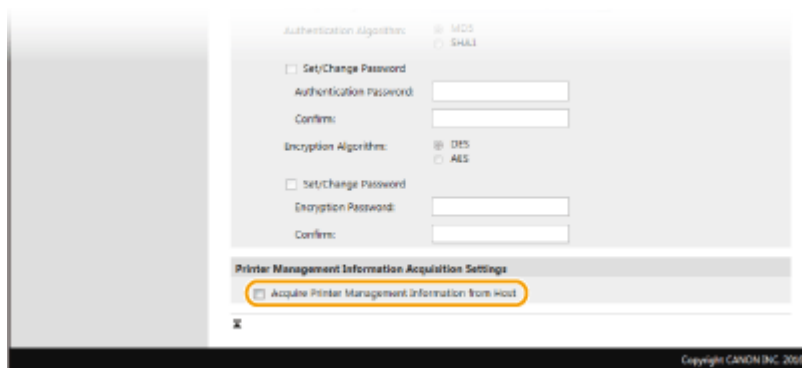

[Acquire Printer Management Information from Host]

Select the check box to enable monitoring of the printer management information of the machine via SNMP. To disable monitoring of the printer management information, clear the check box.

8 Click [OK].

9 Restart the machine. ▶ **Restarting the Machine(P. 87)**

NOTE

Disabling SNMPv1

- If SNMPv1 is disabled, some of the functions of the machine become unavailable, such as obtaining machine information via the printer driver.

Using the operation panel

- You can enable or disable the SNMP settings from <Menu>. ▶ **<SNMP Settings>(P. 276)**

Enabling Both SNMPv1 and SNMPv3

- If both versions of SNMP are enabled, it is recommended that MIB access permission in SNMPv1 be set to [Read Only]. MIB access permission can be set independently in SNMPv1 and SNMPv3 (and for each user in SNMPv3). Selecting [Read/Write] (full access permission) in SNMPv1 negates the robust security features that characterize SNMPv3 because most of the machine settings can then be controlled with SNMPv1.

LINKS

▶ **Configuring the Key and Certificate for TLS(P. 195)**

Other Network Settings

7YX2-01F

Configure the following items according to your network environment.

- ▶ **Configuring SNTP(P. 63)**
- ▶ **Monitoring the Machine from the Device Management Systems(P. 64)**

Configuring SNTP

Simple Network Time Protocol (SNTP) enables you to adjust the system clock by using the time server on the network. If SNTP is used, the time server is checked at the specified intervals; therefore, the correct time can always be maintained. The time is adjusted based on Coordinated Universal Time (UTC), so specify the time zone setting before configuring SNTP (▶ **Setting the Date/Time(P. 9)**). SNTP settings can be specified via the Remote UI.

NOTE

- The SNTP of the machine supports both NTP (version 3) and SNTP (versions 3 and 4) servers.
- For more information about the basic operations to be performed when setting the machine from the Remote UI, see ▶ **Setting Up Menu Options from Remote UI(P. 237)** .

- 1** Start the Remote UI and log in to System Manager Mode. ▶ **Starting Remote UI(P. 228)**
- 2** Click [Settings/Registration] on the Portal page. ▶ **Remote UI Screen(P. 229)**
- 3** Select [Network Settings] ▶ [SNTP Settings].
- 4** Click [Edit].
- 5** Select the [Use SNTP] check box and specify the required settings.



[Use SNTP]

Select the check box to use SNTP for synchronization. If you do not want to use SNTP, clear the check box.

[NTP Server Name]

Enter the IP address of the NTP or the SNTP server. If DNS is available on the network, you can enter a host name (or FQDN) consisting of alphanumeric characters instead (example: ntp.example.com).

[Polling Interval]

Specify the interval between one synchronization and the next.

6 Click [OK].

7 Restart the machine. ▶ Restarting the Machine(P. 87)

NOTE

Testing communication with the NTP/SNTP server

- You can view communication status with the registered server by clicking [Settings/Registration] ▶ [Network Settings] ▶ [Check NTP Server] in [SNTP Settings]. If a proper connection has been established, the result is displayed as shown below. Note that this operation does not adjust the system clock.

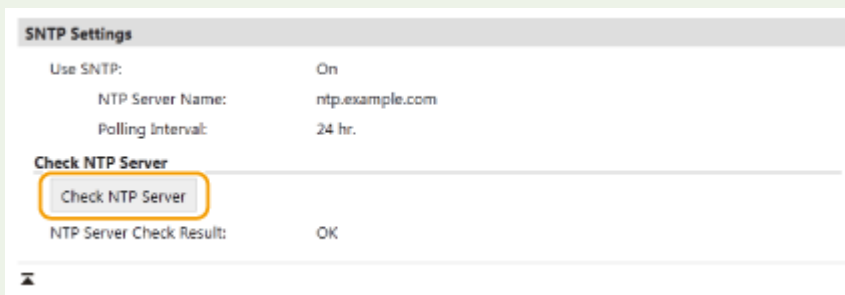

Monitoring the Machine from the Device Management Systems

You can facilitate the collection and management of various information about networked devices by implementing device management software, such as iW Management Console*, into the network. Information such as device settings and error logs is retrieved and distributed via the server computer. If the machine is connected to such a network, iW Management Console searches the network for the machine by using protocols such as Service Location Protocol (SLP) to gather information from the machine, such as power supply status information. SLP settings can be specified via the Remote UI. This section also describes the procedure to configure settings for communication between the machine and plug-ins for iW Management Console.

*For more information about iW Management Console, contact your dealer or service representative.

NOTE

To use iW Management Console plug-ins

- You need to enable the settings of the dedicated port and the SNMP settings. As for the SNMP settings, set [MIB Access Permission] to [Read/Write] for both SNMPv1 and SNMPv3.
 - ▶ <Dedicated Port Settings>(P. 277)
 - ▶ Monitoring and Controlling the Machine with SNMP(P. 59)

Remote UI Operations

- For more information about the basic operations to be performed when setting the machine from the Remote UI, see ▶ Setting Up Menu Options from Remote UI(P. 237) .

■ Configuring SLP Communication with Device Management Software

- 1 Start the Remote UI and log in to System Manager Mode. ▶ Starting Remote UI(P. 228)
- 2 Click [Settings/Registration] on the Portal page. ▶ Remote UI Screen(P. 229)
- 3 Click [Network Settings].
- 4 Specify SLP settings.

■ Specifying multicast device discovery

- 1 Select [Multicast Discovery Settings] ▶ [Edit].
- 2 Select the [Respond to Discovery] check box and specify the required settings.

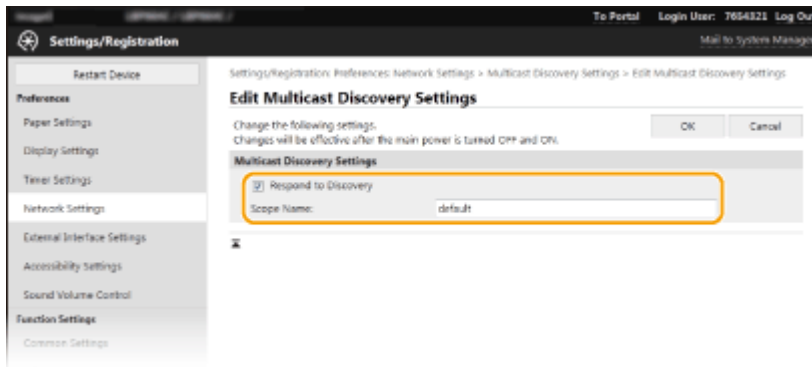

[Respond to Discovery]

Select the check box to set the machine to respond to device management software multicast discovery packets and enable monitoring by device management software.

NOTE:

- To change the port number for multicast discovery, see ▶ Changing Port Numbers(P. 192) .

[Scope Name]

To include the machine into a specific scope, enter alphanumeric characters for the scope name.

- 3 Click [OK].

■ Notifying a device management software of the power status of the machine

- 1 Select [Sleep Mode Notification Settings] ▶ [Edit].
- 2 Select the [Notify] check box and specify the required settings.

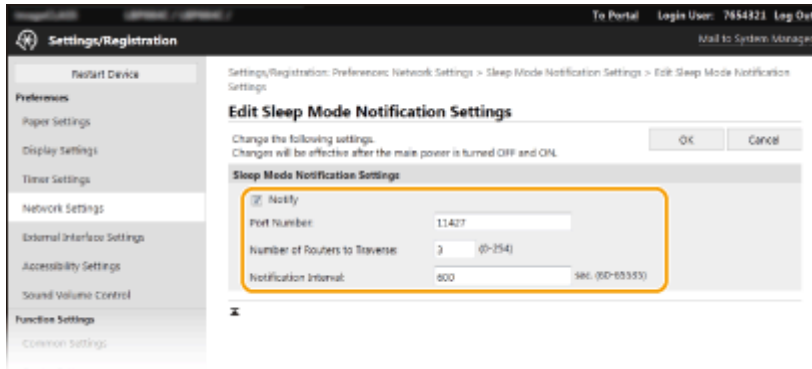

[Notify]

Select the check box to notify a device management software of the power status of the machine. When [Notify] is selected, you can expect the machine to avoid unnecessary communication during sleep mode and reduce the total power consumption.

[Port Number]

Change the port number for this function settings according to the network environment.

[Number of Routers to Traverse]

Specify how many routers the notification packets can pass through.

[Notification Interval]

Specify how often the machine notifies a device management software of its power status.

3 Click [OK].

5 Restart the machine. ▶ Restarting the Machine(P. 87)

■ Configuring Settings for Communication between the Machine and Plug-ins

You can specify the settings to enable communication between the machine and iW Management Console plug-ins. Use of plug-ins allows you to manage the machine's settings from iW Management Console.



Installing Drivers

7YX2-01H

Install the various drivers and associated software on your computer.

1 Make the necessary preparation before proceeding with the installation.

- Install the optional devices on the main unit in advance. ▶ **Optional Equipment(P. 390)**
- Install the drivers and software to use from the included CD-ROM/DVD-ROM or by downloading them from the Canon website for your country/region accessed via the URL indicated below.
<https://global.canon/en/support/>

NOTE:

- When new versions of drivers and software become available, they will be uploaded to the Canon website. You can download them as necessary after checking their system requirements.
- Depending on your machine or environmental conditions, some functions may not be available.
- Some of the drivers are not supported depending on the OS. For more information about the supported status of the latest OS, see the Canon website.

2 Proceed with the installation.

- For more information about the installation procedure, see the manuals for the drivers and software you are going to use.

IMPORTANT

- Installation of drivers is impossible if sending and receiving of the IP address are not permitted in [Firewall Settings]. For more information, see ▶ **Specifying IP Addresses for Firewall Settings(P. 186)** .
- If sending and receiving of the IP address of the computer on which drivers are installed become disabled by [Firewall Settings], it is no longer possible to perform printing from that computer.

Basic Operations

Basic Operations	70
Parts and Their Functions	73
Front Side	74
Back Side	76
Interior	77
Multi-Purpose Tray	78
Paper Drawer	79
Operation Panel	80
Turning ON the Machine	82
Turning OFF the Machine	83
Turning OFF the Machine by Remote Operation	84
Powering OFF at a Fixed Time	85
Restarting the Machine	87
Using the Operation Panel	89
Basic Screens	90
Home Screen	91
<Status Monitor> Screen	92
Message Display	94
Basic Operation	95
Entering Text	97
Logging in to the Machine	100
Loading Paper	101
Loading Paper in the Paper Drawer	103
Loading Paper in the Multi-Purpose Tray	108
Loading Envelopes	111
Loading Preprinted Paper	113
Specifying Paper Size and Type	117
Specifying Paper Size and Type in the Paper Drawer	118
Specifying Paper Size and Type in the Multi-Purpose Tray	120
Registering Default Paper Settings for the Multi-Purpose Tray	122
Registering a Custom Paper Size	124
Limiting the Paper Sizes Displayed	126
Automatically Selecting an Appropriate Paper Source for Each Function	127
Customizing the Display	128
Customizing the Home Screen	129

Setting Sounds	130
Entering Sleep Mode	131
Using a USB Memory Device	133

Basic Operations

7YX2-01J

This chapter describes basic operations, such as how to use the operation panel or how to load the paper, that are frequently performed to use the functions of the machine.

■ Parts and Their Functions

This section describes the exterior and interior parts of the machine and their functions, as well as how to use the keys on the operation panel and how to view the display. ▶ **Parts and Their Functions(P. 73)**

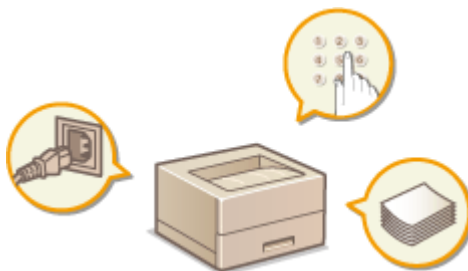

■ Turning ON the Machine

This section describes how to turn the machine ON and OFF. ▶ **Turning ON the Machine(P. 82)**



■ Using the Operation Panel

This section describes how to use the display for tasks such as selecting items and adjusting settings. Also, it describes how to enter characters and numbers. ▶ **Using the Operation Panel(P. 89)**



■ Logging in to the Machine

This section describes how to log in when a login screen is displayed. ▶ **Logging in to the Machine(P. 100)**



■ Loading Paper

This section describes how to load the paper into the paper drawer and multi-purpose tray. ▶ **Loading Paper(P. 101)**

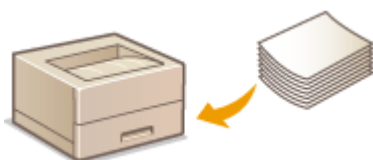

■ Customizing the Display

This section describes how to rearrange the displayed items in order to make it easier to use screens shown in the display. ▶ **Customizing the Display(P. 128)**



■ Setting Sounds

This section describes how to adjust the volume of various machine sounds, such as those produced when an error occurs. ▶ **Setting Sounds(P. 130)**



■ Entering Sleep Mode

This section describes how to set the sleep mode. ▶ **Entering Sleep Mode(P. 131)**



■ Using a USB Memory Device

This section describes about the available USB memory devices and how to insert/remove the USB memory device. ▶

Using a USB Memory Device(P. 133)

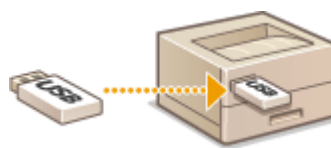

Parts and Their Functions

7YX2-01K

This section describes the parts of the machine (exterior, front and back side, and interior) and how they function. In addition to describing the parts of the machine used for such basic operations as loading paper and replacing the toner cartridges, this section also describes the keys on the operation panel and display. Read this section for tips on how to use the machine properly.



- ▶ **Front Side(P. 74)**
- ▶ **Back Side(P. 76)**
- ▶ **Interior(P. 77)**
- ▶ **Multi-Purpose Tray(P. 78)**
- ▶ **Paper Drawer(P. 79)**
- ▶ **Operation Panel(P. 80)**

Front Side

7YX2-01L

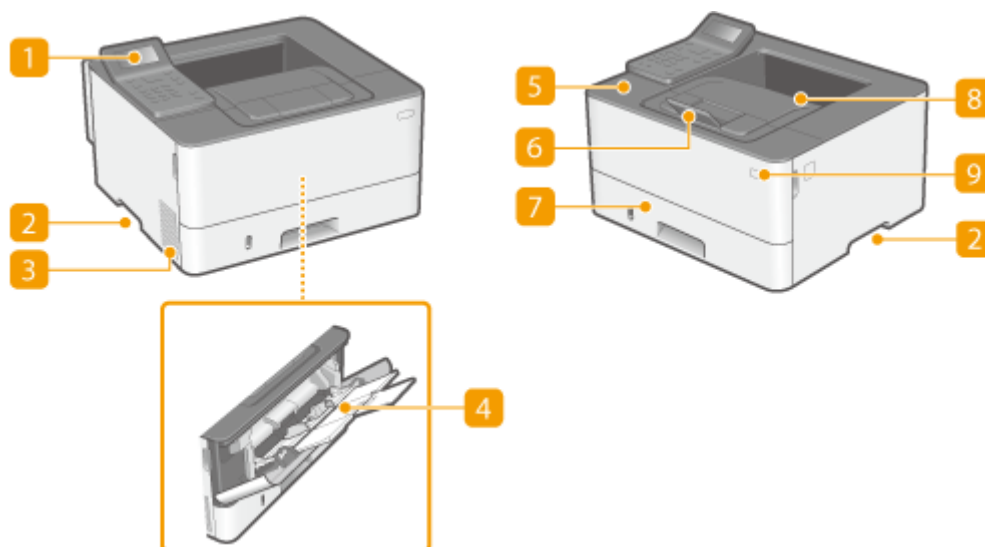

1 Operation panel

The operation panel consists of keys such as Home key, Stop key, a display, and status indicators. You can perform all the operations and specify settings from the operation panel.

▶ **Operation Panel(P. 80)**

▶ **Basic Screens(P. 90)**

2 Lift handles

Hold the lift handles when carrying the machine. ▶ **Relocating the Machine(P. 353)**

3 Ventilation slots

Air from inside the machine is vented out to cool down the inside of the machine. Note that placing objects in front of the ventilation slots prevents ventilation.

4 Multi-purpose tray

Load the paper into the multi-purpose tray when you want to temporarily use a type of paper different from that which is loaded in the paper drawer. ▶ **Loading Paper in the Multi-Purpose Tray(P. 108)**

5 Front cover

Open the front cover when replacing toner cartridges or removing jammed paper from inside the machine.

▶ **Procedure for Replacing the Toner Cartridge(P. 348)**

▶ **Interior(P. 77)**

6 Paper stopper

Open the paper stopper when you want to prevent paper from falling out of the output tray.

7 Paper drawer

Load the type of paper you frequently use into the paper drawer. ▶ **Loading Paper in the Paper Drawer(P. 103)**

8 Output tray

Printed paper is output to the output tray.

9 Power switch

Turns the power ON or OFF. To restart the machine, turn OFF the machine, wait for at least 10 seconds, and turn it back ON.

Back Side

7YX2-01R

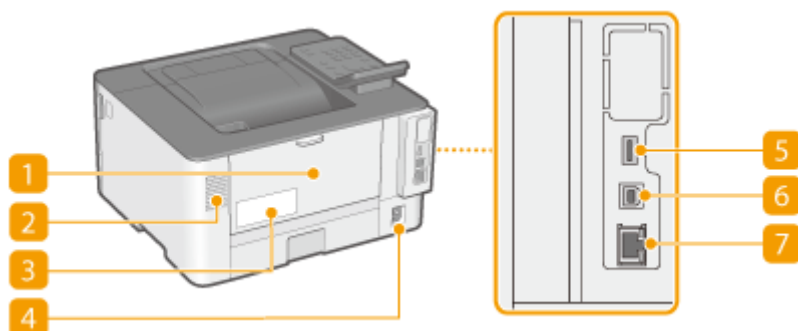

1 Rear cover

Open the rear cover when clearing paper jams. For more information, see "Troubleshooting (FAQ)" on the online manual website.

2 Ventilation slots

Air from inside the machine is vented out to cool down the inside of the machine. Note that placing objects in front of the ventilation slots prevents ventilation.

3 Rating label

The label shows the serial number, which is needed when making inquiries about the machine. For more information, see "Troubleshooting (FAQ)" on the online manual website.

4 Power socket

Connect the power cord.

5 USB port (for USB device connection)

Use this port to connect devices such as a third-party USB keyboard.

6 USB port (for computer connection)

Connect a USB cable when connecting the machine and a computer.

7 LAN port

Connect a LAN cable when connecting the machine to a wired LAN router, etc. ▶ **Connecting to a Wired LAN(P. 14)**

Interior

7YX2-01S

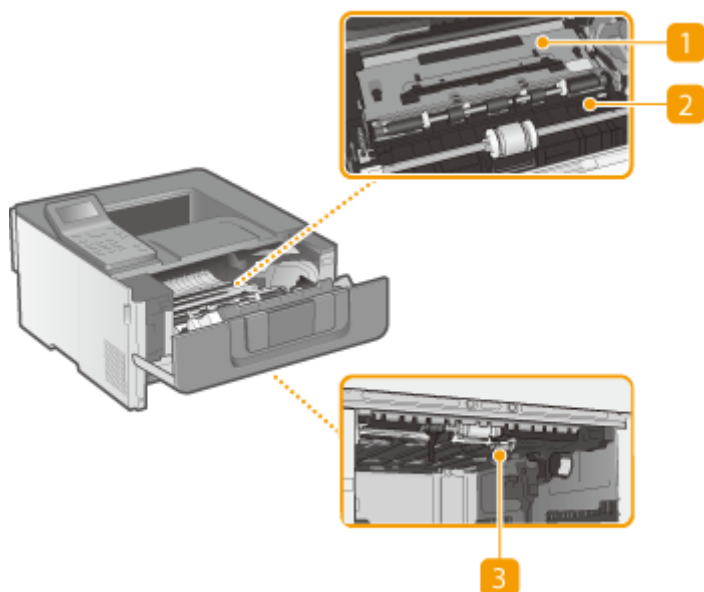

1 Transport guide (at the back)

If there is a paper jam inside the machine, raise the transport guide toward the front of the machine to remove the jammed paper. For more information, see "Troubleshooting (FAQ)" on the online manual website.

2 Transport guide (at the front)

If there is a paper jam inside the machine, raise the transport guide toward the back of the machine to remove the jammed paper. For more information, see "Troubleshooting (FAQ)" on the online manual website.

3 Duplex transport guide

If paper has jammed during 2-sided printing, lower the duplex transport guide to remove the jammed paper. For more information, see "Troubleshooting (FAQ)" on the online manual website.

Multi-Purpose Tray

7YX2-01U

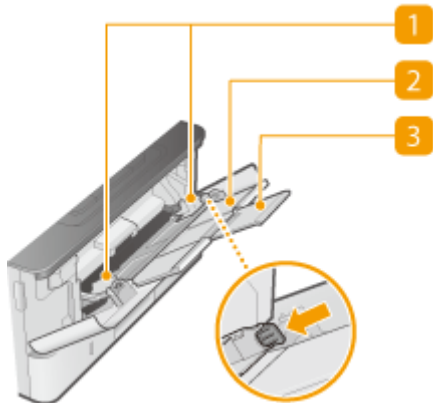

1 Paper guides

Adjust the paper guides to exactly the width of the loaded paper to ensure that paper is fed straight into the machine. Press the lock release lever that is indicated with an arrow in the illustration to release the lock and slide the paper guides.

2 Paper tray

Pull out the paper tray when loading paper.

3 Tray extension

Open the tray extension when loading large paper.

LINKS

▶ **Loading Paper in the Multi-Purpose Tray(P. 108)**

Paper Drawer

7YX2-01W

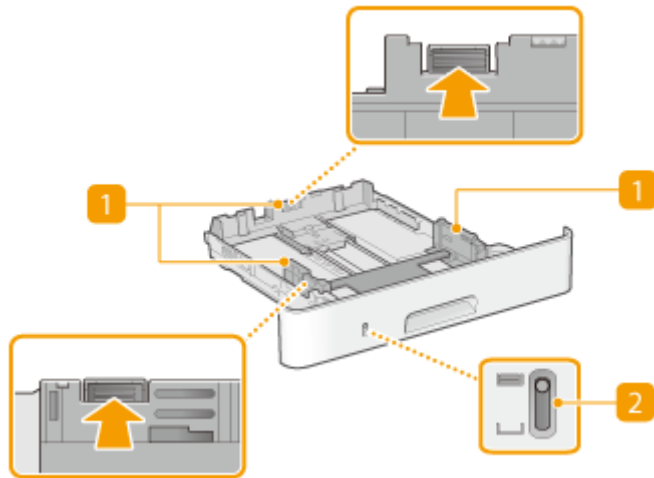

1 Paper guides

Adjust the paper guides to exactly the size of the loaded paper to ensure that paper is fed straight into the machine. Press the lock release levers that are indicated with arrows in the illustrations to release the locks and slide the paper guides.

2 Paper level indicator

Indicates the remaining amount of paper. The mark moves downward as the remaining amount of paper decreases.

LINKS

▶ [Loading Paper in the Paper Drawer\(P. 103\)](#)

Operation Panel

7YX2-01X

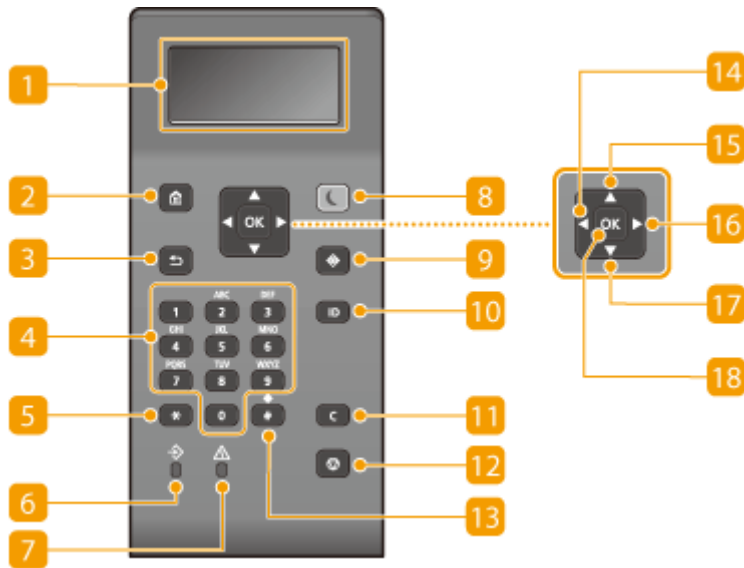

1 Display

You can view the operation and error statuses of this machine, the amount remaining in the toner cartridges, and other conditions. ▶ **Basic Screens(P. 90)**

2 Home key

Press to display the Home screen, which provides access to the setting menu and functions such as Secure Print. ▶ **Home Screen(P. 91)**

3 Back key

Press to return to the previous screen. If you press this key when specifying settings, for example, the settings are not applied and the display returns to the previous screen.

4 Numeric keys ([0]-[9] keys)

Press to enter numbers and text. ▶ **Entering Text(P. 97)**

5 [*] key

Press to switch the type of text that is entered.

6 Data indicator

Blinks while an operation is being performed, such as data transmission or printing. Lights up when there are documents waiting to be processed.

7 Error indicator

Blinks or lights up when an error such as a paper jam occurs.

8 Energy Saver key

Press to put the machine into sleep mode. The key lights up green when the machine is in sleep mode. Press the key again to exit sleep mode. ▶ **Entering Sleep Mode(P. 131)**

9 Status Monitor key

Press to check the printing status, to view the usage history, or to view the network settings such as the IP address of the machine. You can also check the status of the machine, such as the remaining amount of paper and the amount remaining in the toner cartridges, or whether any errors occurred. ▶ **<Status Monitor> Screen(P. 92)**

10 [ID] key

Press after entering the ID and PIN to log on when Department ID Management is enabled. After you finish using the machine, press this key again to log off. ▶ **Logging in to the Machine(P. 100)**

11 Clear key

Press to delete the entered numbers and text.

12 Stop key

Press to cancel printing and other operations.

13 [#] key

Press to enter symbols such as "@" or "/".

14 [◀] key

When specifying settings, press to return to the previous screen. When entering numbers, press to move the cursor to the left.

15 [▲] key

When specifying settings, press to select the item immediately above the currently selected item. When changing setting values, press to increase a value.

16 [▶] key

When specifying settings, press to proceed to the next screen. When entering numbers, press to move the cursor to the right.

17 [▼] key

When specifying settings, press to select the item immediately below the currently selected item. When changing setting values, press to decrease a value.

18 [OK] key

Press to apply settings or specified details.

LINKS

▶ **Basic Operation(P. 95)**

Turning ON the Machine

7YX2-01Y

This section describes how to turn ON the machine.

- 1 Make sure that the power plug is firmly inserted into a power outlet.**
- 2 Press the power switch.**

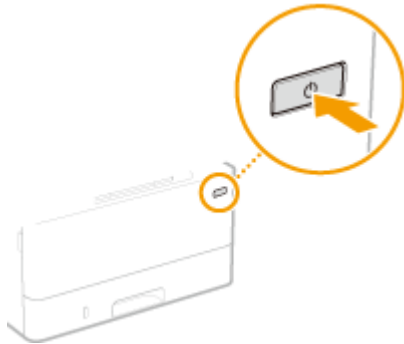

⇒ The Start screen appears. ▶ **Operation Panel(P. 80)**

NOTE

- You can select the screen that is displayed first after the machine is turned ON. ▶ **<Default Screen After Startup/Restoration>(P. 256)**

LINKS

- ▶ **Turning OFF the Machine(P. 83)**
- ▶ **Restarting the Machine(P. 87)**

Turning OFF the Machine

7YX2-020

This section describes how to turn OFF the machine.

1 Press the power switch.

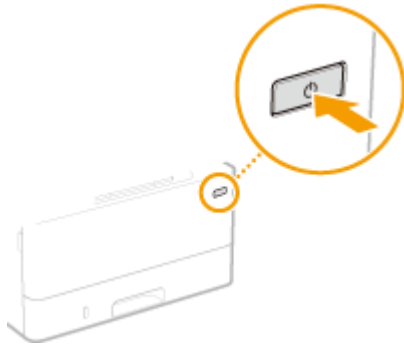

NOTE

- It may take some time for the machine to completely shut down. Do not unplug the power cord until the display turns off.
- To restart the machine, wait for at least 10 seconds after the machine is turned OFF.
- You can also turn OFF the machine from a computer. ▶ **Turning OFF the Machine by Remote Operation(P. 84)**
- You can specify the time for each day of the week and configure a setting to automatically turn OFF the machine. ▶ **Powering OFF at a Fixed Time(P. 85)**

Turning OFF the Machine by Remote Operation

7YX2-021

You can turn OFF the machine from a computer on the same network without going to where the machine is installed.

- 1 Start the Remote UI and log in to System Manager Mode.** ▶ Starting Remote UI(P. 228)
- 2 Click [Settings/Registration] on the Portal page.** ▶ Remote UI Screen(P. 229)
- 3 Select [Device Management] ▶ [Remote Shutdown].**
- 4 Check [Device Status] to make sure that no functions are being processed, and click [Execute].**
- 5 Click [OK].**

NOTE

Restarting the machine by remote operation

- You can restart the machine by clicking [Restart Device] on the [Settings/Registration] screen of the Remote UI. ▶ Restarting the Machine(P. 87)

Powering OFF at a Fixed Time

7YX2-022

You can make a setting so that the power is automatically turned OFF at a specified time on each day of the week. This allows you to avoid useless power consumption that may occur due to failure to turn OFF the power. By default, this function is disabled.

NOTE

- For information about the basic operation to set up the machine from Remote UI, see [▶Setting Up Menu Options from Remote UI\(P. 237\)](#).

- 1 Start the Remote UI and log in to System Manager Mode. [▶Starting Remote UI\(P. 228\)](#)
- 2 Click [Settings/Registration] on the Portal page. [▶Remote UI Screen\(P. 229\)](#)
- 3 Select [Timer Settings] ▶ [Edit].
- 4 Select the check box for [Set Auto Shutdown Weekly Timer], and set the time to turn OFF the power.

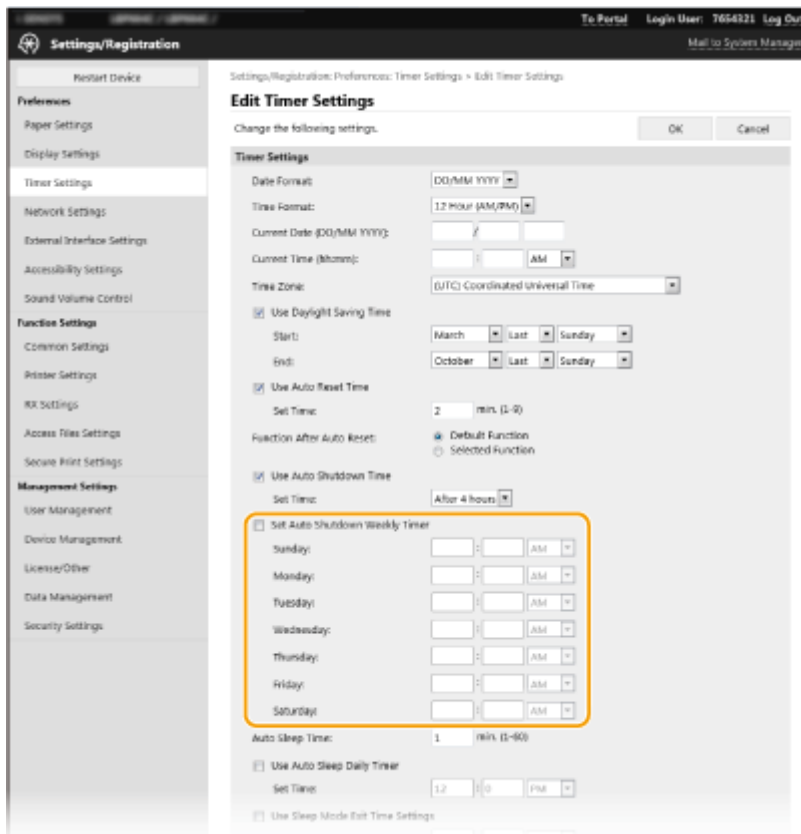

[Set Auto Shutdown Weekly Timer]

Selecting the check box allows you to set the time to turn OFF the power on each day of the week.

[Sunday] to [Saturday]

Enter the desired time to turn OFF the power. For any day of the week, leaving the time field blank means that the auto shutdown function is disabled for that day.

5 Click [OK].

NOTE

If the power is not turned OFF automatically at the specified time*

- When the Data indicator is lit up or blinking
- When the menu screen or Check Counter screen is displayed
- When settings data is being imported/exported
- When the firmware is being updated
- When <Control Condensation> is set to <On>

*If the power cannot be turned OFF automatically at the specified time, a retry will be performed up to ten times at intervals of one minute. If the power cannot be turned OFF even after ten retries, auto shutdown will be impossible for that day.

Restarting the Machine

7YX2-023

Depending on the setting items that have been changed, you may need to make the changes effective by restarting the machine. This section describes how to restart the machine.

- ▶ **Restarting the Machine by an Operation on the Main Unit(P. 87)**
- ▶ **Restarting the Machine by Remote Operation(P. 87)**

Restarting the Machine by an Operation on the Main Unit

1 Press the power switch.

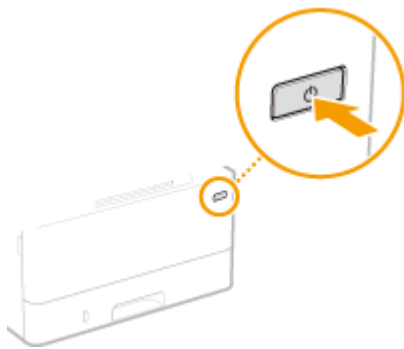

NOTE:

- It may take some time for the machine to completely shut down.
- ⇒ When the machine shuts down, the display or Energy Saver key of the operation panel turns off.

2 Wait at least 10 seconds after the shutdown, then press the power switch again.

- ⇒ The machine starts.

Restarting the Machine by Remote Operation

- 1 Start the Remote UI and log in to System Manager Mode. ▶Starting Remote UI(P. 228)**
- 2 Click [Settings/Registration] on the Portal page. ▶Remote UI Screen(P. 229)**
- 3 Click [Restart Device] in the menu on the left side of the screen.**

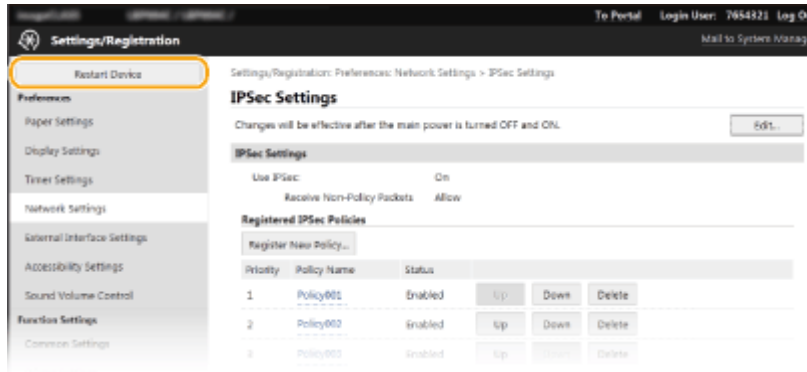

4 Check [Device Status] to make sure that no functions are being processed, and click [Execute].

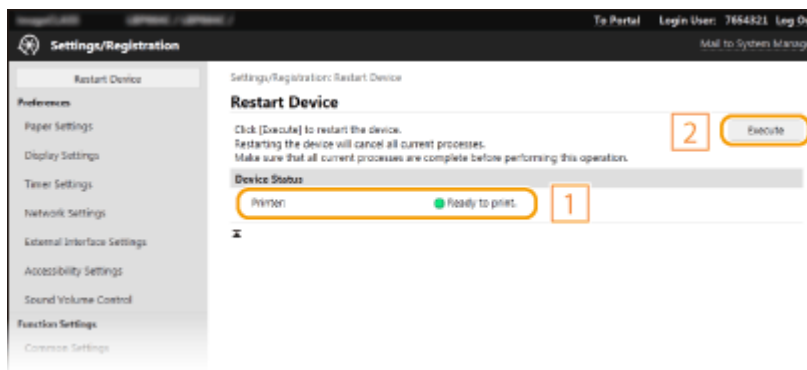

5 Click [OK].

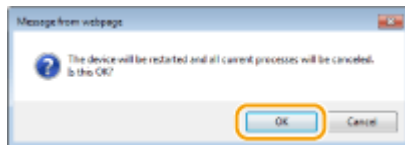

⇒ A restart process begins. Communication remains disconnected until the main unit has restarted.

Using the Operation Panel

7YX2-024

You can use the display and keys of the operation panel to configure machine settings or operate functions. This section describes basic usage of the display and keys.



- ▶ **Basic Screens(P. 90)**
- ▶ **Basic Operation(P. 95)**
- ▶ **Entering Text(P. 97)**

TIPS

- If you want to invert the light and dark parts of the display: ▶ **<Invert Screen Colors>(P. 282)**
- If you want to adjust the brightness of the display: ▶ **<Brightness>(P. 282)**
- If you want to adjust the contrast of the display: ▶ **<Contrast>(P. 282)**

LINKS

- ▶ **Operation Panel(P. 80)**

Basic Screens

7YX2-025

The Home screen or settings screen appears on the display, allowing you to initiate functions such as Secure Print. You can also use the display to check information such as error messages and the machine's operation status.

- ▶ **Home Screen(P. 91)**
- ▶ **<Status Monitor> Screen(P. 92)**
- ▶ **Message Display(P. 94)**

NOTE

- You can customize the Home screen by rearranging frequently used buttons for easier access to the respective functions. ▶ **Customizing the Display(P. 128)**

Home Screen

The Home screen is displayed when the power is turned ON or by pressing  on the operation panel. Use this screen to specify settings for and register functions.

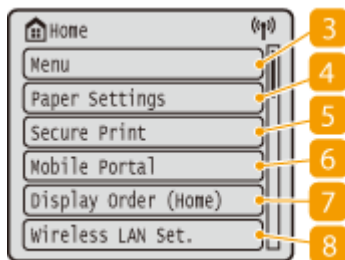
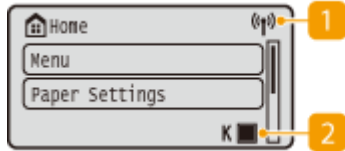

1 Wi-Fi icon

Displayed when the machine is connected to a wireless LAN.

2 Amount remaining in the toner cartridges

Displays the amount remaining in the toner cartridges in stages. This is hidden while the Home screen is active.

3 <Menu>

<Function Settings>, <Preferences>, and many other machine settings start from this button. ▶ **Setting Menu List(P. 254)**

4 <Paper Settings>

This button is used for specifying the size and type of paper loaded in the paper drawer and multi-purpose tray. ▶ **Specifying Paper Size and Type(P. 117)**

5 <Secure Print>

Use this function to print a secure document. ▶ **Printing a Document Secured by a PIN (Secure Print)(P. 143)**

6 <Mobile Portal>

Use this to establish a connection to a mobile device. ▶ **Connecting with Mobile Devices(P. 152)**

7 <Display Order (Home)>

Allows you to change the order that Home screen buttons are displayed in. ▶ **Customizing the Home Screen(P. 129)**

8 <Wireless LAN Set.>

Use this button to configure the wireless LAN settings. ▶ **Connecting to a Wireless LAN(P. 15)**

LINKS

▶ **Customizing the Home Screen(P. 129)**

<Status Monitor> Screen

When you press , a screen appears in which you can check the progress of documents as well as the status of the machine and network setting information.

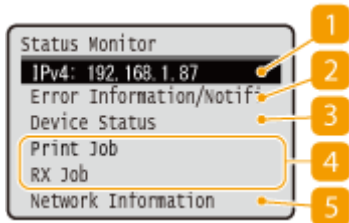

1 IP Address

Displays the IPv4 address of the machine.

NOTE:

- You can specify whether to display the IP address on the <Status Monitor> screen by setting <Display IP Address>.  <Display IP Address>(P. 260)

2 <Error Information/Notification>

Displays the details of any errors that occurred. For more information, see "Troubleshooting (FAQ)" on the online manual website.

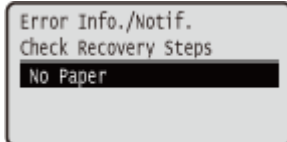

3 <Device Status>

Displays the status of the machine.

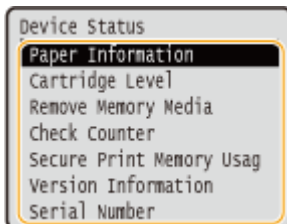

<Paper Information>

Displays whether paper is loaded in each paper source.

<Cartridge Level>

Displays the amount of toner remaining in the toner cartridges. Other internal parts may reach the end of their lifetime before the toner runs out.

<Remove Memory Media>

Used to safely remove a USB memory device. This is only displayed when a USB memory device is connected to the machine.  <Remove the USB Memory Device>(P. 133)

<Check Counter>

Displays the total volume of printouts.  <Viewing the Counter Value>(P. 359)

<Secure Print Memory Usage>

Displays the amount of memory currently used for storing secured document data. **▶Printing a Document Secured by a PIN (Secure Print)(P. 143)**

<Version Information>

Displays firmware version information.

<Serial Number>

Displays the serial number of the machine.

4 Status and logs of printed and received documents

Displays the current status of the selected item. The <Print Job Status> screen is shown below as an example.



5 <Network Information>

Displays the network settings such as the IP address of the machine and status such as the condition of wireless LAN communications. **▶Viewing Network Settings(P. 34)**

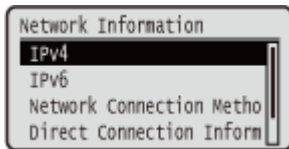

Message Display

7YX2-028

Messages are displayed on the screen in situations such as when paper runs out or when the expiration of the toner cartridge lifetime is reached. For more information, see "Troubleshooting (FAQ)" on the online manual website.

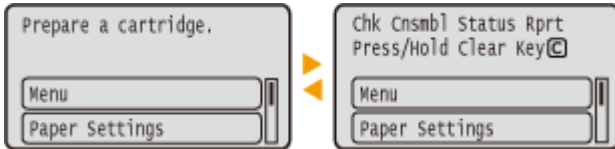

When an Error Occurs

In some cases when an error occurs, instructions on how to respond to the error are displayed. Follow the on-screen instructions to solve the problem. The screen displayed when a paper jam occurs is shown below as an example.

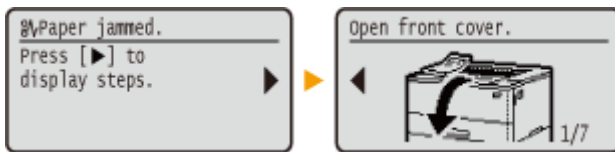

Basic Operation

7YX2-029

Use the keys shown below to specify settings and adjust values.

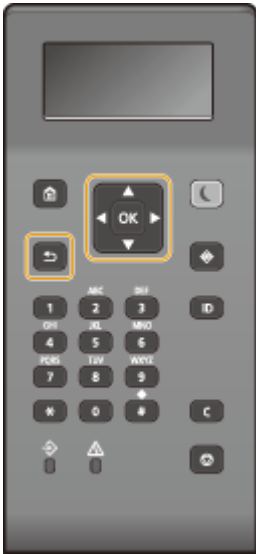

Using ▲ / ▼

■ Scrolling the Screen

The scroll bar is displayed on the right side of the screen when not all of the information fits on one screen. If the scroll bar is displayed, use ▲ / ▼ to scroll up or down. The text and background colors of an item are inverted when it is selected.

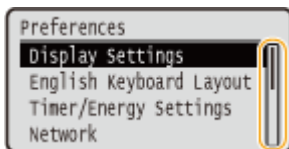

■ Changing Setting Values

Use ▲ / ▼ to enter values. If an icon such as below is displayed at the upper left of the screen, you can enter values directly using the numeric keys. ▶ **Entering Text(P. 97)**

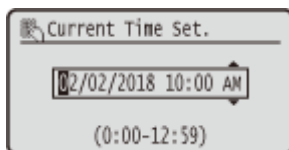

NOTE:

- Values in () displayed below the entry box are the enterable value range.

Using ◀ / ▶

■ Proceeding to the Next Screen/Returning to the Previous Screen

Press ▶ to proceed to the next screen. Press ◀ to return to the previous screen.

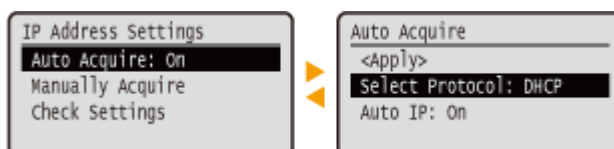

NOTE:

- You can also proceed to the next screen by pressing **OK**, and return to the previous screen by pressing **↶**.

■ Changing Setting Values

Use **◀ / ▶** to adjust the slider scale.

**■ Moving the Cursor**

Use **◀ / ▶** to enter text and values. **▶ Entering Text(P. 97)**

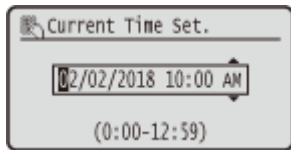
**Using **OK****

Press **OK** to apply a setting.

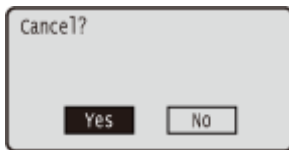
**Using the Numeric Keys**

Use the numeric keys to enter text and values. **▶ Entering Text(P. 97)**

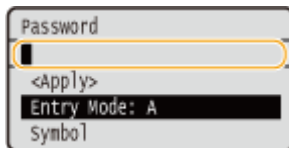
**TIPS**

- You can change a variety of display-related settings, such as the display language: **▶ <Display Settings>(P. 256)**
- You can change the screen that is automatically displayed when the machine remains idle for a specified length of time: **▶ <Function After Auto Reset>(P. 264)**
- You can change a variety of accessibility-related settings, such as the scroll speed: **▶ <Accessibility>(P. 282)**

Entering Text

7YX2-02A

Use the numeric keys to enter text and values.



Switching the Type of Text

Press ***** to switch the type of text that is entered.

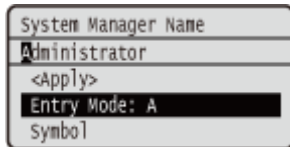

NOTE

- You can also select <Entry Mode> and press **OK** to switch the type of text.

Types of Text That Can Be Entered

Text that can be entered is listed below.

Key	A	a	12
1	@ . - _ /		1
2	ABC	abc	2
3	DEF	def	3
4	GHI	ghi	4
5	JKL	jkl	5
6	MNO	mno	6
7	PQRS	pqrs	7
8	TUV	tuv	8

9	WXYZ	wxyz	9
0	(Not available)		0
#	(space) - . * # ! " ; ; ^ ` _ = / ? \$ @ % & + \ ~ () [] { } < >		(Not available)

NOTE

- Press **#** or select <Symbol> and press **OK** when the type of text that is entered is <A> or <a> to display enterable symbols in the screen. Use **▲** / **▼** / **◀** / **▶** to select the symbol you want to enter, and press **OK**.

Deleting Text

One character is deleted each time **C** is pressed. Press and hold **C** to delete all of the entered text.

Moving the Cursor (Entering a Space)

Press **◀** or **▶** to move the cursor. To enter a space, move the cursor to the end of the text, and press **▶**.

Example of Entering Text and Numbers

Example: "Canon-1"

- 1 Press ***** repeatedly until <A> is selected.
- 2 Press **2** repeatedly until the letter "C" is selected.
- 3 Press ***** repeatedly until <a> is selected.
- 4 Press **2** repeatedly until the letter "a" is selected.
- 5 Press **6** repeatedly until the letter "n" is selected.
- 6 Press **6** repeatedly until the letter "o" is selected.
- 7 Press **6** repeatedly until the letter "n" is selected.
- 8 Press **1** repeatedly until the symbol "-" is selected.
- 9 Press ***** repeatedly until <12> is selected.
- 10 Press **1**.
- 11 Select <Apply> and press **OK**.

Entering Characters Using a USB Keyboard

You can connect a keyboard to the USB port for USB devices on the **▶Back Side(P. 76)** and enter text from the keyboard. Even while the keyboard is connected, you can enter text from the operation panel.

NOTE

- Some keys on the USB keyboard, such as the [Backspace], [Home] and [End] keys, cannot be used. When keys that cannot be used are pressed, nothing is entered or changed.
- To delete text, press the [Delete] key.
- Pressing the [RETURN/ENTER] key completes text entry in the same way as selecting <Apply>.
- You can specify the type of keyboard layout (US layout or UK layout). **▶<English Keyboard Layout>(P. 261)**

- You can disconnect the USB keyboard from the machine at any time. No special operation is required to disconnect it.
- Depending on the display language, you may not be able to enter some characters correctly.
- The USB keyboard may not operate correctly depending on its type.

Logging in to the Machine

7YX2-02C

If Department ID Management is enabled or System Manager IDs are enabled, you must log in before using the machine. When the login screen appears, use the procedure below to enter the Department ID and PIN.

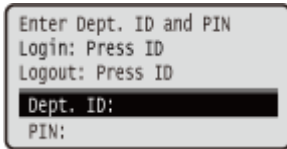

1 Enter the ID.

- 1 Select <Department ID> or <System Manager ID>.
- 2 Enter the ID.
 - If no PIN is registered, proceed to step 3.

2 Enter the PIN.

- 1 Select <PIN>.
- 2 Enter the PIN.

3 Press **ID**.

- ⇒ The login screen will be changed to the Home screen.
 - After you finish using the machine, press **ID** to display the login screen.

LINKS

- 🔗 [Setting the Department ID Management\(P. 175\)](#)
- 🔗 [Setting the System Manager ID and PIN\(P. 173\)](#)

Loading Paper

7YX2-02E

You can load the paper into the paper drawer or multi-purpose tray. Load the paper you usually use into the paper drawer. The paper drawer is convenient when using large amounts of paper. Use the multi-purpose tray when you temporarily use a size or type of paper that is not loaded in the paper drawer. See **▶ Available Paper(P. 379)** for available paper sizes and types.



About Paper

- ▶ **Precautions for Paper(P. 101)**
- ▶ **Storing the Paper Printed with the Machine(P. 102)**

How to Load Paper

- ▶ **Loading Paper in the Paper Drawer(P. 103)**
- ▶ **Loading Paper in the Multi-Purpose Tray(P. 108)**
- ▶ **Loading Envelopes(P. 111)**
- ▶ **Loading Preprinted Paper(P. 113)**

Configuring the Settings for the Loaded Paper

- ▶ **Specifying Paper Size and Type(P. 117)**

Precautions for Paper

IMPORTANT

Do not use the following types of paper:

- A paper jam or printing error may occur.
 - Wrinkled or creased paper
 - Curled or rolled paper
 - Torn paper
 - Damp paper
 - Very thin paper
 - Thin coarse paper
 - Paper printed by a thermal transfer printer
 - Back side of paper printed by a thermal transfer printer
 - Highly textured paper
 - Glossy paper

Notes on use of paper

- Only use paper that has fully acclimatized to the environment in which the machine is installed. Using paper that has been stored under different temperature or humidity conditions may cause paper jams or result in poor print quality.

Paper handling and storage

- It is recommended that you use paper as soon as possible after unwrapping. Paper remaining unused should be covered with the original wrapping paper and stored on a flat surface.
- Keep the paper wrapped in its original package to protect the paper from moisture or dryness.
- Do not store the paper in such a way that may cause it to curl or fold.
- Do not store the paper vertically or do not stack too much paper.
- Do not store the paper in direct sunlight, or in a place subject to high humidity, dryness, or drastic changes in temperature or humidity.

NOTE

When printing on paper that has absorbed moisture

- Steam may emit from the paper output area, or water droplets may form around the paper output area. There is nothing unusual about any of these occurrences, which occur when the heat generated from fixing toner on the paper causes moisture in the paper to evaporate (most likely to occur at low room temperatures).

Storing the Paper Printed with the Machine

When handling/storing the paper printed with the machine, take the following precautions.

■ How to Store the Printed Paper

- Store on a flat surface.
- Do not store together with articles made of PVC (polyvinyl chloride) such as clear folders. Toner may melt, resulting in the paper's sticking to PVC articles.
- Take care that the paper does not get folded or creased. Toner may peel off.
- To store over a long period of time (two years or longer), store in binders or equivalent.
- When the paper is stored over a long period of time, it may become discolored and thus the print may seem to have undergone a change of color.
- Do not store in a place where the temperature is high.

■ Precautions When Applying Adhesive

- Always use insoluble adhesive.
- Before applying adhesive, perform a test using a printout no longer required.
- When putting adhesive-applied paper sheets one over another, make sure that the adhesive is completely dried out.

LINKS

- [Registering a Custom Paper Size\(P. 124\)](#)

Loading Paper in the Paper Drawer

Load the paper that you usually use in the paper drawer. When you want to print on paper that is not loaded in the paper drawer, load the paper in the multi-purpose tray. **▶ Loading Paper in the Multi-Purpose Tray(P. 108)**

▶ Loading Regular Size Paper(P. 103)

▶ Loading Custom Size Paper(P. 105)

! IMPORTANT

- When loading A5 size paper in the paper drawer of the main unit, see **▶ Loading Custom Size Paper(P. 105)** .
- When you want to load A5 size paper in the optional cassette feeding module in the landscape orientation, see **▶ Loading Regular Size Paper(P. 103)** . If you want to use the portrait orientation, load paper by following the procedure for **▶ Loading Custom Size Paper(P. 105)** .
- When using A6 size paper, see **▶ Loading Custom Size Paper(P. 105)** and load it in the portrait orientation.

Landscape orientation

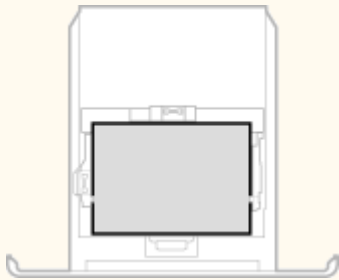

Portrait orientation

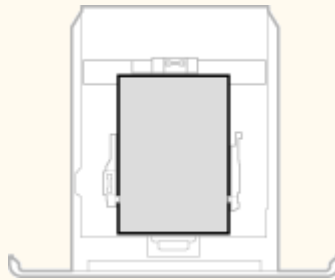

NOTE

- Follow the procedure below when loading paper into the optional cassette feeding module.

Loading Regular Size Paper

To load paper whose size is found in the paper size markings on the paper drawer, use the following procedure. For paper whose size is not found in the paper size markings, see **▶ Loading Custom Size Paper(P. 105)** .

1 Pull out the paper drawer.

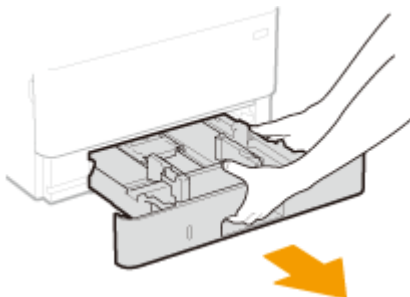

! IMPORTANT:

- Make sure to hold the paper drawer with both hands, and pull it out gently. Otherwise, you may damage the paper drawer by dropping it, if it slides out too easily.

2 Adjust the positions of the paper guides to the paper size you want to use.

- While pressing the lock release lever, move the paper guide to align the projection to the appropriate paper size marking.

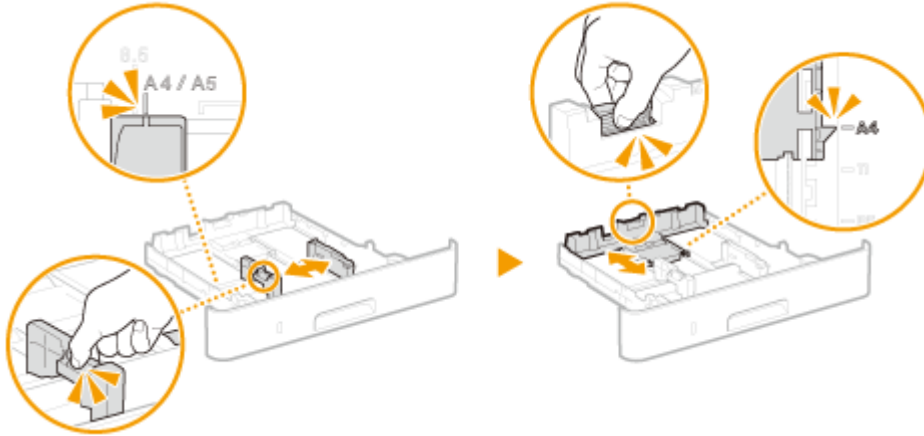

3 Load the paper so that the edge of the paper stack is aligned against the paper guide on the rear side of the paper drawer.

- Load the paper with the print side face down.
- Fan the paper stack well, and tap it on a flat surface to align the edges of the paper stack.



! IMPORTANT:

Do not exceed the load limit line when loading paper

- Make sure that the paper stack does not exceed the load limit line (a). Loading too much paper can cause paper jams.

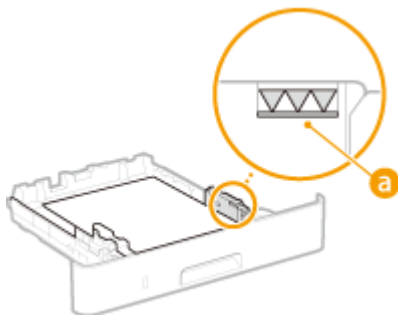

NOTE:

- When loading paper with a logo, see **Loading Preprinted Paper(P. 113)** .

4 Insert the paper drawer into the machine.

- When you insert the paper drawer with <Notify to Check Paper Settings> set to <On>, a confirmation screen is displayed. **<Notify to Check Paper Settings>(P. 332)**

» Continue to [▶ Specifying Paper Size and Type in the Paper Drawer\(P. 118\)](#)

! IMPORTANT:

When changing the paper size or type

- The factory default settings for paper size and type are <A4> and <Plain 2>, respectively. If you load a different size or type of paper into the machine, make sure to change the settings. If you do not change the settings, the machine cannot print properly.

Printing on the Back Side of Printed Paper (Manual 2-Sided Printing)

- You can print on the back side of printed paper. Flatten any curls on the printed paper and insert it into the paper drawer with the print side face down or into the multi-purpose tray ([▶ Loading Paper in the Multi-Purpose Tray\(P. 108\)](#)) with the print side face up.
 - When using the multi-purpose tray, load one sheet of paper each time you print.
 - You can use only the paper printed with this machine.
 - You cannot print on the side that has previously been printed on.
 - If the printouts look faded, set the target paper source to <On> in <Manual Back Side Print (2-Sided Only)>. [▶<Manual Back Side Print \(2-Sided Only\)>\(P. 288\)](#)
 - If you are using A5 size paper, the reverse side may not be printed correctly.

Loading Custom Size Paper

To load custom size paper or other paper whose size is not found in the paper size markings on the paper drawer, use the following procedure.

1 Pull out the paper drawer.

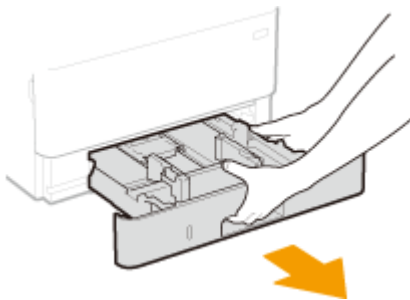

! IMPORTANT:

- Make sure to hold the paper drawer with both hands, and pull it out gently. Otherwise, you may damage the paper drawer by dropping it, if it slides out too easily.

2 Spread the paper guides apart.

- Press the lock release lever to slide the paper guides outward.

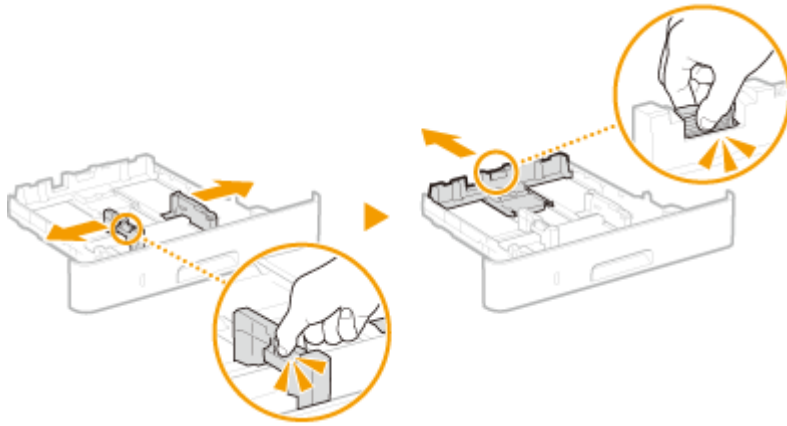

3 Load the paper so that the edge of the paper stack is aligned against the front side of the paper drawer.

- Load the paper with the print side face down.
- Fan the paper stack well, and tap it on a flat surface to align the edges of the paper stack.



! IMPORTANT:

Do not exceed the load limit line when loading paper

- Make sure that the paper stack does not exceed the load limit line (a). Loading too much paper can cause paper jams.

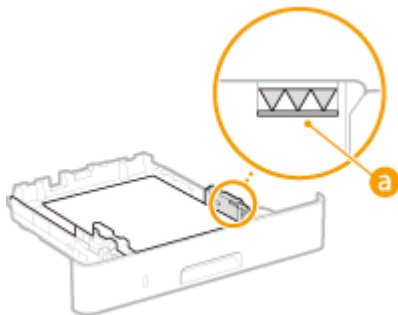

NOTE:

- When loading paper with a logo, see [Loading Preprinted Paper\(P. 113\)](#) .

4 Align the paper guides against the edges of the paper.

- Press the lock release lever and slide the paper guides inward until they are aligned securely against the edges of the paper.

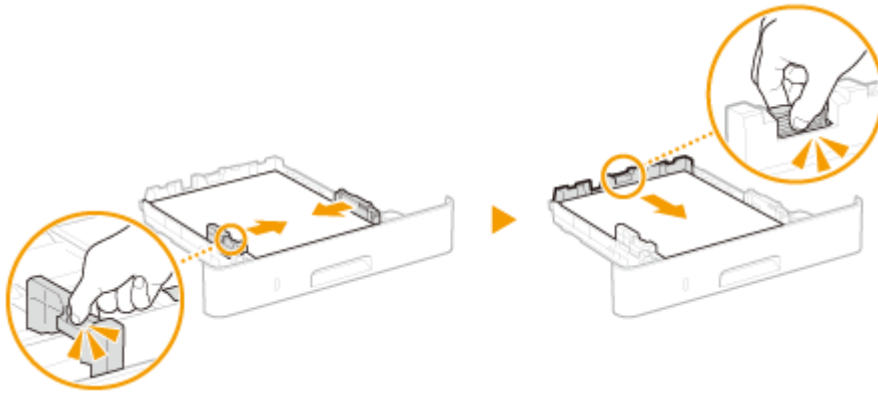

! IMPORTANT:

Align the paper guides securely against the edges of the paper

- Paper guides that are too loose or too tight can cause misfeeds or paper jams.

5 Insert the paper drawer into the machine.

- When you insert the paper drawer with <Notify to Check Paper Settings> set to <On>, a confirmation screen is displayed. [▶<Notify to Check Paper Settings>\(P. 332\)](#)

» Continue to [▶Specifying Paper Size and Type in the Paper Drawer\(P. 118\)](#)

! IMPORTANT:

When changing the paper size or type

- The factory default settings for paper size and type are <A4> and <Plain 2>, respectively. If you load a different size or type of paper into the machine, make sure to change the settings. If you do not change the settings, the machine cannot print properly.

Printing on the Back Side of Printed Paper (Manual 2-Sided Printing)

- You can print on the back side of printed paper. Flatten any curls on the printed paper and insert it into the paper drawer with the print side face down or into the multi-purpose tray ([▶Loading Paper in the Multi-Purpose Tray\(P. 108\)](#)) with the print side face up.
 - When using the multi-purpose tray, load one sheet of paper each time you print.
 - You can use only the paper printed with this machine.
 - You cannot print on the side that has previously been printed on.
 - If the printouts look faded, set the target paper source to <On> in <Manual Back Side Print (2-Sided Only)>. [▶<Manual Back Side Print \(2-Sided Only\)>\(P. 288\)](#)
 - If you are using A5 size paper, the reverse side may not be printed correctly.

LINKS

- [▶Available Paper\(P. 379\)](#)

Loading Paper in the Multi-Purpose Tray

7YX2-02H

When you want to print on paper that is not loaded in the paper drawer, load the paper in the multi-purpose tray. Load the paper that you usually use in the paper drawer. **▶ Loading Paper in the Paper Drawer(P. 103)**

! IMPORTANT

Make sure to insert the paper drawer

- The machine only prints when the paper drawer is inserted, even if paper is loaded in the multi-purpose tray. An error message is displayed if you attempt to print without inserting the paper drawer.

NOTE

When loading A5/A6 size paper

- When setting the paper size, make sure the current paper orientation. **▶ Specifying Paper Size and Type in the Multi-Purpose Tray(P. 120)**
- When using A6 size paper, load it in the portrait orientation.

Landscape orientation



Portrait orientation



1 Open the cover.

- Hold the left and right side handles, and open the cover.



2 Pull out the paper tray and the tray extension.

- Pull out the tray extension when loading large paper.



3 Spread the paper guides apart.

- Press the lock release lever to slide the paper guides outward.

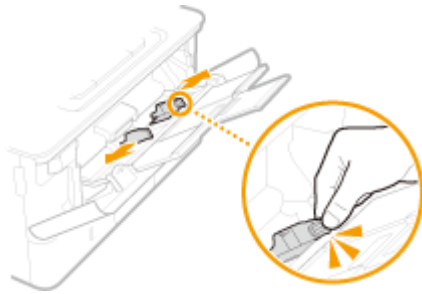

4 Insert the paper into the multi-purpose tray until the paper stops.

- Load the paper with the print side face up.
- Fan the paper stack well, and tap it on a flat surface to align the edges of the paper stack.

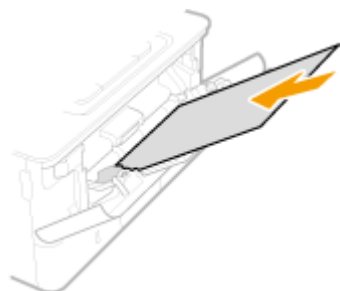

! IMPORTANT:

Do not exceed the load limit guide when loading paper

- Make sure that the paper stack does not exceed the load limit guide (a). Loading too much paper can cause paper jams.

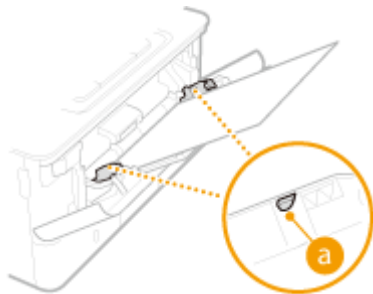

NOTE:

- When loading envelopes or paper with a logo, see ▶ Loading Envelopes(P. 111) or ▶ Loading Preprinted Paper(P. 113) .

5 Align the paper guides against the edges of the paper.

- Press the lock release lever and slide the paper guides inward until they are aligned securely against the edges of the paper.

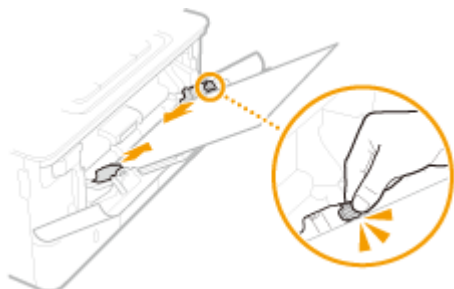

! IMPORTANT:

Align the paper guides securely against the edges of the paper

- Paper guides that are too loose or too tight can cause misfeeds or paper jams.

» Continue to [▶ Specifying Paper Size and Type in the Multi-Purpose Tray\(P. 120\)](#)

Printing on the Back Side of Printed Paper (Manual 2-Sided Printing)

- You can print on the back side of printed paper. Flatten any curls on the printed paper and insert it into the paper drawer ([▶ Loading Paper in the Paper Drawer\(P. 103\)](#)) with the print side face down or into the multi-purpose tray with the print side face up.
 - When using the multi-purpose tray, load one sheet of paper each time you print.
 - You can use only the paper printed with this machine.
 - You cannot print on the side that has previously been printed on.
 - If the printouts look faded, set the target paper source to <On> in <Manual Back Side Print (2-Sided Only)>.
 - ▶<Manual Back Side Print (2-Sided Only)>(P. 288)
 - If you are using A5 size paper, the reverse side may not be printed correctly.

LINKS

▶ Available Paper(P. 379)

Loading Envelopes

7YX2-02J

Make sure to flatten any curls on envelopes before loading them. Also pay attention to the orientation of envelopes and which side is face up. You cannot load envelopes in the paper drawer.

◉ **Before Loading Envelopes(P. 111)**

◉ **In the Multi-Purpose Tray(P. 112)**

NOTE

- This section describes how to load envelopes in the orientation you want, as well as procedures that you need to complete before loading envelopes. For a description of the general procedure for loading envelopes in the multi-purpose tray, see ◉ **Loading Paper in the Multi-Purpose Tray(P. 108)** .

Before Loading Envelopes

Follow the procedure below to prepare the envelopes before loading.

1 Close the flap of each envelope.



2 Flatten them to release any remaining air, and make sure that the edges are pressed tightly.



3 Loosen any stiff corners of the envelopes and flatten any curls.

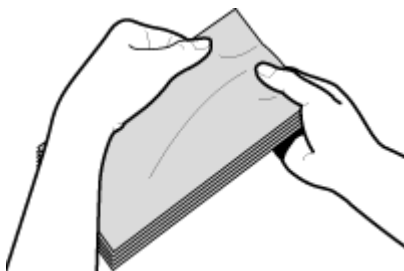

4 Align the edges of the envelopes on a flat surface.

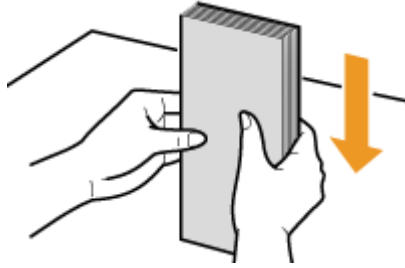

In the Multi-Purpose Tray

Load the envelopes Monarch, COM10, DL, or ISO-C5 in portrait orientation (with the short edge toward the machine), with the non-glued side (front side) face up. You cannot print on the reverse side of envelopes.

NOTE

- Load the envelopes so that the edge with the flap is toward the left side as shown in the illustration.

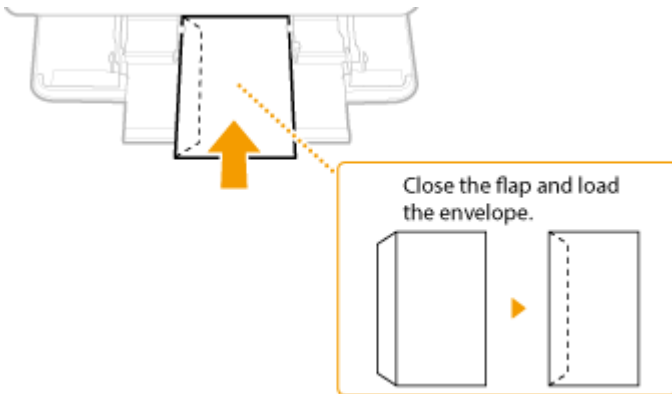

Loading Preprinted Paper

7YX2-02K

When you use paper that has been preprinted with a logo, pay attention to the orientation of the paper when loading. Load the paper properly so that printing is performed on the correct side of the paper with a logo.



▶ **Making 1-Sided Printouts on Paper with Logos(P. 113)**

▶ **Making 2-Sided Printouts on Paper with Logos(P. 115)**

NOTE

- This section mainly describes how to load preprinted paper with the proper facing and orientation. For a description of the general procedure for loading paper in the paper drawer or multi-purpose tray, see ▶ **Loading Paper in the Paper Drawer(P. 103)** or ▶ **Loading Paper in the Multi-Purpose Tray(P. 108)** .

Making 1-Sided Printouts on Paper with Logos

Printing on Paper with Logos in Portrait Orientation



When loading paper in the paper drawer

Load the paper with the logo side (the side to print the document) face down.

Loading Orientation

Portrait



Landscape (A5)

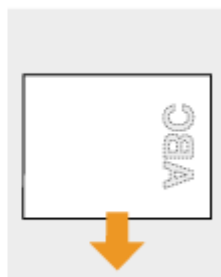

When loading paper in the multi-purpose tray

Load the paper with the logo side (the side to print the document) face up.

Loading Orientation

Portrait

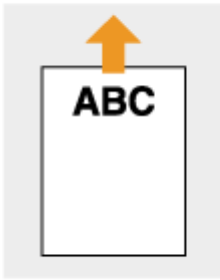

Landscape (A5)

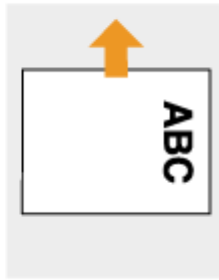

Printing on Paper with Logos in Landscape Orientation

Preprinted Paper

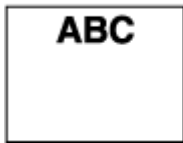

+

Document



→

Print Result



When loading paper in the paper drawer

Load the paper with the logo side (the side to print the document) face down.

Loading Orientation

Portrait



Landscape (A5)



When loading paper in the multi-purpose tray

Load the paper with the logo side (the side to print the document) face up.

Loading Orientation

Portrait

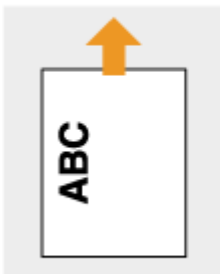

Landscape (A5)

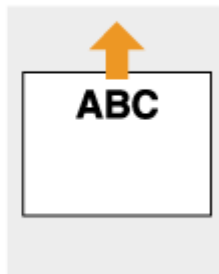

Making 2-Sided Printouts on Paper with Logos

Printing on Paper with Logos in Portrait Orientation

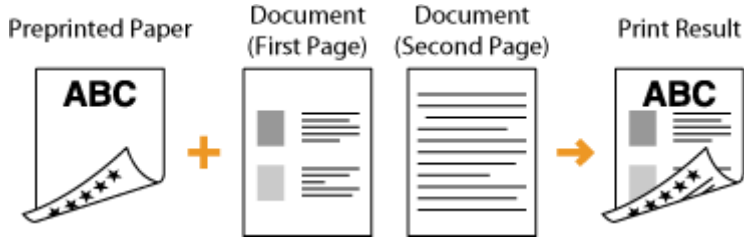

When loading paper in the paper drawer

Load the paper with the front logo side (the side to print the first page of the document) face up.

Loading Orientation

Portrait



Landscape (A5)

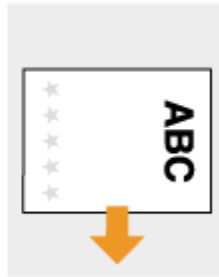

When loading paper in the multi-purpose tray

Load the paper with the front logo side (the side to print the first page of the document) face down.

Loading Orientation

Portrait



Landscape (A5)



Printing on Paper with Logos in Landscape Orientation

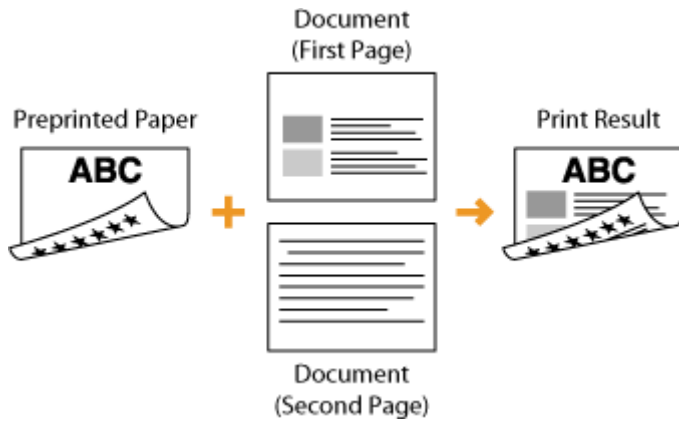

When loading paper in the paper drawer

Load the paper with the front logo side (the side to print the first page of the document) face up.

Loading Orientation

Portrait



Landscape (A5)



When loading paper in the multi-purpose tray

Load the paper with the front logo side (the side to print the first page of the document) face down.

Loading Orientation

Portrait



Landscape (A5)



NOTE

The <Switch Paper Feed Method> setting

- When you print on preprinted paper, you need to change the facing of the paper to load each time you perform 1-sided and 2-sided printing. However, if <Switch Paper Feed Method> is set to <Print Side Priority>, the facing that you use for loading preprinted paper for 2-sided printing can also be used for 1-sided printing. This setting is especially useful if you frequently perform both 1-sided and 2-sided printing. ▶ <Switch Paper Feed Method>(P. 298)

Specifying Paper Size and Type

7YX2-02L

You must specify the paper size and type settings to match the paper that is loaded. Make sure to change the paper settings when you load the paper that is different from the previously loaded paper.

- ▶ **Specifying Paper Size and Type in the Paper Drawer(P. 118)**
- ▶ **Specifying Paper Size and Type in the Multi-Purpose Tray(P. 120)**
- ▶ **Registering Default Paper Settings for the Multi-Purpose Tray(P. 122)**
- ▶ **Registering a Custom Paper Size(P. 124)**
- ▶ **Limiting the Paper Sizes Displayed(P. 126)**
- ▶ **Automatically Selecting an Appropriate Paper Source for Each Function(P. 127)**

IMPORTANT

- If the setting does not match the size and type of loaded paper, a paper jam or printing error may occur.

Specifying Paper Size and Type in the Paper Drawer

7YX2-02R

1 Select <Paper Settings> in the Home screen.  Home Screen(P. 91)

2 Select the target paper drawer.

- When the optional cassette feeding module is installed, its paper drawer is also displayed.

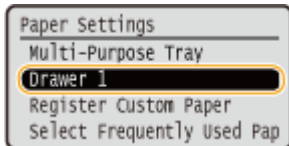

3 Select the paper size.

- If the loaded paper size is not displayed, select <Other Sizes>.

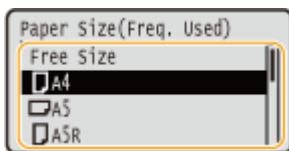

NOTE:

When loading A5 size paper

- In the landscape orientation, select <A5>. In the portrait orientation, select <A5R>.

Landscape orientation

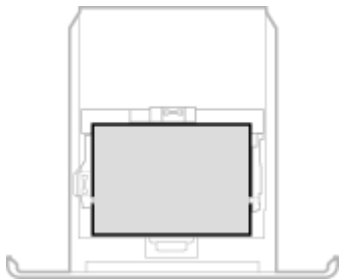

Portrait orientation



About <Free Size>

- If you frequently need to change the paper to be loaded, set to <Free Size>; this will reduce the number of steps required to change the setting each time. You can also display an error message when the setting in the printer driver is significantly different from the size of the loaded paper.  <Action When Free Paper Size Mismatch>(P. 300)

4 Select the paper type.

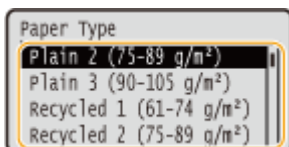

NOTE:

About <Free>

- If you frequently need to change the paper to be loaded, set to <Free>; this will reduce the number of steps required to change the setting each time. However, take note that this setting lets the machine perform printing even if there is mismatch between the paper type setting in the printer driver and the paper type actually loaded in the machine.
- When the paper type setting in the printer driver is [Auto], the machine operates the same way as when the paper type is [Plain 1].

LINKS

- ▶ **Loading Paper in the Paper Drawer(P. 103)**
- ▶ **Limiting the Paper Sizes Displayed(P. 126)**
- ▶ **Available Paper(P. 379)**
- ▶ **<Notify to Check Paper Settings>(P. 332)**

Specifying Paper Size and Type in the Multi-Purpose Tray

7YX2-02S

The screen shown here is displayed when paper is loaded in the multi-purpose tray. Follow the on-screen instructions to specify settings that match the size and type of the loaded paper.

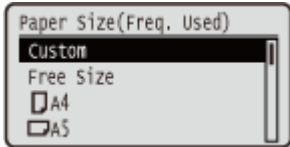

NOTE

If the screen shown above is not displayed when paper is loaded



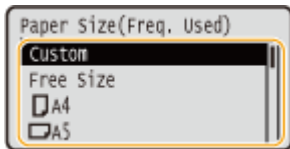

- If you always load the same paper in the multi-purpose tray, you can skip the paper setting operations by registering the paper size and type as the default setting. When the default setting is registered, however, the screen shown above is not displayed. To display the screen, select <Specify When Loading Paper> ( **Registering Default Paper Settings for the Multi-Purpose Tray(P. 122)**).

1 Select the paper size.

- If the loaded paper size is not displayed, select <Other Sizes>.



■When loading custom size paper

- Select <Custom>.
- Specify the length of the <X> side and <Y> side.
 - Execute the following steps in sequence: <X>  enter the paper width   <Y>  enter the paper length 



- Select <Apply>.

NOTE:

About <Free Size>

- If you frequently need to change the paper to be loaded, set to <Free Size>; this will reduce the number of steps required to change the setting each time. You can also display an error message when the setting in the printer driver is significantly different from the size of the loaded paper.  **<Action When Free Paper Size Mismatch>(P. 300)**

2 Select the paper type.

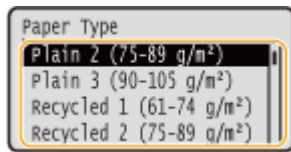

NOTE:

About <Free>

- If you frequently need to change the paper to be loaded, set to <Free>; this will reduce the number of steps required to change the setting each time. However, take note that this setting lets the machine perform printing even if there is mismatch between the paper type setting in the printer driver and the paper type actually loaded in the machine.
- When the paper type setting in the printer driver is [Auto], the machine operates the same way as when the paper type is [Plain 1].

LINKS

- ▶ [Loading Paper in the Multi-Purpose Tray\(P. 108\)](#)
- ▶ [Limiting the Paper Sizes Displayed\(P. 126\)](#)
- ▶ [Available Paper\(P. 379\)](#)

Registering Default Paper Settings for the Multi-Purpose Tray

You can register default paper settings for the multi-purpose tray. Registering default settings can save yourself the effort of having to specify the settings each time you load the same paper into the multi-purpose tray.

NOTE

- After the default paper setting is registered, the paper setting screen is not displayed when paper is loaded, and the same setting is always used. If you load a different paper size or type without changing the paper settings, the machine may not print properly. To avoid this problem, select <Specify When Loading Paper> in step 3, and then load the paper.

1 Select <Paper Settings> in the Home screen.  Home Screen(P. 91)

2 Select multi-purpose tray.

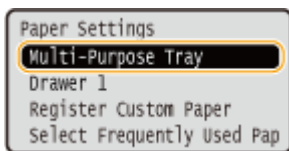

3 Select the paper size.

- If the loaded paper size is not displayed, select <Other Sizes>.

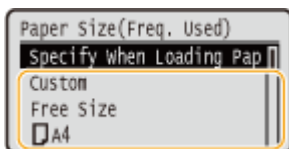

■ Registering a custom paper size

1 Select <Custom>.

2 Specify the length of the <X> side and <Y> side.

- Execute the following steps in sequence: <X> ► enter the paper width ►  ► <Y> ► enter the paper length ► 



3 Select <Apply>.

NOTE:

About <Free Size>

- If you frequently need to change the paper to be loaded, set to <Free Size>; this will reduce the number of steps required to change the setting each time. You can also display an error message when the setting in the printer driver is significantly different from the size of the loaded paper. **▶<Action When Free Paper Size Mismatch>(P. 300)**

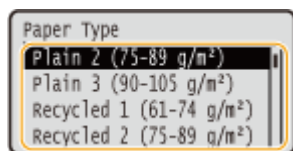
4 Select the paper type.**NOTE:****About <Free>**

- If you frequently need to change the paper to be loaded, set to <Free>; this will reduce the number of steps required to change the setting each time. However, take note that this setting lets the machine perform printing even if there is mismatch between the paper type setting in the printer driver and the paper type actually loaded in the machine.
- When the paper type setting in the printer driver is [Auto], the machine operates the same way as when the paper type is [Plain 1].

LINKS

- ▶ **Loading Paper in the Multi-Purpose Tray(P. 108)**
- ▶ **Limiting the Paper Sizes Displayed(P. 126)**
- ▶ **Available Paper(P. 379)**

Registering a Custom Paper Size

7YX2-02W

You can register up to three frequently used custom paper sizes.

1 Select <Paper Settings> in the Home screen. ▶ Home Screen(P. 91)

2 Select <Register Custom Paper>.

3 Select the registration number.

- If you have selected the registered number, continue on to select <Edit>.

NOTE:

Deleting a setting

- Select the registered number, and then select <Delete> ▶ <Yes>.

4 Specify the length of the <X> side and <Y> side.

- Execute the following steps in sequence: <X> ▶ enter the paper width ▶ **OK** ▶ <Y> ▶ enter the paper length ▶ **OK**

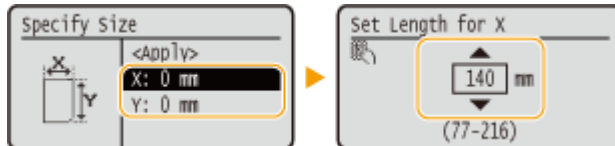

5 Select <Apply>.

6 Select the paper type.

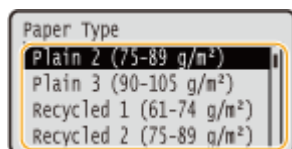

NOTE:

About <Free>

- If you frequently need to change the paper to be loaded, set to <Free>; this will reduce the number of steps required to change the setting each time. However, take note that this setting lets the machine perform printing even if there is mismatch between the paper type setting in the printer driver and the paper type actually loaded in the machine.
- When the paper type setting in the printer driver is [Auto], the machine operates the same way as when the paper type is [Plain 1].

Setting to the registered custom size

The paper sizes that are registered in the procedure above are displayed on the paper size selection screen for the paper drawer or multi-purpose tray.

Example for multi-purpose tray:

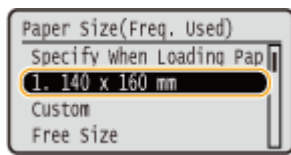

LINKS

- ▶ **Loading Paper in the Paper Drawer(P. 103)**
- ▶ **Loading Paper in the Multi-Purpose Tray(P. 108)**

Limiting the Paper Sizes Displayed

You can ensure that only frequently used paper sizes are shown in the screen for selecting the paper size setting.

- 1** Select **<Paper Settings>** in the Home screen. **▶Home Screen(P. 91)**
- 2** Select **<Select Frequently Used Paper Sizes>**.
- 3** Select the paper source you want to limit the paper sizes to be displayed for.
 - When the optional cassette feeding module is installed, its paper drawer is also displayed.

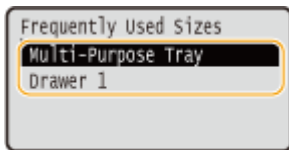

- 4** Clear the check boxes for paper sizes you do not want displayed.

- Ensure that only the check boxes for frequently used paper sizes are selected.

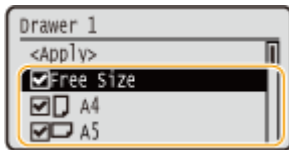

NOTE:

- Paper sizes that are not selected can be viewed by selecting **<Other Sizes>** in the paper size setting selection screen.

- 5** Select **<Apply>**.

LINKS

- ▶ **Specifying Paper Size and Type in the Paper Drawer(P. 118)**
- ▶ **Specifying Paper Size and Type in the Multi-Purpose Tray(P. 120)**
- ▶ **Registering Default Paper Settings for the Multi-Purpose Tray(P. 122)**

Automatically Selecting an Appropriate Paper Source for Each Function

7YX2-02Y

Enable or disable the automatic paper source selection feature for each paper source. If this feature is set to <On>, the machine automatically selects a paper source that is loaded with paper of the appropriate size for each print job. Also, when the paper in the selected paper source runs out, this feature enables continuous printing by switching from that paper source to another that is loaded with the same paper size.

- 1 Select <Menu> in the Home screen. ▶ Home Screen(P. 91)
- 2 Select <Function Settings> ▶ <Common> ▶ <Paper Feed Settings>.
- 3 Select <Drawer Auto Selection On/Off>.
- 4 Select the target function.

- When the target function is report/list printing, select <Other>.

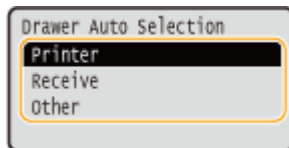

- 5 For each paper source to which you want to apply the automatic paper source selection feature, specify <On>.

- When the optional cassette feeding module is installed, its paper drawer is also displayed.
- Select the target paper source ▶ <On>.

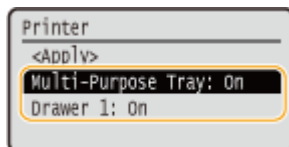

NOTE:

- Always specify <On> for at least one of the paper drawers. If you select <Off> for all the drawers, then you cannot finish the setting procedure.

- 6 Select <Apply>.

Customizing the Display

7YX2-030

In order to make the Home screen easier to use, you can customize it.



Customizing the Home Screen

You can rearrange the displayed items and customize the screen to make it easier to select functions. ▶
Customizing the Home Screen(P. 129)

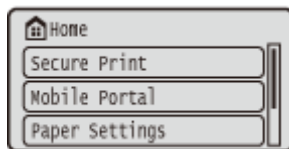

Customizing the Home Screen

7YX2-031

To make the buttons easier to use, you can freely change the item display order.

1 Select <Display Order (Home)> in the Home screen.  Home Screen(P. 91)

2 Use ▲ / ▼ to select the item to be moved, and press .

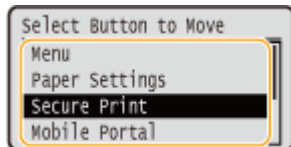

3 Use ▲ / ▼ to move to the target position, and press .

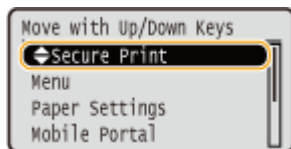

4 When the buttons are rearranged in the way you want, press .

LINKS

 Basic Operation(P. 95)

Setting Sounds

7YX2-032

The machine produces sounds in a variety of situations, such as when a paper jam or error occurs. You can set the volume of each of these sounds individually.

1 Select <Menu> ▶ <Preferences> ▶ <Volume Settings>.

2 Select a setting.

Setting	Description	Action
<Entry Tone>	Confirmation sound each time a key on the operation panel or button on the display is pressed	Select <On> (produce a tone) or <Off> (not produce a tone).
<Invalid Entry Tone>	Sound produced when an invalid key operation is performed, such as when you enter a number outside the valid setting range	
<Restock Supplies Tone>	Sound produced when a toner cartridge is almost empty	
<Warning Tone>	Sound telling that a trouble has occurred on the machine, such as a paper jam, incorrect operation, or press of an inoperable key	
<Job Done Tone>	Sound produced when an operation such as printing is complete	
<Energy Saver Alert>	Sound produced when the machine enters or exits sleep mode	

Entering Sleep Mode

7YX2-033

The sleep mode function reduces the amount of power consumed by the machine by disabling power flow to the operation panel. If no operations will be performed on the machine for a while, such as during a lunch break, you can save power simply by pressing  on the operation panel.

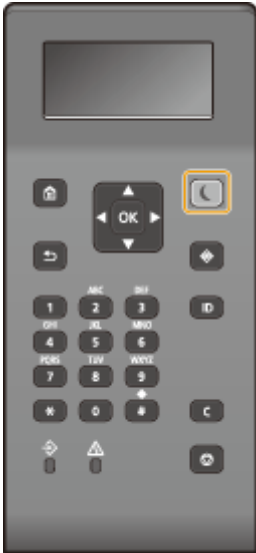

NOTE

When in sleep mode

- When the machine enters sleep mode,  lights up yellow green.



Situations in which the machine does not enter sleep mode

- When the machine is in operation
- When the Data indicator is lit up or blinking
- When the machine is performing an operation such as adjustment or cleaning
- When a paper jam occurs
- When the menu screen is displayed
- When an error message is displayed on the screen (There are some exceptions. The machine sometimes enters sleep mode when an error message is displayed.)
- When the SSID/network key screen for Direct Connection is displayed
- When settings are being imported or exported

Changing the Auto Sleep Time Value

Auto Sleep Time is a function that automatically puts the machine into the sleep mode if it remains idle for a specified length of time. We recommend using the factory default settings ( **<Timer/Energy Settings>(P. 262)**) to reduce power usage. If you want to change the amount of time that elapses before the machine enters the auto sleep mode, perform the procedure below.





<Menu> ► <Preferences> ► <Timer/Energy Settings> ► <Auto Sleep Time> ► Set the amount of time that elapses before the machine automatically enters sleep mode ►  ► 

Changing the Sleep Mode Setting to the Specified Time

You can configure a setting so that the machine is placed into the sleep mode at the specified time. You can also configure a setting so that the sleep mode is released at the specified time.



<Menu> ▶ <Preferences> ▶ <Timer/Energy Settings> ▶ Select <Auto Sleep Daily Timer> or <Sleep Mode Exit Time Settings> ▶ <On> ▶ Enter the time ▶  ▶ 

Exiting Sleep Mode

You can press  or any other key on the operation panel to exit the sleep mode.

Using a USB Memory Device

7YX2-034

When using a USB memory, insert it into the USB port on the machine.

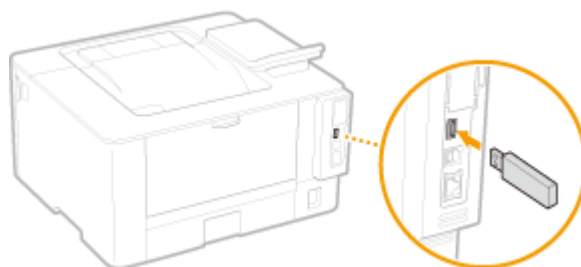

! IMPORTANT

Before using a USB memory device

- The supported formats of USB memory device are FAT16 and FAT32.

The following devices and uses are not supported:

- USB memory devices that have security functions installed
- USB memory devices that do not meet the USB standards
- Memory card readers connected via USB
- USB memory devices that are used with extension cables
- USB memory devices used via a USB hub

Handling of USB memory devices

- Make sure that the USB memory device is correctly oriented before inserting it. If you attempt to insert it in incorrect orientation, the memory device and the machine may be damaged.
- Do not remove, bump or otherwise move the USB memory device while data is being imported or exported. Also, do not turn OFF the machine while processing is in progress.
- You may not be able to save data properly on some USB memory devices.

■ Remove the USB Memory Device

! IMPORTANT

- Always use the following procedure when removing USB memory devices. Using other methods to remove USB memory devices may result in damage to the device and the machine.

- 1 Press .
- 2 Select <Device Status>.
- 3 Select <Remove Memory Media>.
 - ▢ Wait until the <The memory media can be safely removed.> message is displayed.
- 4 Disconnect the USB memory device.

Printing

Printing	135
Printing from a Computer	136
Canceling Prints	138
Checking the Printing Status and Log	140
Various Printing Methods	142
Printing a Document Secured by a PIN (Secure Print)	143
Printing via Secure Print	144
Receiving I-Faxes for Printing	147

Printing

7YX2-035

There are many ways to use the machine as a printer. Make full use of the print functions to suit your needs.

■ Printing from a Computer

You can print a document made on your computer by using the printer driver.

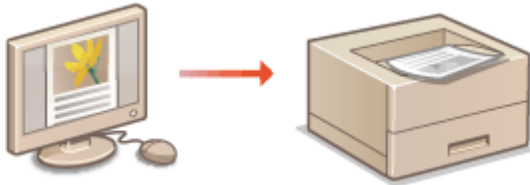

▶ **Printing from a Computer(P. 136)**

■ Useful Functions When Printing

You can assign a PIN to the print data to enhance security.



▶ **Various Printing Methods(P. 142)**

Printing from Mobile Devices

- Linking mobile devices such as smartphones or tablets to this machine provides a quick and easy way to print photos and web pages. ▶ **Linking with Mobile Devices(P. 151)**

Printing from a Computer

7YX2-036

You can print a document made with an application on your computer by using the printer driver. There are useful settings on the printer driver, such as enlarging/reducing and 2-sided printing, that enable you to print your documents in various ways. Before you can use this function, you need to complete some procedures, such as installing the printer driver on your computer. For more information, see the manuals for the relevant drivers on the online manual website.

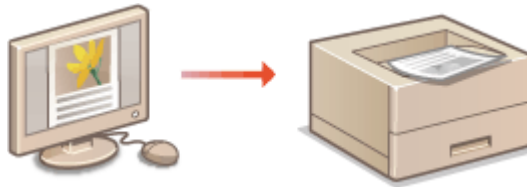

- ▶ **About the Printer Driver Help(P. 136)**
- ▶ **To Use the Optional Items(P. 136)**
- ▶ **Basic Printing Operations(P. 136)**

About the Printer Driver Help

Clicking [Help] on the printer driver screen displays the Help screen. On this screen, you can see the detailed descriptions that are not in the User's Guide.

To Use the Optional Items

If the optional cassette feeding module is attached to the machine after installation of the printer driver, perform the following operation on the printer driver.

! IMPORTANT

- To perform the following procedure, log in to your computer with an administrator account.



Open the printer folder (▶ **Displaying the Printer Folder(P. 398)**) ▶ Right-click the printer driver icon for this machine ▶ [Printer properties] or [Properties] ▶ [Device Settings] tab ▶ [Paper Source] ▶ Select [1-Cassette Feeding Unit] in [Optional Drawer/Cassette] ▶ [OK] ▶ [OK]

Basic Printing Operations

This section describes how to print a document on your computer by using the printer driver.

NOTE

Paper settings on the machine

- Normally, it is necessary to specify the paper size and type for the paper loaded in each paper source before proceeding to printing.

- 1 Open a document in an application and display the print dialog box.
- 2 Select the printer driver for this machine, and click [Preferences] or [Properties].
- 3 Specify the print settings as necessary, and click [OK].
 - Switch the tab according to the settings.

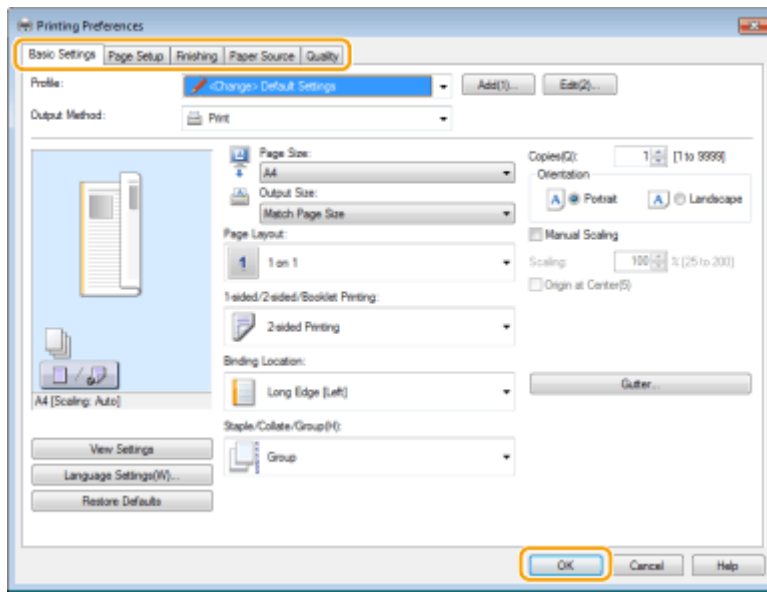

4 Click [Print] or [OK].

⇒ Printing starts.

- If you want to cancel printing, see [▶Canceling Prints\(P. 138\)](#) .

LINKS

- ▶[Checking the Printing Status and Log\(P. 140\)](#)
- ▶[When Printing from the Windows Store App\(P. 404\)](#)

Canceling Prints

7YX2-037

You can cancel printing from your computer or on the operation panel of the machine.

- ▶ **From a Computer(P. 138)**
- ▶ **From the Operation Panel(P. 139)**

From a Computer

You can cancel printing from the printer icon displayed on the system tray on the desktop.

1 Double-click the printer icon.



NOTE:

When the printer icon is not displayed

- Open the printer folder (▶ **Displaying the Printer Folder(P. 398)**), right-click the printer driver icon for this machine, and click [See what's printing] (or double-click the icon of the printer driver for this machine).

2 Select the document you want to cancel, and click [Document] ▶ [Cancel].

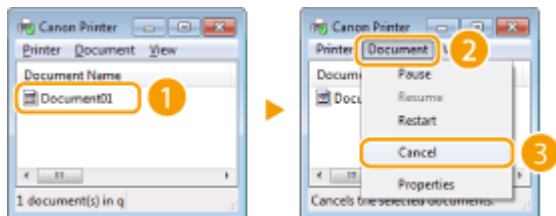

3 Click [Yes].

⇒ Printing of the selected document is canceled.

NOTE

- Several pages may be output after you cancel printing.

TIPS

Canceling from the Remote UI

- You can cancel printing from the [Job Status] page on the Remote UI: ▶ **Checking Current Status of Print Documents(P. 231)**

Canceling from an application

- On some applications, a screen like shown below appears. You can cancel printing by clicking [Cancel].

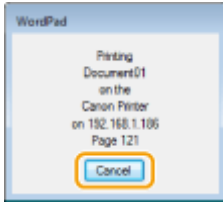

From the Operation Panel

Cancel printing using or .

■ Press to Cancel

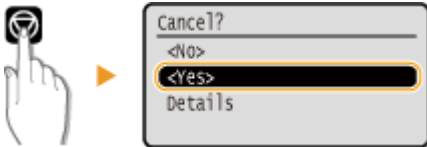

If the Screen Displays a List of Documents When is Pressed

Select the document you want to cancel, and select <Cancel> ► <Yes>.

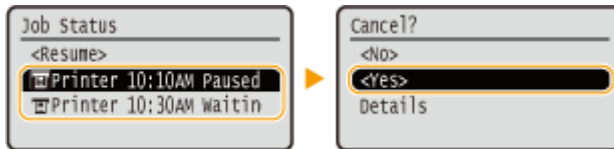

■ Check the Print Job Status Before Canceling



► <Print Job> ► <Job Status> ► Select the document ► <Cancel> ► <<Yes>>

NOTE

- Several pages may be output after you cancel printing.

LINKS

- ▶ [Basic Printing Operations\(P. 136\)](#)
- ▶ [Checking the Printing Status and Log\(P. 140\)](#)

Checking the Printing Status and Log

7YX2-038

You can check the current print statuses and the logs for printed documents.

! IMPORTANT

- When <Display Job Log> is set to <Off>, you cannot check the print logs.  <Display Job Log>(P. 331)

Useful in the Following Cases

- When your documents are not printed for a long time, you may want to see the waiting list of the documents waiting to be printed.
- When you cannot find your printouts that you thought had been printed, you may want to see whether an error has occurred.

1 Press .

2 Select <Print Job>.

3 Check the print statuses and logs.

■ To check the print statuses

- 1** <Job Status> ► Select the document whose status you want to check.

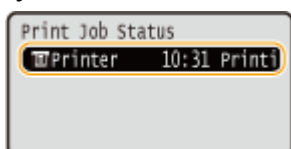

►► Displays detailed information about the document.

■ To check the print logs

- 1** <Job Log> ► Select the document whose log you want to check.
- <OK> is displayed when a document was printed successfully, and <Error> is displayed when a document failed to be printed because it was canceled or there was some error.

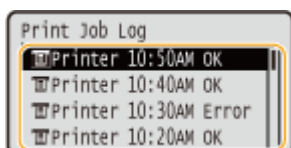

►► Displays detailed information about the document.

- The displayed document name or user name may not reflect the actual document or user name.

NOTE:

When a three-digit number is shown in the case of <Error>

- This number represents an error code. For more information, see "Troubleshooting (FAQ)" on the online manual website.

LINKS

▶ **Basic Printing Operations(P. 136)**

▶ **Canceling Prints(P. 138)**

Various Printing Methods

7YX2-039

This section describes how to print a document by adding a PIN, and how to receive and print I-Faxes.



▶ **Printing a Document Secured by a PIN (Secure Print)(P. 143)**



▶ **Receiving I-Faxes for Printing(P. 147)**

Printing a Document Secured by a PIN (Secure Print)

7YX2-03A

By setting a PIN to a document when printing from a computer, the document is held in the memory of the machine, and is not printed until the correct PIN is entered on the operation panel of the machine. This function is called "Secure Print," and the document that is protected by a PIN is called a "secured document." Using Secure Print keeps printouts of confidential documents from being left unattended.

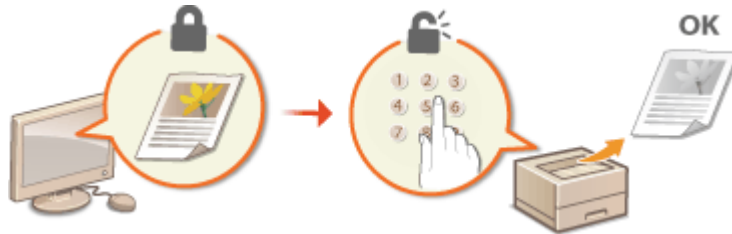

▶ **Printing via Secure Print(P. 144)**

Printing via Secure Print

7YX2-03C

This section describes how to print a document from an application as a secured document. The first part of this section describes how to send a secured document to the machine, and the second part of this section describes how to print the secured document on the machine.

- ▶ **Sending a Secured Document from a Computer to the Machine(P. 144)**
- ▶ **Printing Out Secured Documents(P. 145)**
- ▶ **Changing the Valid Time Period for Secured Documents(P. 145)**

Sending a Secured Document from a Computer to the Machine

- 1** Open a document in an application and display the print dialog box.
- 2** Select the printer driver for this machine, and click [Preferences] or [Properties].
- 3** Select [Secured Print] in [Output Method].
 - ▶▶ The [Information] pop-up screen is displayed. Check the message, and click [Yes] or [No].
- 4** Specify the print settings as necessary, and click [OK].
 - Switch the tab according to the settings.

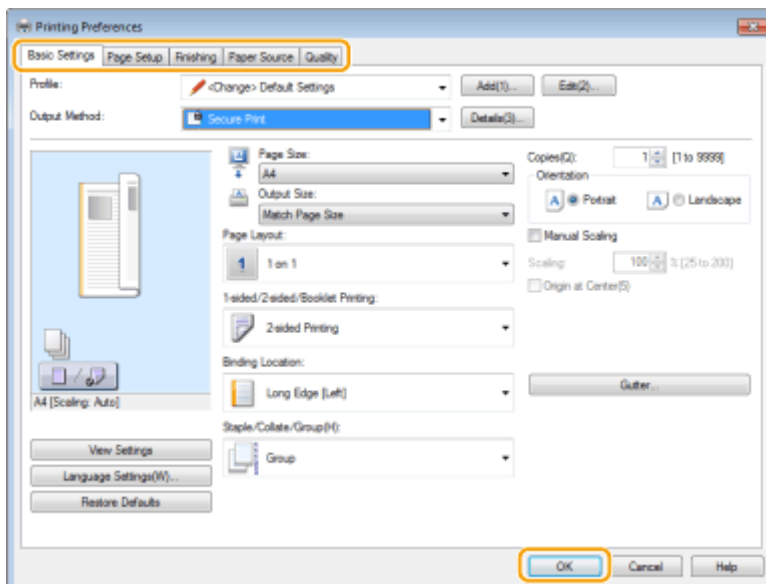

- 5** Click [Print] or [OK].

▶▶ After the secured document is sent to the machine, it is held in the memory of the machine waiting to be printed.

Printing Out Secured Documents

Prints secured documents sent to the machine. After a valid time period ([▶ Changing the Valid Time Period for Secured Documents\(P. 145\)](#)) has elapsed, the secured document will be deleted from the memory of the machine and can no longer be printed.

NOTE

- If secured documents are left unprinted, they occupy the memory and may prevent the machine from printing even ordinary (not secured) documents. Make sure that you print your secured documents as soon as you can.
- You can check how much memory is being used for secured documents.
 ▶ <Device Status> ▶ <Secure Print Memory Usage>

1 Select <Secure Print> in the Home screen. [▶ Home Screen\(P. 91\)](#)

2 Select the secured document to print.

NOTE:

If a screen for user selection is displayed

- If secured documents from two or more users are stored in memory, the screen for user selection is displayed prior to the screen for file selection. Select your user name.

3 Enter the PIN, and press .

⇒ Printing starts.

- If you want to cancel printing, select <Cancel> ▶ <Yes>.

Changing the Valid Time Period for Secured Documents

You can change the valid time period from the time secured document data is sent to the machine until the time it is deleted within a certain period of time.

1 Select <Menu> in the Home screen. [▶ Home Screen\(P. 91\)](#)

2 Select <Function Settings>.

3 Select <Secure Print>.

- If the login screen appears, enter the correct ID and PIN. [▶ Logging in to the Machine\(P. 100\)](#)

4 Select <Secure Print Deletion Time>.

NOTE:

When <Secure Print Deletion Time> cannot be selected

- Set <Use Secure Print> to <On>, restart the machine, and then start the setting procedure again.

Disabling Secure Print

- Set <Use Secure Print> to <Off>, and then restart the machine.

5 Specify how long the machine holds secured documents.

- The secured document is deleted from the memory of the machine unless it is printed before the time specified here elapses.

6 Press .

LINKS

▶ [Checking the Printing Status and Log\(P. 140\)](#)

▶ [Restricting Printing from a Computer\(P. 222\)](#)

Receiving I-Faxes for Printing

7YX2-03E

Internet Fax (I-Fax) is a function that attaches a file to an e-mail as a TIFF image file and transfers it. This machine can receive I-Faxes and print them. I-Faxes can be received automatically at the specified intervals, and also received manually.

- ▶ **Configuring the I-Fax RX Settings(P. 147)**
- ▶ **Receiving I-Faxes Manually(P. 149)**

Configuring the I-Fax RX Settings

Configure the I-Fax RX setting from a computer, and the print settings from the operation panel of this machine.

NOTE

- For more information about the basic operations to be performed when setting the machine from the Remote UI, see ▶ **Setting Up Menu Options from Remote UI(P. 237)** .



From a Computer

- 1 Start the Remote UI and log in to System Manager Mode. ▶ Starting Remote UI(P. 228)**
- 2 Click [Settings/Registration] on the Portal page. ▶ Remote UI Screen(P. 229)**
- 3 Select [Network Settings] ▶ [E-Mail/I-Fax Settings].**
- 4 Click [Edit].**
- 5 Specify the required settings.**

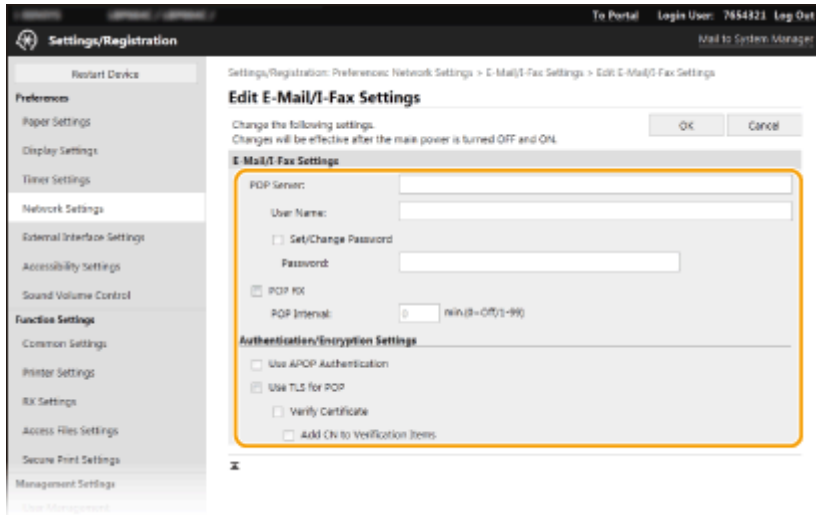

[POP Server]

Enter alphanumeric characters as the POP3 server name or IP address for receiving I-Faxes.

[User Name]

Enter alphanumeric characters as the user name for the specified e-mail account.

[Set/Change Password]

To set or change the password, select the check box and enter alphanumeric characters in [Password].

[POP RX]

Select the check box to receive I-Faxes.

[POP Interval]

This sets the interval (in minutes) used for automatically connecting to the POP3 server. If there are any I-Fax documents on the server, they are automatically received and printed.

NOTE:

To disable automatic reception

- Set [POP Interval] to [0]. When [0] is set, you receive I-Faxes manually. **▶Receiving I-Faxes Manually(P. 149)**

[Use APOP Authentication]

Select the check box to use APOP to encrypt the password during the authentication process.

[Use TLS for POP]

Select the check box to encrypt communication with the POP3 server using TLS. Select the check box for [Verify Certificate] or [Add CN to Verification Items] depending on your needs.

6 Click [OK].

7 Restart the machine. **▶Restarting the Machine(P. 87)**

 From the Operation Panel

8 Specify the print settings as necessary.

■ Specifying the setting for 2-sided printing

- ▶<Print on Both Sides>(P. 325)

■ Specifying the paper size

▶<RX Print Size>(P. 326)

! IMPORTANT

- Depending on the network you are using, you may need to change the POP3 port setting (▶<Changing Port Numbers(P. 192)). For more information, contact your Internet service provider or Network Administrator.

Receiving I-Faxes Manually

If the I-Fax RX setting is completely configured from the POP3 server, you can manually receive I-Faxes and print them. When you want to connect to the server before receiving I-Faxes automatically, or when the machine is configured so that it does not receive I-Faxes automatically, use the method below to receive I-Faxes manually.

1 Press .

2 Select <RX Job>.

3 Select <Check E-Mail RX>.

⇒ Connect to the POP3 server. If there is a document on the server, printing begins.

TIPS

- Printing a Received Document on Both Sides of Paper: ▶<Print on Both Sides>(P. 325)
- Continuing printing even when toner is running low: ▶<Continue Print. When Amount in Cart. Low>(P. 325)

Linking with Mobile Devices

Linking with Mobile Devices	151
Connecting with Mobile Devices	152
Connecting via a Wireless LAN Router (LAN Connection)	153
Connecting Directly (Access Point Mode)	154
Utilizing the Machine through Applications	157
Using AirPrint	160
Printing with AirPrint	164
If AirPrint Cannot Be Used	167
Managing the Machine by the Remote Control	168

Linking with Mobile Devices

7YX2-03F

Linking the machine with mobile devices such as smart phones and tablets enables you to use an appropriate application to perform printing, or other operation with ease. In addition, you can operate the machine from mobile devices via remote control to confirm printing status and change the settings of the machine.



- ▶ **Connecting with Mobile Devices(P. 152)**
- ▶ **Connecting Directly (Access Point Mode)(P. 154)**
- ▶ **Utilizing the Machine through Applications(P. 157)**
- ▶ **Using AirPrint(P. 160)**
- ▶ **Managing the Machine by the Remote Control(P. 168)**

IMPORTANT

- Depending on your mobile device, the machine may not operate correctly.

NOTE

- When [Restrict IPP Port (Port Number: 631)] or [Restrict mDNS Port (Port Number: 5353)] is enabled in Security Policy (▶ **Security Policy(P. 240)**), you can use neither Mopria® or AirPrint.

Connecting with Mobile Devices

7YX2-03H

There are two methods used to connect a mobile device with the machine: connecting via a wireless LAN router, and communicating wirelessly and directly with the machine. Select a connection method in accordance with the communication environment and the device you are using. Perform communication with mobile devices from <Mobile Portal> (▶ **Home Screen(P. 91)**).

■ Connecting via a Wireless LAN Router

Just as connecting a computer to the machine, connect a mobile device to the machine via a wireless LAN router. ▶ **Connecting via a Wireless LAN Router (LAN Connection)(P. 153)**



■ Connecting Directly

Directly connect a mobile device to the machine wirelessly without using wireless LAN. It is possible to immediately connect to the machine wirelessly even outside of a wireless LAN environment. ▶ **Connecting Directly (Access Point Mode)(P. 154)**



Connecting via a Wireless LAN Router (LAN Connection)

7YX2-03J

If a wireless LAN router is connected to the network connected to the machine, you can establish a communication with a mobile device via the wireless LAN router in the same way for a computer. For information about how to connect a mobile device to your wireless LAN router, see the instruction manuals for your networking devices or contact your manufacturer. Connect the machine to a router via the wired or wireless LAN. **▶Setting Up the Network Environment(P. 11)**



NOTE

- To perform the procedures below, use the IPv4 address. **▶Setting IPv4 Address(P. 28)**
- Select <LAN Connection> and proceed with the procedure, if the Direct Connection screen is displayed after <Mobile Portal> is selected in the procedure below.
- For information about the operating systems compatible with Canon PRINT Business, the detailed setting procedure, and the operating procedure, please see the application's Help or the Canon website (<https://global.canon/gomp/>).

- 1** Select <Mobile Portal> in the Home screen. **▶Home Screen(P. 91)**
- 2** Select <Display Device Name/IP Address>.
- 3** Connect from the mobile device to the IP address that appears on the screen.

Connecting Directly (Access Point Mode)

7YX2-03K

Even in an environment without a wireless LAN router, using "Access Point Mode," which can directly connect a mobile device to the machine wirelessly, enables you to connect the mobile device on hand to the machine without difficult settings.



▶ **Preparing for Direct Connection (Access Point Mode)(P. 154)**

▶ **Connecting Directly(P. 155)**

Preparing for Direct Connection (Access Point Mode)

Establish a connection by using Access Point Mode in the following order.

1



Check the network settings of the machine.

- Set the IPv4 address. ▶ **Setting IPv4 Address(P. 28)**



2



Preparing the mobile device

- Configure settings to connect the mobile device to Wi-Fi.



3



Put the machine into the connection standby status.

- <Menu> ▶ <Preferences> ▶ <Network> ▶ <Direct Connection Settings> ▶ set <Use Direct Connection> to <On>.

NOTE

Specifying the value for time until auto termination

- You can specify the time to automatically establish a disconnection when the direct connection is enabled. ▶ **<Time Until Direct Connection Termination>(P. 269)**

Connecting multiple mobile devices at the same time

- Configure the machine's SSID and network key arbitrarily. ▶ **<Access Point Mode Settings>(P. 269)**

Canon PRINT Business

- For information about the operating systems compatible with Canon PRINT Business, the detailed setting procedure, and the operating procedure, please see the application's Help or the Canon website (<https://global.canon/gomp/>).

Connecting Directly

! IMPORTANT

- It may take time until a connection of the machine and the mobile device is established.

1 Select <Mobile Portal> in the Home screen. ▶ Home Screen(P. 91)

- When any mobile device is already connected, press **OK**, and proceed to step 3.

2 Select <Connect>.

3 Select <Display SSID/Network Key>.

4 Configure the Wi-Fi settings from the mobile device using the SSID and network key information that appear on the display.

5 When the target operation is completed, press **OK**, then select <Disconnect> ▶ <Yes>.

TIPS

- Select <Connection Information> on the screen under the direct connection to check the connected mobile device.
- When <Keep Enabled If SSID/Ntwk Key Spcfd> is set to <On>, it is not necessary to perform the operation of selecting <Connect>. ▶ <Keep Enabled If SSID/Ntwk Key Spcfd>(P. 269)

! IMPORTANT

- While connecting via direct connection, you may not be able to connect to the Internet depending on the mobile device you are using.
- If a wireless connection from the mobile device is not performed within 5 minutes while the SSID and network key are displayed, the connection waiting state terminates.
- If the status without data transmission between the mobile device and the machine continues during communication by direct connection, the communication may end.
- Power saving performance of sleep mode degrades while connecting via direct connection.
- If the machine is used with a wireless LAN, you need to keep the machine connected to the wireless LAN when using direct connection. When the machine is not connected to a wireless LAN or the connection

process is not complete yet, the direct connection process cannot begin. If the connection between the machine and the wireless LAN is lost during communication through direct connection, the communication may end.

- When you finish the desired operation, be sure to terminate the connection between the machine and the mobile device. If they remain connected, power saving performance of sleep mode degrades.
- If you use the direct connection, do not set the IP address manually on the mobile device. Doing so may prevent proper communication after using the direct connection.

Utilizing the Machine through Applications

7YX2-03L

Perform printing and other operations from the mobile device connected to the machine using applications. Various applications including those exclusive to Canon are supported. Use properly in accordance with your device, the application, and the situation.

■ Using Canon PRINT Business

This application is used to perform printing and other operations from mobile devices that support iOS/Android. When printing, it is not necessary to perform operations on the machine. For more information on supported operating systems, detailed setting methods, and operations, see the application's Help or the Canon website (<https://global.canon/gomp/>).

IMPORTANT

- You can download Canon PRINT Business for free, but you will be charged the Internet connection fee.

■ Printing with Canon Print Service

You can easily print from the menu of applications that support the Android print subsystem. For more information on supported operating systems and detailed settings and procedures, see the Canon website (<https://global.canon/>).







■ Using Mopria®

The machine also supports Mopria®. Mopria® enables you to perform printing and other operations from a mobile Android device using common operations and settings regardless of the manufacturer or model. For example, businesses using multiple Mopria® compatible devices from different manufacturers can print from the same printer and businesspeople on-the-go can use a Mopria® compatible device with a local certified printer without having to install a separate application. For more information on supporting models or operation environments, see <http://www.mopria.org>.



Confirming Mopria® Settings



Log in to the Remote UI with Administrator privileges ( **Starting Remote UI(P. 228)**)  [Settings/Registration]  [Network Settings]  [Mopria Settings]  [Edit]  Check that the [Use Mopria] check box is selected  [OK]

IMPORTANT

If you enable the Mopria® setting, the following settings in <Network> are set to <On>.

- Use HTTP
- IPP Print Settings
- IPv4Use mDNS
- IPv6Use mDNS

■ Printing from Chrome OS

You can perform printing from Chrome OS without downloading a dedicated application or installing a driver. To print with the machine, it is necessary to enable Mopria®.

Confirming Mopria® Settings



Log in to the Remote UI with Administrator privileges (▶ **Starting Remote UI(P. 228)**) ▶ [Settings/Registration] ▶ [Network Settings] ▶ [Mopria Settings] ▶ [Edit] ▶ Check that the [Use Mopria] check box is selected ▶ [OK]

! IMPORTANT

If you enable the Mopria® setting, the following settings in <Network> are set to <On>.

- Use HTTP
- IPP Print Settings
- IPv4Use mDNS
- IPv6Use mDNS

Printing

1 Before printing, make sure that the machine is turned ON and connected to a Chromebook.

- For information on checking the connection status, see ▶ **Setting Up the Network Environment(P. 11)** .
- See the Chromebook Help page (<https://support.google.com/chromebook/answer/7225252>) for more information on printing.

NOTE

- You can also connect the machine to a Chromebook using a USB cable. See the Chromebook website (<https://support.google.com/chromebook/answer/7225252>) for information on the connection procedure.

 **IMPORTANT**

- Printing from Chrome OS may not be supported, depending on your country or region.

Using AirPrint

This section describes the settings required to use AirPrint and the procedures to be performed using Apple devices.

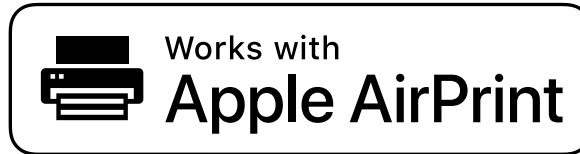

AirPrint Settings

- ▶ [Configuring AirPrint Settings\(P. 160\)](#)
- ▶ [Displaying the Screen for AirPrint\(P. 162\)](#)

Functions of the AirPrint

- ▶ [Printing with AirPrint\(P. 164\)](#)

Troubleshooting

- ▶ [If AirPrint Cannot Be Used\(P. 167\)](#)

Configuring AirPrint Settings

You can register information, including the name of the machine and installation location, that is used for identifying the machine. You can also disable the AirPrint function of the machine. Use the Remote UI to change these settings.

NOTE

- For more information about the basic operations to be performed when setting the machine from the Remote UI, see ▶ [Setting Up Menu Options from Remote UI\(P. 237\)](#) .

- 1** Start the Remote UI and log in to System Manager Mode. ▶ [Starting Remote UI\(P. 228\)](#)
- 2** Click [Settings/Registration] on the Portal page. ▶ [Remote UI Screen\(P. 229\)](#)
 - If you are using a mobile device, such as an iPad, iPhone, or iPod touch, read "click" as "tap" in this section.
- 3** Select [Network Settings] ▶ [AirPrint Settings].
- 4** Click [Edit].

5 Specify the required settings.

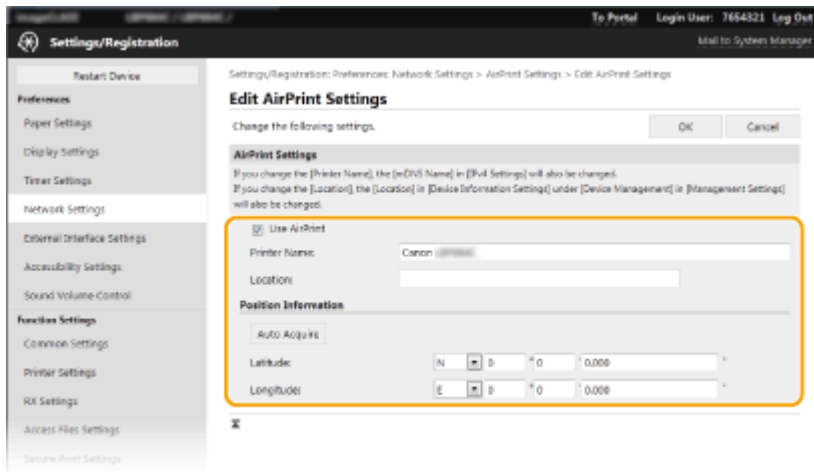

[Use AirPrint]

Select the check box to enable AirPrint. To disable AirPrint, clear the check box.

[Printer Name]

Enter the name of the machine. If an mDNS name has already been registered in [mDNS Settings] ([▶ Configuring DNS\(P. 51\)](#)), the registered name is displayed.

[Location]

Enter the location of the machine. If a location has already been registered in [Device Information Settings] ([Device Management] in [Management Settings] (Settings/Registration)), the registered name is displayed.

[Latitude]

Enter the latitude of the location where the machine is installed.

[Longitude]

Enter the longitude of the location where the machine is installed.

6 Click [OK].

! IMPORTANT

If you select [Use AirPrint], the following settings in <Network> are set to <On>.

- Use HTTP
- IPP Print Settings
- IPv4 Use mDNS
- IPv6 Use mDNS

NOTE

- If you change [Printer Name] that you have once specified, you may be unable to print any more from the Mac that has been able to be used for printing so far. This phenomenon occurs because <mDNS Name> ([▶ Configuring DNS\(P. 51\)](#)) of IPv4 is also changed automatically. In this case, add the machine to the Mac again.
- Entering the printer name makes it easier to identify multiple printers that support AirPrint.

■ Changing the Setting of Functions Available with AirPrint

If you want to disable functions that you are not going to use with AirPrint or encrypt communications, configure the necessary setting using the operation panel.

Changing Print Settings

To perform printing with AirPrint, IPP protocol is used.

Turning the Function On/Off

You can specify whether to perform printing with AirPrint. The factory default setting is <On>.

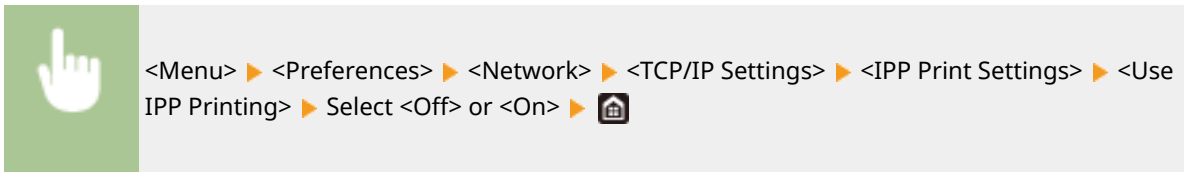

Changing the TLS Setting

You can specify whether to encrypt communications using TLS when performing printing with AirPrint. The factory default setting is <Off>.



Displaying the Screen for AirPrint

You can display the screen for AirPrint, on which you can not only access the AirPrint Settings but also view information about consumables, such as paper and toner cartridge. Further, you can configure security function settings.

- 1** Select [System Preferences] ▶ [Printers & Scanners], then add the machine to the Mac you are using.
 - If the machine has already been added, this operation is not required.
- 2** Select this machine from the list of printers in [Printers & Scanners].
- 3** Click [Options & Supplies].
- 4** Click [Show Printer Webpage].
- 5** Log in to the Remote UI.
 - To change the AirPrint settings, it is necessary to log in as an administrator.

■ AirPrint-Dedicated Page

When you log in with administrator privileges, the AirPrint-dedicated page is displayed as shown below.

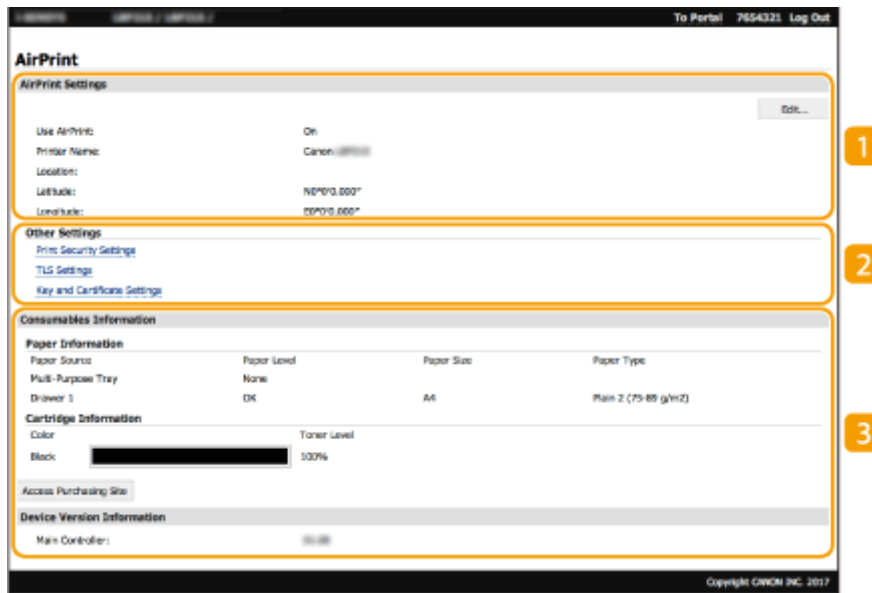

1 [AirPrint Settings]

Enables you to check the values entered in the AirPrint settings, such as the name and location of the machine. You can click [Edit] to change the settings.

2 [Other Settings]

[Print Security Settings]

Configure the print security settings using TLS or authentication.

[TLS Settings]

Enables you to change the key and certificate used for TLS. ▶ **Configuring the Key and Certificate for TLS(P. 195)**

[Key and Certificate Settings]

Enables you to generate and install a key and certificate, or request a certificate to be issued. ▶ **Configuring the Key and Certificate for TLS(P. 195)**

3 [Consumables Information]

Enables you to check the information of each paper source and consumables of the machine and the device version.

Trademarks

Apple, Bonjour, iPad, iPhone, iPod touch, Mac, macOS, OS X and Safari are trademarks of Apple Inc., registered in the U.S. and other countries. AirPrint and the AirPrint logo are trademarks of Apple Inc.

Printing with AirPrint

7YX2-03S

You can print from an iPad, iPhone, iPod touch, or Mac without using a printer driver.

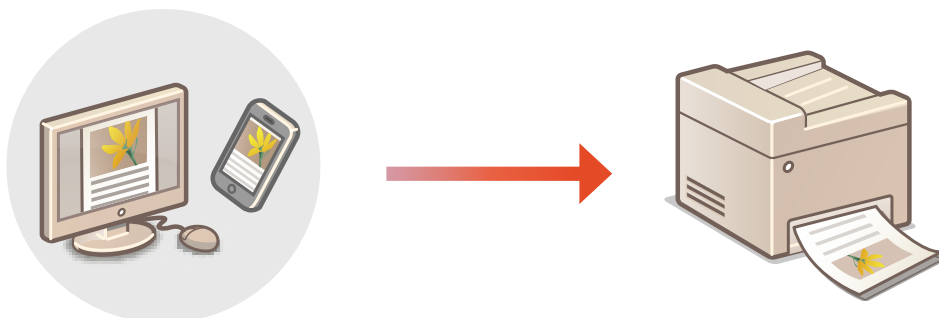

▶ **Printing from an iPad, iPhone, or iPod touch(P. 164)**

▶ **Printing from a Mac(P. 165)**

System Requirements

One of the following Apple devices is required to print with AirPrint.

- iPad (all models)
- iPhone (3GS or later)
- iPod touch (3rd generation or later)
- Mac (Mac OS X 10.7 or later)*

*OS X v10.9 or later when using a USB connection

Network Environment

One of the following environments is required.

- An environment where an Apple device and the machine are connected to the same LAN
- An environment where an Apple device and the machine are connected directly
- An environment where a Mac is connected to the machine via USB

! IMPORTANT

- For printing, it is required to set <Use IPP Printing> to <On>. ▶ **Changing the Setting of Functions Available with AirPrint(P. 162)**

Printing from an iPad, iPhone, or iPod touch

1 Make sure that the machine is turned ON and connected to the Apple device.

- For how to make sure of this, see ▶ **Setting Up the Network Environment(P. 11)** .
- For information on the Direct Connection, see ▶ **Connecting Directly (Access Point Mode)(P. 154)** .

2 From the application on your Apple device, tap  to display the menu options.

3 Tap [Print].

4 Select this machine from [Printer].

- The printers connected to the network are displayed here. Select this machine in this step.

! IMPORTANT:

- The screen for selecting this machine in [Printer] is not displayed on applications that do not support AirPrint. You cannot print by using those applications.

5 Specify the print settings as necessary.

NOTE:

- The available settings and paper sizes differ depending on the application you are using.

6 Tap [Print].

▢ Printing starts.

NOTE:

Checking the print status

- During printing, press the Home button of the Apple device twice ► tap [Print].

Printing from a Mac

1 Make sure that the machine is turned ON and connected to the Mac.

- For how to make sure of this, see [▶ Setting Up the Network Environment \(P. 11\)](#) .

2 Add the machine to the Mac from [System Preferences] ► [Printers & Scanners].

- If the machine has already been added, this operation is not required.

3 Open a document in an application and display the print dialog box.

- How to display the print dialog box differs for each application. For more information, see the instruction manual or Help for the application you are using.

4 Select the machine in the print dialog box.

- The printers connected to the Mac are displayed. Select this machine in this step.

5 Specify the print settings as necessary.

NOTE:

- The available settings and paper sizes differ depending on the application you are using.

6 Click [Print].

- ▣ Printing starts.

If AirPrint Cannot Be Used

7YX2-03U

If AirPrint cannot be used, try taking the following solutions.

- Make sure that the machine is turned ON. If the machine is turned ON, first turn it OFF, then wait for at least 10 seconds and then turn it back ON to check if the problem is solved.
- Make sure that no error messages are displayed on the machine.
- Make sure that Apple devices and the machine are connected to the same LAN. If the machine is turned ON, it may take several minutes before the machine is ready for communication.
- Make sure that Bonjour on your Apple device is enabled.
- Make sure that the machine is configured to enable execution of jobs from a computer even when no department ID and password are entered. ▶ **Blocking Jobs When Department ID Is Unknown(P. 179)**
- For printing, make sure that the paper is loaded in the machine and that the machine contains a sufficient amount remaining in the toner cartridges. ▶ **Displaying the Screen for AirPrint(P. 162)**

Managing the Machine by the Remote Control

7YX2-03W

You can use the Remote UI from a smart phone or tablet Web browser. You can confirm the machine status or perform various settings from a mobile device. Note that the Remote UI screen may not be displayed properly for some devices and environments.



Starting the Remote UI from Mobile Devices

Enter the IP address of the machine on the Web browser to start the Remote UI. Prior to operation, confirm the IP address set for the machine ([Viewing Network Settings\(P. 34\)](#)). If it is unknown, ask your network administrator.

1 Start the Web browser of the mobile device.

2 Enter "http://<the IP address of the machine>/" in the address entry column.

- If you want to use an IPv6 address, enclose the IPv6 address with brackets.
Example: http://[fe80:2e9e:fcff:fe4e:dbce]/

NOTE:

- For a "Smartphone Version" of the Remote UI, a portion of items displayed are omitted. If you want to confirm all of the items, see the "PC Version."

LINKS

- [Managing the Machine from a Computer \(Remote UI\)\(P. 227\)](#)

Managing the Machine

Managing the Machine	170
Setting Access Privileges	172
Setting the System Manager ID and PIN	173
Setting the Department ID Management	175
Setting a Remote UI PIN	181
Configuring the Network Security Settings	183
Restricting Communication by Using Firewalls	185
Specifying IP Addresses for Firewall Settings	186
Specifying MAC Addresses for Firewall Settings	189
Changing Port Numbers	192
Setting a Proxy	193
Configuring the Key and Certificate for TLS	195
Generating the Key and Certificate for Network Communication	199
Configuring the Expiration Check Method for Received Certificates	202
Generating a Key and Certificate Signing Request (CSR)	204
Registering the Key and Certificate for Network Communication	207
Configuring IPsec Settings	209
Configuring IEEE 802.1X Authentication Settings	216
Restricting the Machine's Functions	220
Restricting Printing from a Computer	222
Restricting USB Functions	223
Disabling HTTP Communication	224
Disabling Remote UI	225
Restricting Use of the Operation Panel	226
Managing the Machine from a Computer (Remote UI)	227
Starting Remote UI	228
Checking the Status and Logs	231
Setting Up Menu Options from Remote UI	237
Security Policy	240
Importing/Exporting the Setting Data	245
Updating the Firmware	248
Initializing Settings	251

Managing the Machine

7YX2-03X

To reduce the various risks associated with the use of this machine, such as leaks of personal information or unauthorized use by third parties, constant and effective security measures are required. An administrator should manage important settings, such as access privileges and security settings, to ensure that the machine is used safely.

■ Configuring the Basic Management System

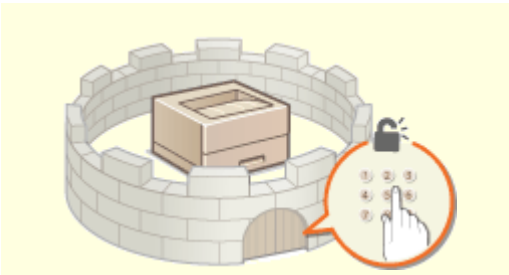

▶ **Setting Access Privileges(P. 172)**

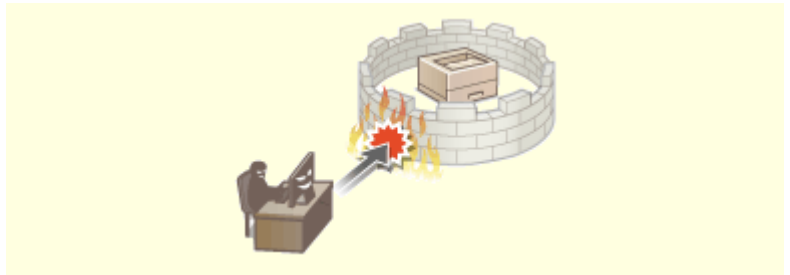

▶ **Configuring the Network Security Settings(P. 183)**

■ Preparing for Risks from Negligence or Misuse



▶ **Restricting the Machine's Functions(P. 220)**

■ Ensuring Effective Management



▶ **Managing the Machine from a Computer (Remote UI)(P. 227)**

■ Managing the System Configuration and Settings

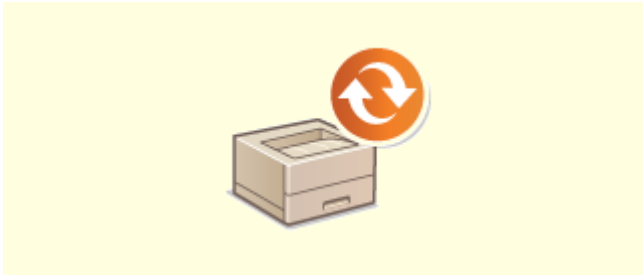

▶ **Updating the Firmware(P. 248)**

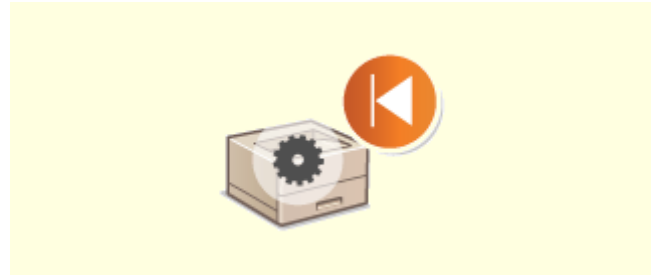

▶ **Initializing Settings(P. 251)**

Setting Access Privileges

7YX2-03Y

Protect the machine from unauthorized access by only allowing users with access privileges to use the machine. Access privileges are set separately for system administrators, general users, and the Remote UI. When privileges are set, the user must enter an ID and PIN to print or change settings.

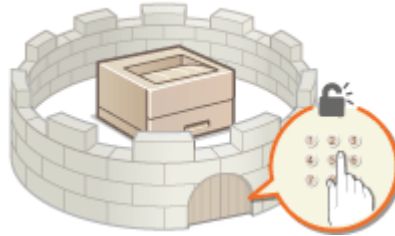

Set up an account with full access privileges called "System Manager ID" for a system manager. Registering an account called "Department ID" allows you to manage general users. Using a Department ID, you can set a PIN for using this machine as well as keep track of the number of pages printed for each department ID. And by setting a Remote UI Access PIN, you can restrict use of the Remote UI.

System Manager ID

System Manager ID is an account with full access privileges. If you specify a System Manager ID, you need to log on to the machine using the System Manager ID information in order to access items that requires administrator privileges such as <Network> and <Management Settings>. We recommend that you set and register the System Manager ID. Otherwise, anyone will be able to change the machine settings. Only one System Manager ID can be registered. [▶Setting the System Manager ID and PIN\(P. 173\)](#)

Department ID (Department ID Management)

You can specify access privileges for a user (or group of users) by registering a Department ID. You can register multiple Department IDs. If a user tries to operate the machine when Department IDs are enabled, a login screen is displayed, and the user must enter their own Department ID and PIN to use the machine. Information such as how many pages have been printed for each Department ID can be compiled. [▶Setting the Department ID Management\(P. 175\)](#)

Remote UI PIN (Remote UI Access PIN)

This is a PIN for using the Remote UI. Only users who know the PIN can access the Remote UI. [▶Setting a Remote UI PIN\(P. 181\)](#)

Setting the System Manager ID and PIN

7YX2-040

Set the system manager account, "System Manager ID." You can also set a PIN for the System Manager ID. If the System Manager ID is specified, you can access items that require administrator privileges, for example, <Network> and <Management Settings>, only when the System Manager ID and PIN have been entered correctly. The System Manager ID settings information is critical to the security of the machine, so make sure that only Administrators know the System Manager ID and PIN.

1 Select <Menu> in the Home screen. Home Screen(P. 91)

2 Select <Management Settings>.

NOTE:



If the System Manager ID has already been set

- If the login screen appears, enter the correct ID and PIN.  Logging in to the Machine(P. 100)

3 Select <User Management> <System Manager Information Settings>.



4 Select <System Manager ID and PIN>.

5 Specify the System Manager ID and PIN.

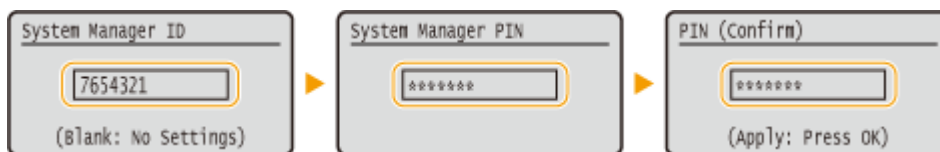
- Specify the <System Manager ID>  <System Manager PIN>.
- Enter numbers for each item, and press .
- The Confirm screen is displayed. Enter the PIN once again to confirm.



NOTE:

- You cannot register an ID or PIN that consists only of zeros, such as "00" or "0000000."
- To cancel the System Manager ID and PIN settings, clear the information you entered in  and press  with the fields blank.

■ Setting the System Manager Name

- 1 Select <System Manager Name>.
- 2 Enter the System Manager Name, and select <Apply>.
 - On how to enter text, see  Entering Text(P. 97) .

IMPORTANT

- Do not forget your PIN. If you forget your PIN, contact your dealer or service representative.

NOTE

Configuring settings via the Remote UI

- Start the Remote UI and log in to System Manager Mode. Click [Settings/Registration] ▶ [User Management] ▶ [System Manager Information] ▶ [Edit] and specify the necessary settings on the displayed screen.
- By using the Remote UI, you can register a variety of information, including contact information, Administrator comments, the installation location of the machine, as well as the settings that you can register by using the operation panel. The registered information can be viewed on the [Device Information] page of the Remote UI. ▶ **Checking System Manager Information(P. 234)**

Logging in to the machine

- If you try to access items that require administrator privileges, for example, <Network> and <Management Settings>, when the System Manager ID is specified, the Login screen is displayed. ▶ **Logging in to the Machine(P. 100)**
- You must also enter the System Manager ID and PIN to log in using the Remote UI in System Manager Mode. ▶ **Starting Remote UI(P. 228)**

LINKS

- ▶ **Setting Access Privileges(P. 172)**
- ▶ **Setting the Department ID Management(P. 175)**

Setting the Department ID Management

7YX2-041

You can control access to the machine by using multiple IDs for multiple users or groups. If a user tries to operate the machine when Department ID Management is enabled, a login screen is displayed, and the user must enter their own Department ID and PIN to use the machine. When Department ID Management is enabled, usage of functions, such as printing, is recorded for each Department ID. To configure Department ID Management, register department IDs as necessary and then enable Department ID Management function. Additional settings are required if you want to enable Department ID Management for operation from a computer.

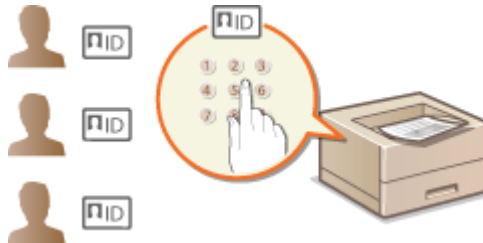

- ▶ **Registering/Editing Department ID and PIN(P. 175)**
- ▶ **Enabling the Department ID Management(P. 177)**
- ▶ **Enabling the Department ID Management for Jobs from a Computer(P. 178)**
- ▶ **Blocking Jobs When Department ID Is Unknown(P. 179)**

NOTE

- For more information about the basic operations to be performed when setting the machine from the Remote UI, see ▶ **Setting Up Menu Options from Remote UI(P. 237)** .

Registering/Editing Department ID and PIN

Register a Department ID and set a PIN for it. Register all the department IDs to be managed.

- 1 Start the Remote UI and log in to System Manager Mode. ▶ Starting Remote UI(P. 228)**
- 2 Click [Settings/Registration] on the Portal page. ▶ Remote UI Screen(P. 229)**
- 3 Select [User Management] ▶ [Department ID Management].**
- 4 Register or edit Department IDs.**

■ Registering a Department ID

- 1** Click [Register New Department].
- 2** Specify the required settings.

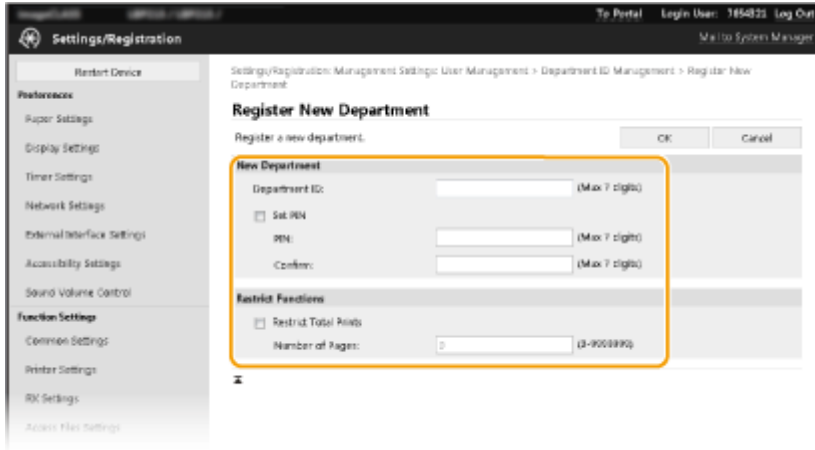

[Department ID]
Enter the Department ID number to be registered.

[Set PIN]
To set a PIN, select the check box and enter the same number both in the [PIN] and [Confirm] text boxes.

[Restrict Functions]
You can restrict the number of pages to print for departments to be registered. To restrict the number of pages to print, select the check box for the target type, and enter the appropriate number of pages in [Number of Pages].

3 Click [OK].

■ Editing the settings of the registered Department ID

- 1** Click the corresponding text link under [Department ID] to edit.
- 2** Change the settings as necessary and click [OK].

NOTE:

Deleting a Department ID

- Click [Delete] on the right of the Department ID you want to delete ► click [OK].

NOTE

[Department ID Page Total]

- You can check the total number of pages for jobs that have been executed to date on a department ID basis.
- If you want to return the counts to zero, click the corresponding text link under [Department ID] and click [Clear Count] ► [OK]. If you want to return the counts of all Department IDs to zero, click [Clear All Counts] ► [OK].

Department ID Page Total			
Register New Department...		Clear All Counts	
Department ID	Page Total/Page Restriction		
	Total Prints		
	Total		
7654521	0		
000001	5	Delete	Clear Count
000002	1	Delete	Clear Count
Unknown ID Jobs	0		
RX Print	0		

Enabling the Department ID Management

After you register as many Department IDs as necessary, enable Department ID Management.

- 1 Start the Remote UI and log in to System Manager Mode. ▶ Starting Remote UI(P. 228)
- 2 Click [Settings/Registration] on the Portal page. ▶ Remote UI Screen(P. 229)
- 3 Select [User Management] ▶ [Department ID Management].
- 4 Click [Edit].
- 5 Select the [Department ID Management] check box.

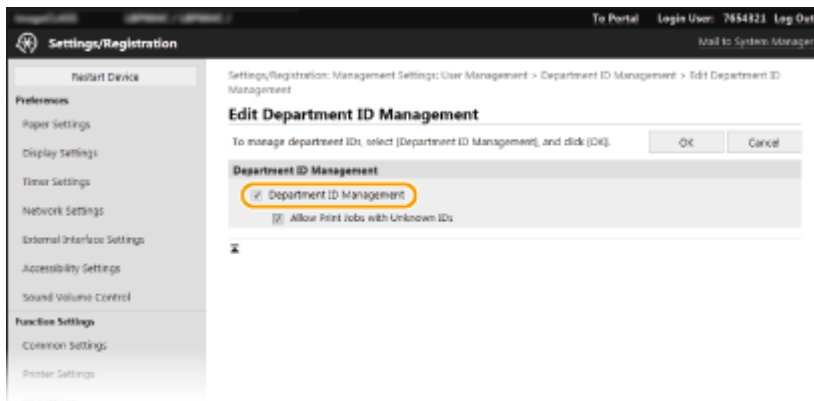

[Department ID Management]

Select the check box to enable Department ID Management. If you do not want to use Department ID Management, clear the check box.

NOTE:

- For information about [Allow Print Jobs with Unknown IDs], see ▶ Blocking Jobs When Department ID Is Unknown(P. 179) .

- 6 Click [OK].

NOTE

Using the operation panel

- Department ID Management settings can also be accessed from <Menu> in the Home screen. ▶ <Department ID Management>(P. 329)

Logging in to the machine

- When you try to operate the machine when Department ID Management is enabled, the login screen is displayed. ▶ Logging in to the Machine(P. 100)

Enabling the Department ID Management for Jobs from a Computer

When you want to enable Department ID Management for jobs from a computer, you need to specify the department ID and PIN using the driver pre-installed on each computer.

! IMPORTANT

- To perform the following procedure, log in to your computer with an administrator account.

- 1 Open the printer folder. ▶ **Displaying the Printer Folder(P. 398)**
- 2 Right-click the driver icon for this machine, and click **[Printer properties]** or **[Properties]**.
- 3 Click the **[Device Settings]** tab.
- 4 Select **[Department ID Management]** under **[User Management]**.
- 5 Click **[Settings]** found to the right.
- 6 Specify the settings as necessary and click **[OK]**.

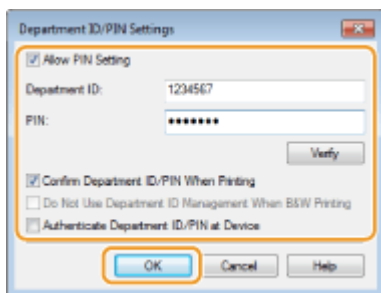

[Allow PIN Setting]

Select the check box to enable the PIN setting.

[Department ID]

Enter the Department ID number.

[PIN]

Enter the PIN corresponding to the Department ID as necessary.

[Verify]

Click to verify that the correct ID and PIN are entered. This function is not available if the machine and the computer are connected via a USB or WSD (Web Services on Devices) port.

[Confirm Department ID/PIN When Printing]

Select the check box to display the **[Confirm Department ID/PIN]** pop-up screen each time you send job from a computer.

[Authenticate Department ID/PIN at Device]

Select the check box if the machine and the computer are connected via a USB or WSD port.

7 Click [OK].

NOTE

Logging in to the machine

- When you try to send job from a computer when Department ID Management is enabled, the following pop-up screen is displayed (unless the [Confirm Department ID/PIN When Printing] check box is cleared):

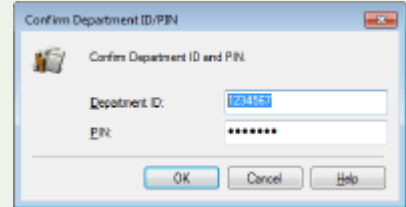

Blocking Jobs When Department ID Is Unknown

"Printing from computer" is configured by default so that the user can execute jobs without entering an ID and PIN even while Department ID Management is enabled. When you want to configure a setting so that functions cannot be used unless the ID and PIN are entered, perform the following procedure.

- 1** Start the Remote UI and log in to System Manager Mode. **▶ Starting Remote UI(P. 228)**
- 2** Click [Settings/Registration] on the Portal page. **▶ Remote UI Screen(P. 229)**
- 3** Select [User Management] ▶ [Department ID Management].
- 4** Click [Edit].
- 5** Clear the check boxes as necessary.

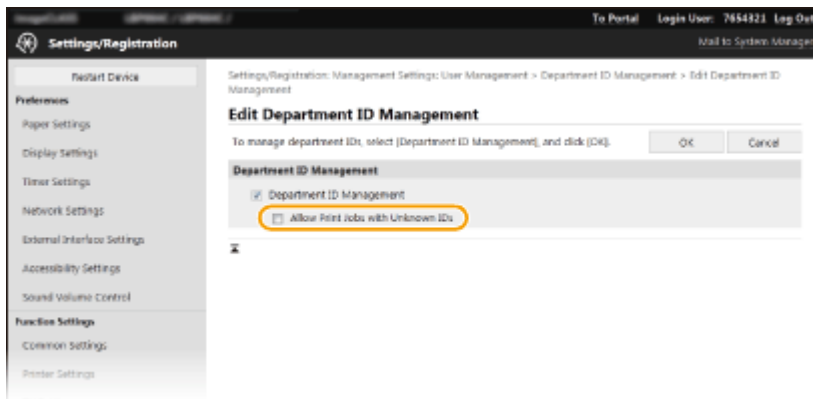

[Allow Print Jobs with Unknown IDs]

In order to send job from a computer when Department ID Management is enabled, you need to enter the correct ID and PIN (**▶ Enabling the Department ID Management for Jobs from a Computer(P. 178)**). However, if the check box is selected for this setting, jobs are executed even when the ID and PIN are not

entered. When you want to configure a setting so that no jobs are executed unless the correct department ID and PIN are entered, clear the check box.

6 Click [OK].

LINKS

- ▶ **Setting Access Privileges(P. 172)**
- ▶ **Setting the System Manager ID and PIN(P. 173)**

Setting a Remote UI PIN

7YX2-042

You can set a PIN for access to the Remote UI. All users use a common PIN.

NOTE

- When Department ID Management is enabled, setting here is not required. ▶ [Setting the Department ID Management\(P. 175\)](#)

1 Select **<Menu>** in the Home screen. ▶ [Home Screen\(P. 91\)](#)

2 Select **<Management Settings>**.

- If the login screen appears, enter the correct ID and PIN. ▶ [Logging in to the Machine\(P. 100\)](#)

3 Select **<Remote UI Settings/Update Firmware>** ▶ **<Remote UI Settings>** ▶ **<Remote UI Access Security Settings>**.

4 Select **<On>**.

5 Specify the Remote UI Access PIN.

- Enter a PIN, and press **OK**.
- The Confirm screen is displayed. Enter the PIN once again to confirm.

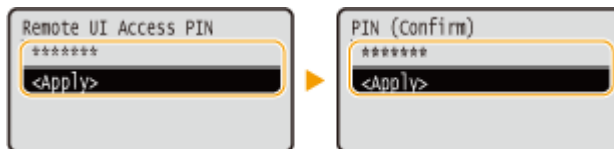

NOTE:

- You cannot register a PIN that consists only of zeros, such as "00" or "0000000."

! IMPORTANT

- Do not forget your PIN. If you forget your PIN, use the procedure above to set a new PIN.

NOTE

If **<Management Settings>** are initialized

- The Remote UI Access PIN is also initialized. After an initialization, reset the PIN. ▶ [<Initialize Menu>\(P. 336\)](#)

LINKS

- ▶ **Setting Access Privileges(P. 172)**
- ▶ **Setting the System Manager ID and PIN(P. 173)**

Configuring the Network Security Settings

7YX2-043

Authorized users may incur unanticipated losses from attacks by malicious third parties, such as sniffing, spoofing, and tampering of data as it flows over a network. To protect your important and valuable information from these attacks, the machine supports the following features to enhance security and secrecy.

Firewall Settings

Unauthorized access by third parties, as well as network attacks and intrusions, can be blocked by limiting communication only to devices that have a specific IP address or MAC address. [Restricting Communication by Using Firewalls\(P. 185\)](#)



Changing Port Numbers

A protocol that is used to exchange information with other devices is assigned port numbers that are predetermined according to the type of protocol. The port number must be the same for all communication devices; therefore, changing it to an arbitrary number is important to prevent hacking from outside. [Changing Port Numbers\(P. 192\)](#)

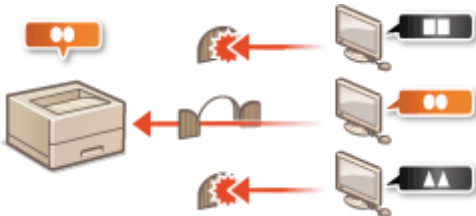

Proxy Settings

When the client devices are connected to an external network, communication is established through the proxy server. When the proxy server is used, websites can be browsed more safely, therefore, security can be expected to be enhanced. [Setting a Proxy\(P. 193\)](#)



TLS Encrypted Communication

TLS is a protocol for encryption for data sent over a network and is often used for communication via a Web browser or an e-mail application. TLS enables secure network communication when you access the machine from a computer via the Remote UI. [Configuring the Key and Certificate for TLS\(P. 195\)](#)



IPSec Communication

While TLS only encrypts data used on a specific application, such as a Web browser or an e-mail application, IPSec encrypts the whole (or payloads of) IP packets. This enables IPSec to offer a more versatile security system than TLS. [Configuring IPSec Settings\(P. 209\)](#)

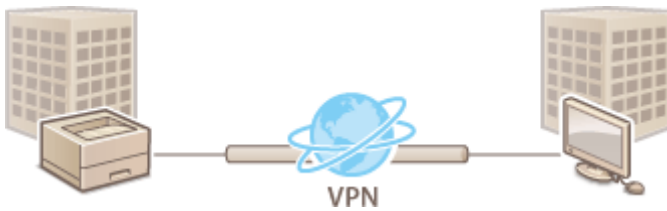

IEEE 802.1X Authentication

IEEE 802.1X is a standard and mechanism for blocking unauthorized access to the network by collectively managing user authentication information. If a device tries to connect to the 802.1X network, the device must go through user authentication in order to prove that the connection is made by an authorized user. Authentication information is sent to and checked by a RADIUS server, which permits or rejects communication to the network depending on the authentication result. If authentication fails, a LAN switch (or an access point) blocks access from the outside of the network. The machine can connect to an 802.1X network as a client device. [Configuring IEEE 802.1X Authentication Settings\(P. 216\)](#)

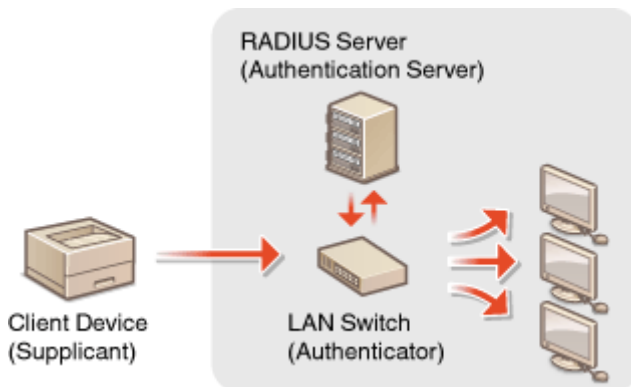

Restricting Communication by Using Firewalls

7YX2-044

Without proper security, unauthorized third parties can access computers and other communication devices that are connected to a network. To prevent this unauthorized access, specify the settings for packet filter, a feature that restricts communication to devices with specified IP addresses or MAC addresses.

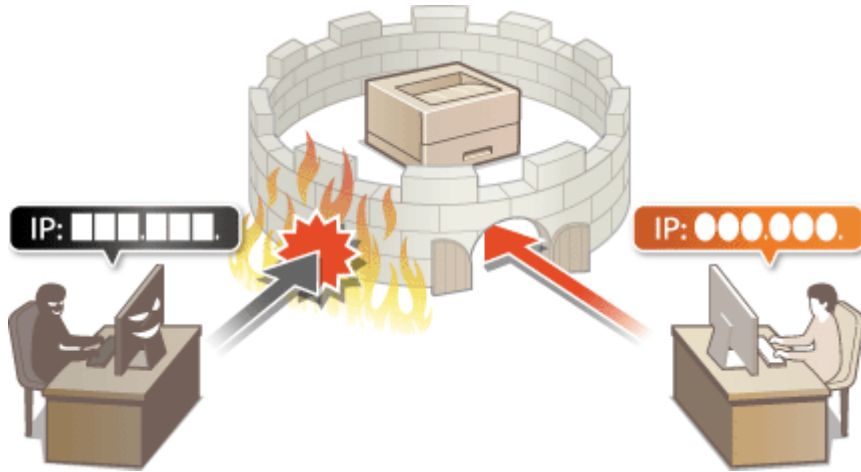

- [Specifying IP Addresses for Firewall Settings\(P. 186\)](#)
- [Specifying MAC Addresses for Firewall Settings\(P. 189\)](#)

Specifying IP Addresses for Firewall Settings

7YX2-045

You can either limit communication to only devices with specified IP addresses, or block devices with specified IP addresses but permit other communications. You can specify a single IP address or a range of IP addresses.

NOTE

- For more information about the basic operations to be performed when setting the machine from the Remote UI, see [▶Setting Up Menu Options from Remote UI\(P. 237\)](#) .

1 Start the Remote UI and log in to System Manager Mode. [▶Starting Remote UI\(P. 228\)](#)

2 Click [Settings/Registration] on the Portal page. [▶Remote UI Screen\(P. 229\)](#)

3 Select [Network Settings] ▶ [Firewall Settings].

4 Click [Edit] for the target IP address filter.

- Select the filter that matches the target IP address. To restrict data sent from the machine to a computer, select [Outbound Filter]. To restrict data received from a computer, select [Inbound Filter].

5 Specify the settings for packet filtering.

- Select the default policy to allow or reject the communication of other devices with the machine, and then specify IP addresses for exceptions.

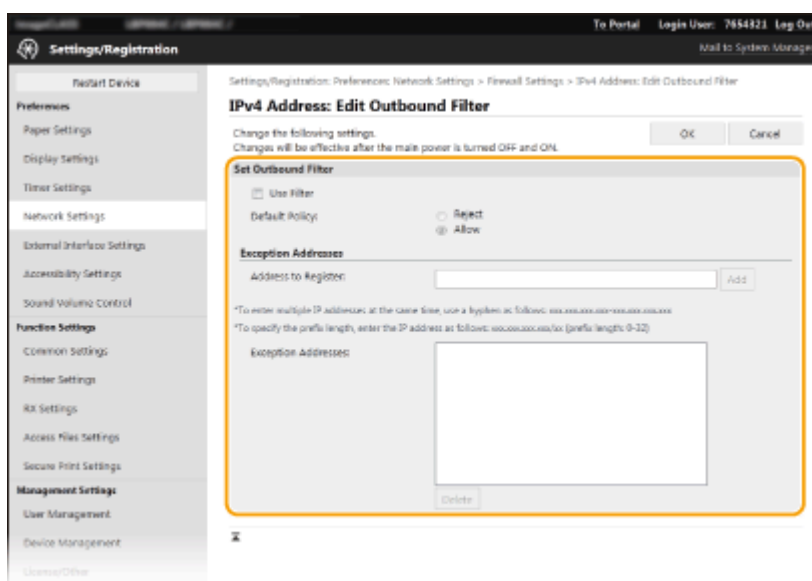

1 Select the [Use Filter] check box and click the [Reject] or [Allow] radio button for the [Default Policy].

[Use Filter]

Select the check box to restrict communication. Clear the check box to disable the restriction.

[Default Policy]

Select the precondition to allow or reject the communication of other devices with the machine.

[Reject]	Select to pass communication packets only when they are sent to or received from devices whose IP addresses are entered in [Exception Addresses]. Communications with other devices are prohibited.
[Allow]	Select to block communication packets when they are sent to or received from devices whose IP addresses are entered in [Exception Addresses]. Communications with other devices are permitted.

2 Specify address exceptions.

- Enter the IP address (or the range of IP addresses) in the [Address to Register] text box and click [Add].

! IMPORTANT:

Check for entry errors

- If IP addresses are incorrectly entered, you may be unable to access the machine from the Remote UI, in which case you need to set <IPv4 Address Filter> or <IPv6 Address Filter> to <Off>.
 - ▶ <IPv4 Address Filter>(P. 279)
 - ▶ <IPv6 Address Filter>(P. 279)

NOTE:

Entry form for IP addresses

	Description	Example
Entering a single address	IPv4: Delimit numbers with periods.	192.168.0.10
	IPv6: Delimit alphanumeric characters with colons.	fe80::10
Specifying a range of addresses	Insert a hyphen between the addresses.	192.168.0.10-192.168.0.20
Specifying a range of addresses with a prefix	Enter the address, followed by a slash and a number indicating the prefix length.	192.168.0.32/27 fe80::1234/64

When [Reject] is selected for an outbound filter

- Outgoing multicast and broadcast packets cannot be filtered.

Deleting an IP address from exceptions

- Select an IP address and click [Delete].

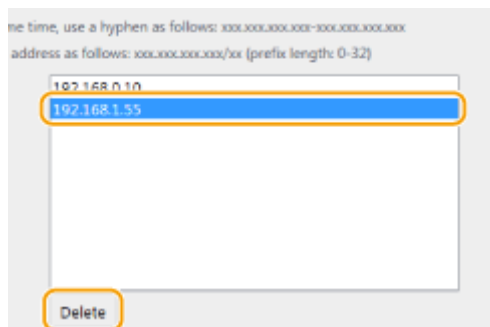

3 Click [OK].

6 Restart the machine. ▶ [Restarting the Machine\(P. 87\)](#)

NOTE

Using the operation panel

- You can also enable or disable IP address filtering from <Menu> in the Home screen.
 - ▶ [IPv4 Address Filter>\(P. 279\)](#)
 - ▶ [IPv6 Address Filter>\(P. 279\)](#)

LINKS

▶ [Specifying MAC Addresses for Firewall Settings\(P. 189\)](#)

Specifying MAC Addresses for Firewall Settings

7YX2-046

You can limit communication to only devices with specified MAC addresses, or block devices with specified MAC addresses but permit other communications.

IMPORTANT

This function is unavailable when the machine is connected to a wireless LAN.

NOTE

- For more information about the basic operations to be performed when setting the machine from the Remote UI, see [▶Setting Up Menu Options from Remote UI\(P. 237\)](#) .

- 1 Start the Remote UI and log in to System Manager Mode.** [▶Starting Remote UI\(P. 228\)](#)
- 2 Click [Settings/Registration] on the Portal page.** [▶Remote UI Screen\(P. 229\)](#)
- 3 Select [Network Settings] ▶ [Firewall Settings].**
- 4 Click [Edit] for the target MAC address filter.**
 - To restrict data sent from the machine to a computer, select [Outbound Filter]. To restrict data received from a computer, select [Inbound Filter].
- 5 Specify the settings for packet filtering.**
 - Select the precondition (default policy) to allow or reject the communication of other devices with the machine, and then specify MAC addresses for exceptions.

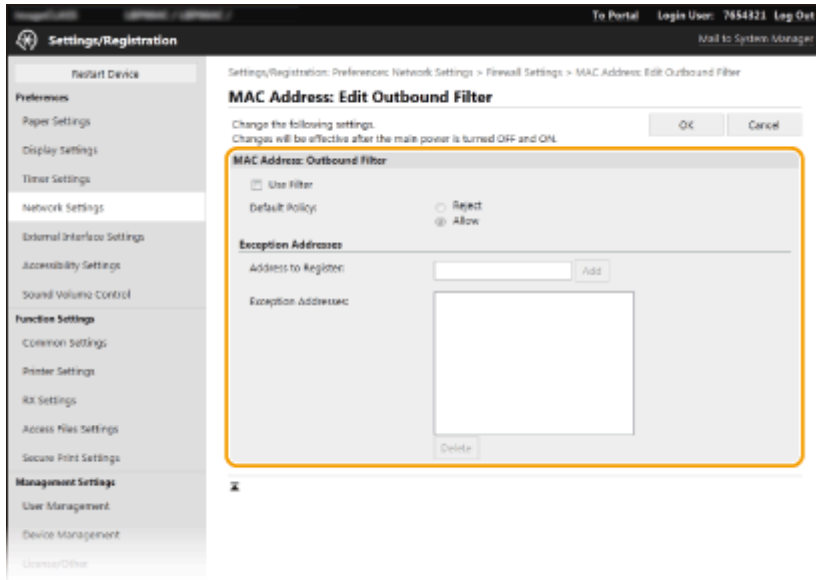

- 1 Select the [Use Filter] check box and click the [Reject] or [Allow] radio button for the [Default Policy].

[Use Filter]

Select the check box to restrict communication. Clear the check box to disable the restriction.

[Default Policy]

Select the precondition to allow or reject other devices to communicate with the machine.

[Reject]	Select to pass communication packets only when they are sent to or received from devices whose MAC addresses are entered in [Exception Addresses]. Communications with other devices are prohibited.
[Allow]	Select to block communication packets when they are sent to or received from devices whose MAC addresses are entered in [Exception Addresses]. Communications with other devices are permitted.

- 2 Specify address exceptions.
 - Enter the MAC address in the [Address to Register] text box and click [Add].
 - You do not need to delimit the address with hyphens or colons.

! IMPORTANT:

Check for entry errors

- If MAC addresses are incorrectly entered, you may become unable to access the machine from the Remote UI, in which case you need to set <MAC Address Filter> to <Off>. **▶MAC Address Filter>(P. 279)**

NOTE:

When [Reject] is selected for an outbound filter

- Outgoing multicast and broadcast packets cannot be filtered.

Deleting a MAC address from exceptions

- Select a MAC address and click [Delete].

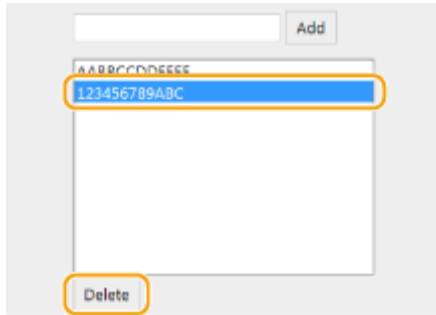

3 Click [OK].

6 Restart the machine. ▶ [Restarting the Machine\(P. 87\)](#)

NOTE

Using the operation panel

- You can also enable or disable MAC address filtering from <Menu> in the Home screen. ▶ [<MAC Address Filter>\(P. 279\)](#)

LINKS

▶ [Specifying IP Addresses for Firewall Settings\(P. 186\)](#)

Changing Port Numbers

7YX2-047

Ports serve as endpoints for communicating with other devices. Typically, conventional port numbers are used for major protocols, but devices that use these port numbers are vulnerable to attacks because these port numbers are well-known. To enhance security, your Network Administrator may change the port numbers. When a port number has been changed, the new number must be shared with the communicating devices, such as computers and servers. Specify the port number settings depending on the network environment.

NOTE

- To change the port number for proxy server, see [▶Setting a Proxy\(P. 193\)](#) .

1 Select <Menu> in the Home screen. [▶Home Screen\(P. 91\)](#)

2 Select <Preferences> ▶ <Network>.

- If the login screen appears, enter the correct ID and PIN. [▶Logging in to the Machine\(P. 100\)](#)

3 Select <TCP/IP Settings> ▶ <Port Number Settings>.

4 Selecting the protocol of which you want to change the port number.

NOTE:

Learning more about the protocols

- <LPD>/<RAW>/<WSD Multicast Discovery> [▶Configuring Printing Protocols and WSD Functions\(P. 37\)](#)
- <HTTP> [▶Disabling HTTP Communication\(P. 224\)](#)
- <POP3> [▶Receiving I-Faxes for Printing\(P. 147\)](#)
- <SNMP> [▶Monitoring and Controlling the Machine with SNMP\(P. 59\)](#)
- <Multicast Discovery> [▶Monitoring the Machine from the Device Management Systems\(P. 64\)](#)

5 Enter the port number, and press **OK**.

6 Restart the machine. [▶Restarting the Machine\(P. 87\)](#)

LINKS

- [▶Configuring Printer Ports\(P. 40\)](#)

Setting a Proxy

7YX2-048

A proxy (or HTTP proxy server) refers to a computer or software that carries out HTTP communication for other devices, especially when communicating with resources outside the network, such as when browsing Web sites. The client devices connect to the outside network through the proxy server, and do not communicate directly to the resources outside. Setting a proxy not only facilitates management of traffic between in-house and outside networks but also blocks unauthorized access and consolidates anti-virus protection for enhanced security. When setting a proxy, make sure that you have the necessary proxy information, including the IP address, port number, and a user name and password for authentication.

NOTE

- For more information about the basic operations to be performed when setting the machine from the Remote UI, see [Setting Up Menu Options from Remote UI\(P. 237\)](#) .

- 1 Start the Remote UI and log in to System Manager Mode. [Starting Remote UI\(P. 228\)](#)**
- 2 Click [Settings/Registration] on the Portal page. [Remote UI Screen\(P. 229\)](#)**
- 3 Select [Network Settings] ▶ [Proxy Settings].**
- 4 Click [Edit].**
- 5 Select the [Use Proxy] check box and specify the required settings.**

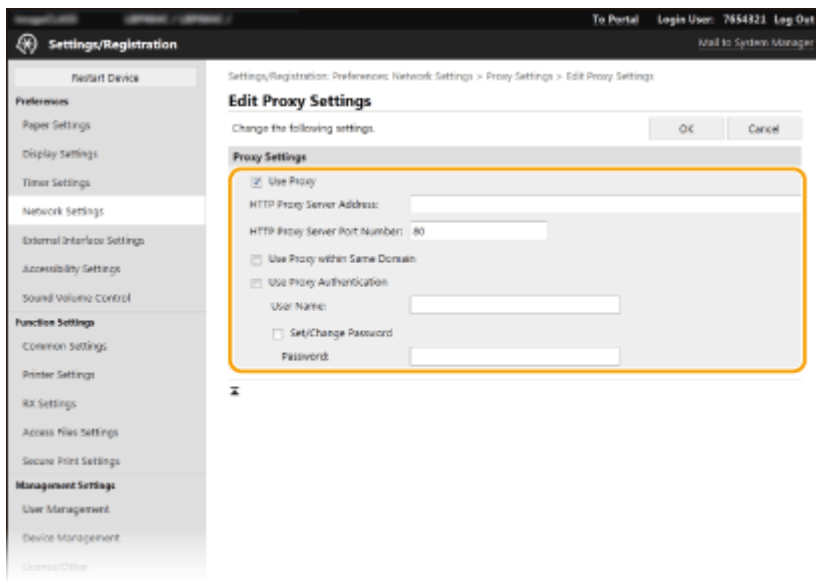

[Use Proxy]

Select the check box to use the specified proxy server when communicating with an HTTP server.

[HTTP Proxy Server Address]

Enter the address of the proxy server. Specify the IP address or host name depending on the environment.

[HTTP Proxy Server Port Number]

Change the port number as necessary.

[Use Proxy within Same Domain]

Select the check box to also use the specified proxy server for communication with devices in the same domain.

[Use Proxy Authentication]

To enable authentication by the proxy server, select the check box and enter alphanumeric characters for the user name in the [User Name] text box.

[Set/Change Password]

To set or change the password for the proxy authentication, when it is enabled, select the check box and enter alphanumeric characters for the new password in the [Password] text box.

6 Click [OK].

Configuring the Key and Certificate for TLS

7YX2-049

You can encrypt communication between the machine and a Web browser on the computer by using Transport Layer Security (TLS). TLS is a mechanism for encrypting data sent or received over the network. TLS must be enabled when the Remote UI is used for specifying settings for IPSec (Pre-Shared Key Method), IEEE 802.1X authentication (TTLS/PEAP), or SNMPv3. To use TLS encrypted communication for the Remote UI, you need to specify a "key and certificate" (server certificate) you want to use before enabling TLS. Generate or install the key and certificate for TLS before enabling TLS ([▶Management Functions\(P. 385\)](#)).



NOTE

- For more information about the basic operations to be performed when setting the machine from the Remote UI, see [▶Setting Up Menu Options from Remote UI\(P. 237\)](#) .

- 1 Start the Remote UI and log in to System Manager Mode. [▶Starting Remote UI\(P. 228\)](#)**
- 2 Click [Settings/Registration] on the Portal page. [▶Remote UI Screen\(P. 229\)](#)**
- 3 Select [Network Settings] ▶ [TLS Settings].**
- 4 Click [Key and Certificate].**
- 5 Click [Register Default Key] on the right of the key and certificate you want to use.**

NOTE:

Viewing details of a certificate

- You can check the details of the certificate or verify the certificate by clicking the corresponding text link under [Key Name], or the certificate icon.

- 6 Click [Edit].**
- 7 Configure detailed TLS settings.**

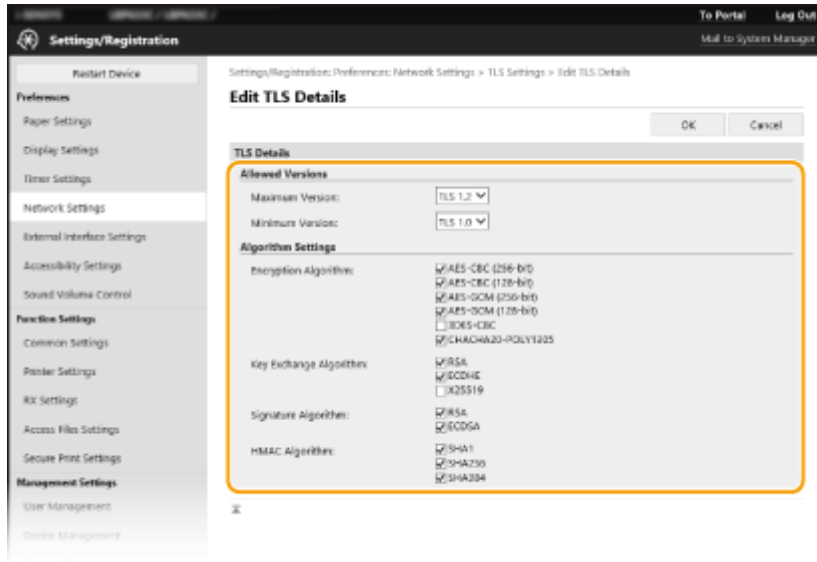

[Allowed Versions]

Specify [Maximum Version] and [Minimum Version] of TLS.

[Algorithm Settings]

Select the check box for the algorithm to use for TLS. Depending on the TLS version, some algorithms may not be available.

✓ : Available — : Unavailable

Algorithm	TLS Version			
	[TLS 1.3]	[TLS 1.2]	[TLS 1.1]	[TLS 1.0]
[Encryption Algorithm]				
[AES-CBC (256-bit)]	—	✓	✓	✓
[AES-CBC (128-bit)]	—	✓	✓	✓
[AES-GCM (256-bit)]	✓	✓	—	—
[AES-GCM (128-bit)]	✓	✓	—	—
[3DES-CBC]	—	✓	✓	✓
[CHACHA20-POLY1305]	✓	—	—	—
[Key Exchange Algorithm]				
[RSA]	—	✓	✓	✓
[ECDHE]	✓	✓	✓	✓
[X25519]	✓	—	—	—
[Signature Algorithm]				
[RSA]	✓	✓	✓	✓
[ECDSA]	✓	✓	✓	✓

Algorithm	TLS Version			
	[TLS 1.3]	[TLS 1.2]	[TLS 1.1]	[TLS 1.0]
[HMAC Algorithm]				
[SHA1]	—	✓	✓	✓
[SHA256]	✓	✓	—	—
[SHA384]	✓	✓	—	—

8 Click [OK].

9 Select [License/Other] ► [Remote UI Settings].

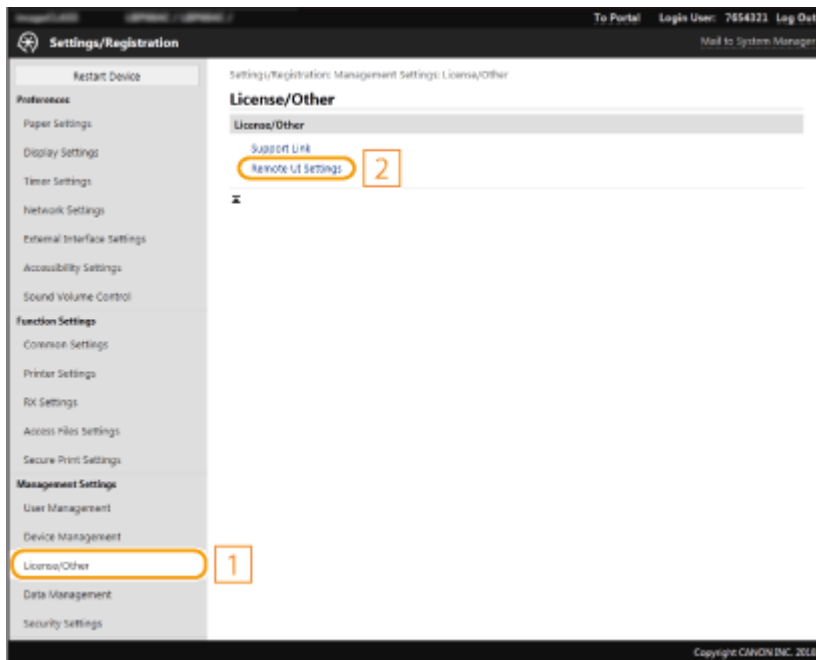

10 Click [Edit].

11 Select the [Use TLS] check box and click [OK].

12 Restart the machine. ► Restarting the Machine(P. 87)

NOTE

Using the operation panel

- You can also enable or disable TLS encrypted communication from <Menu> in the Home screen. ► <Use Remote UI>(P. 333)

Starting the Remote UI with TLS

- If you try to start the Remote UI when TLS is enabled, a security alert may be displayed regarding the security certificate. In this case, check that the correct URL is entered in the address field, and then proceed to display the Remote UI screen. [▶Starting Remote UI\(P. 228\)](#)

Using TLS to encrypt I-Fax reception

- If the POP3 server supports TLS, you can enable TLS for communication with the POP3 server ([▶Configuring the I-Fax RX Settings\(P. 147\)](#)). For more information about the POP3 server, contact your Internet service provider or Network Administrator.

LINKS

- [▶Generating the Key and Certificate for Network Communication\(P. 199\)](#)
- [▶Generating a Key and Certificate Signing Request \(CSR\)\(P. 204\)](#)
- [▶Registering the Key and Certificate for Network Communication\(P. 207\)](#)
- [▶Configuring the Expiration Check Method for Received Certificates\(P. 202\)](#)
- [▶Configuring IPSec Settings\(P. 209\)](#)
- [▶Configuring IEEE 802.1X Authentication Settings\(P. 216\)](#)
- [▶Monitoring and Controlling the Machine with SNMP\(P. 59\)](#)

Generating the Key and Certificate for Network Communication

7YX2-04A

A key and certificate can be generated with the machine when it is required for encrypted communication via Transport Layer Security (TLS). You can use TLS when accessing the machine via the Remote UI. Self-signed certificates are used with the key and certificate generated in "Network Communication."

NOTE

- If you want to use a server certificate that has a CA signature, you can generate a CSR together with a key instead of a certificate. [▶Generating a Key and Certificate Signing Request \(CSR\)\(P. 204\)](#)
- For more information about the basic operations to be performed when setting the machine from the Remote UI, see [▶Setting Up Menu Options from Remote UI\(P. 237\)](#) .

- 1 Start the Remote UI and log in to System Manager Mode.** [▶Starting Remote UI\(P. 228\)](#)
- 2 Click [Settings/Registration] on the Portal page.** [▶Remote UI Screen\(P. 229\)](#)
- 3 Select [Device Management] ▶ [Key and Certificate Settings].**
- 4 Click [Generate Key].**

NOTE:

Deleting a registered key and certificate

- Click [Delete] on the right of the key and certificate you want to delete ▶ click [OK].
- A key and certificate cannot be deleted if it is currently used for some purpose, such as when "[TLS]" or "[IEEE 802.1X]" is displayed under [Key Usage]. In this case, disable the function or replace the other key and certificate before deleting it.

- 5 Select [Network Communication] and click [OK].**
- 6 Specify settings for the key and certificate.**

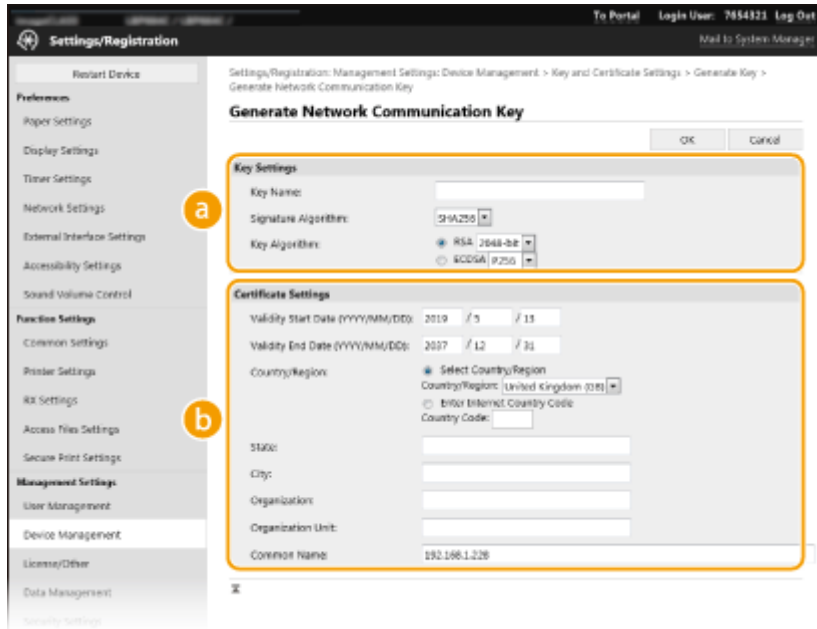

a [Key Settings]

[Key Name]

Enter alphanumeric characters for naming the key. Set a name that will be easy for you to find later in a list.

[Signature Algorithm]

Select the signature algorithm from the drop-down list.

[Key Algorithm]

Select the key generation algorithm from [RSA] or [ECDSA], then select the key length from the drop-down list. In either case, the larger the number for the key length is, the higher the security level becomes. However, the communication speed becomes slower.

NOTE:

- When [SHA384] or [SHA512] is selected in [Signature Algorithm], [512-bit] cannot be selected as the key length when [RSA] is selected in [Key Algorithm].

b [Certificate Settings]

[Validity Start Date (YYYY/MM/DD)]

Enter the validity start date of the certificate, in the order of: year, month, day.

[Validity End Date (YYYY/MM/DD)]

Enter the validity end date of the certificate, in the order of: year, month, day. A date earlier than [Validity Start Date (YYYY/MM/DD)] cannot be set.

[Country/Region]

Click the [Select Country/Region] radio button and select the country/region from the drop-down list. You can also click the [Enter Internet Country Code] radio button and enter a country code, such as "US" for the United States.

[State]/[City]

Enter alphanumeric characters for the location as necessary.

[Organization]/[Organization Unit]

Enter alphanumeric characters for the organization name as necessary.

[Common Name]

Enter alphanumeric characters for the common name of the certificate as necessary. "Common Name" is often abbreviated as "CN."

7 Click [OK].

- Generating a key and certificate may take some time.
- After the key and certificate is generated, it is automatically registered to the machine.

LINKS

- ▶ **Registering the Key and Certificate for Network Communication(P. 207)**
- ▶ **Configuring the Key and Certificate for TLS(P. 195)**
- ▶ **Configuring IPSec Settings(P. 209)**

Configuring the Expiration Check Method for Received Certificates

7YX2-04C

You can verify whether the certificate received from the other party during communication is valid by sending a query to the OCSP (online certificate status protocol) responder (a server that supports OCSP). Configure the certificate verification level and the OCSP responder to connect to. These should be registered by the administrator.

- 1 Start the Remote UI and log in to System Manager Mode. ▶ Starting Remote UI(P. 228)
- 2 Click [Settings/Registration] on the Portal page. ▶ Remote UI Screen(P. 229)
- 3 Select [Device Management] ▶ [OCSP (Online Certificate Status Protocol) Settings].
- 4 Click [Edit].
- 5 Select the check box for [Use OCSP (Online Certificate Status Protocol)], and configure the online certificate status protocol (OCSP).

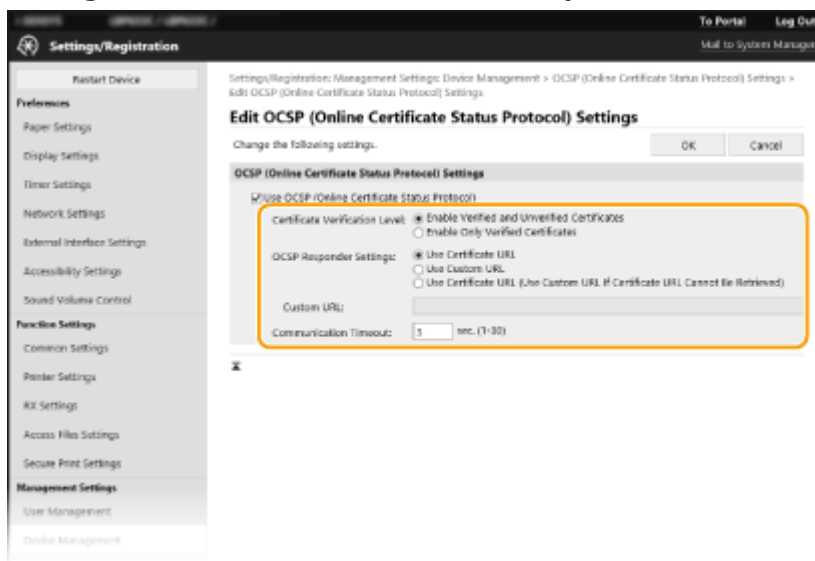

[Certificate Verification Level]

Set whether to disable certificates in situations such as the following:

- When the machine cannot connect to the OCSP responder
- When a timeout occurs
- When expiration cannot be checked, such as when the result of checking the expiration of a certificate via the OCSP responder is unknown

[OCSP Responder Settings]

Specify the URL for connecting to the OCSP responder.

[Custom URL]

When [Use Custom URL] or [Use Certificate URL (Use Custom URL If Certificate URL Cannot Be Retrieved)] is selected, enter the URL of the OCSP responder (ASCII code only, maximum 255 characters).

[Communication Timeout]

Set the time until communication with the OCSP responder times out. The connection is canceled if there is no response from the OCSP responder within the set time.

6 Click [OK].

Generating a Key and Certificate Signing Request (CSR)

7YX2-04E

Because certificates generated on the machine do not have a CA signature, a communication error may result depending on devices it communicates with. To have the certificate authority issue the certificate with the CA signature, you need to obtain data of CSR (Certificate Signing Request), which the administrator can generate from Remote UI. When the certificate is issued, register it in the key with the CSR generated.

▶ **Generating a Key and CSR(P. 204)**

▶ **Registering a Certificate to a Key(P. 206)**

NOTE

- For more information about the basic operations to be performed when setting the machine from the Remote UI, see ▶ **Setting Up Menu Options from Remote UI(P. 237)** .

Generating a Key and CSR

- 1 Start the Remote UI and log in to System Manager Mode. ▶ Starting Remote UI(P. 228)**
- 2 Click [Settings/Registration] on the Portal page. ▶ Remote UI Screen(P. 229)**
- 3 Select [Device Management] ▶ [Key and Certificate Settings].**
- 4 Click [Generate Key].**

NOTE:

Deleting a registered key and certificate

- Click [Delete] on the right of the key and certificate you want to delete ▶ click [OK].
- A key and certificate cannot be deleted if it is currently used for some purpose, such as when "[TLS]" or "[IEEE 802.1X]" is displayed under [Key Usage]. In this case, disable the function or replace the key and certificate before deleting it.

- 5 Select [Key and Certificate Signing Request (CSR)] and click [OK].**
- 6 Specify settings for the key and CSR.**

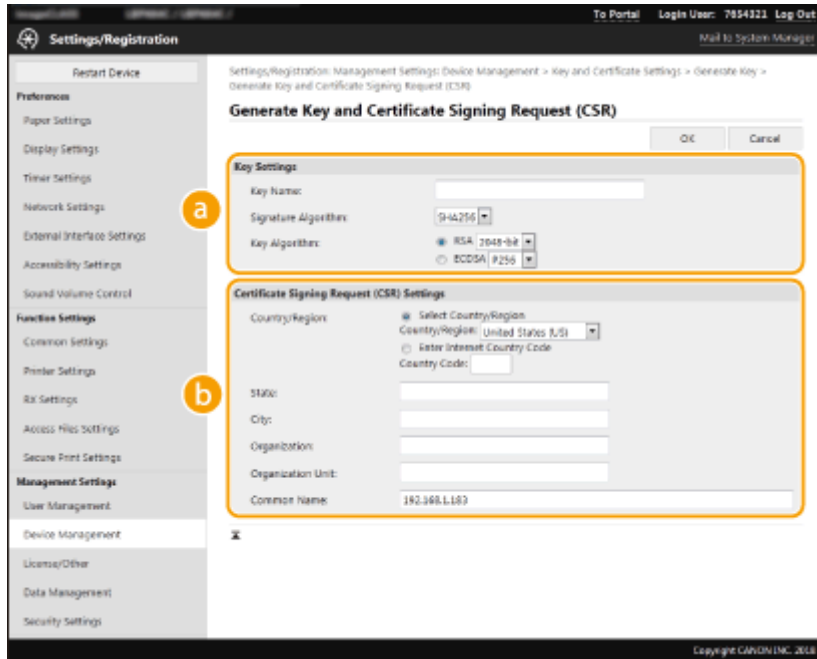

a [Key Settings]

[Key Name]

Enter alphanumeric characters for naming the key. Set a name that will be easy for you to find later in a list.

[Signature Algorithm]

Select the signature algorithm from the drop-down list.

[Key Algorithm]

Select the key generation algorithm from [RSA] or [ECDSA], then select the key length from the drop-down list. In any case, the larger the number for the key length, the slower the communication. However, the security is tighter.

NOTE:

- When [SHA384] or [SHA512] is selected in [Signature Algorithm], [512-bit] cannot be selected as the key length when [RSA] is selected in [Key Algorithm].

b [Certificate Signing Request (CSR) Settings]

[Country/Region]

Click the [Select Country/Region] radio button and select the country/region from the drop-down list. You can also click the [Enter Internet Country Code] radio button and enter a country code, such as "US" for the United States.

[State]/[City]

Enter alphanumeric characters for the location as necessary.

[Organization]/[Organization Unit]

Enter alphanumeric characters for the organization name as necessary.

[Common Name]

Enter alphanumeric characters for the common name of the certificate as necessary. "Common Name" is often abbreviated as "CN."

7 Click [OK].

- Generating a key and CSR may take some time.

8 Click [Store in File].

- A dialog box for storing the file appears. Choose where to store the file and click [Save].
 ⇒ The CSR file is stored on the computer.

9 Attach the stored file and submit the application to the certification authority.

Registering a Certificate to a Key

The key with the CSR generated cannot be used until the certificate issued from the certificate authority based on the CSR is registered in the key. Once the certification authority has issued the certificate, register it using the procedure below.

1 Start the Remote UI and log in to System Manager Mode. ▶Starting Remote UI(P. 228)

2 Click [Settings/Registration] on the Portal page. ▶Remote UI Screen(P. 229)

3 Select [Device Management] ▶ [Key and Certificate Settings].

4 Click [Key Name] or [Certificate] required to register the certificate.

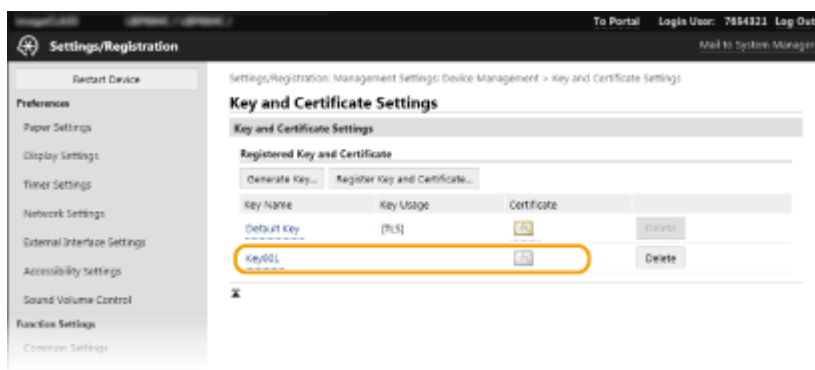

5 Click [Register Certificate].

6 Click [Browse], specify the file for the certificate signing request, and click [Register].

LINKS

- ▶Configuring the Key and Certificate for TLS(P. 195)
- ▶Generating the Key and Certificate for Network Communication(P. 199)
- ▶Registering the Key and Certificate for Network Communication(P. 207)
- ▶Configuring IPsec Settings(P. 209)

Registering the Key and Certificate for Network Communication

7YX2-04F

You can obtain the key and certificate, and the CA certificate from a certification authority (CA) for use with the machine. Install and register the obtained key and certificate file and CA certificate file in this machine using Remote UI. Check the key and certificate, and CA certificate conditions that are required for the machine in advance ([▶ Management Functions\(P. 385\)](#)).



NOTE

- For more information about the basic operations to be performed when setting the machine from the Remote UI, see [▶Setting Up Menu Options from Remote UI\(P. 237\)](#) .

1 Start the Remote UI and log in to System Manager Mode. [▶Starting Remote UI\(P. 228\)](#)

2 Click [Settings/Registration] on the Portal page. [▶Remote UI Screen\(P. 229\)](#)

3 Select [Device Management] ▶ [Key and Certificate Settings] or [CA Certificate Settings].

- Click [Key and Certificate Settings] to install a key and certificate, or [CA Certificate Settings] to install a CA certificate.

4 Click [Register Key and Certificate] or [Register CA Certificate].

NOTE:

Deleting a registered key and certificate or CA certificate

- Click [Delete] on the right of the key and certificate or CA certificate you want to delete ▶ click [OK]. You cannot delete the preinstalled CA certificates.
- A key and certificate cannot be deleted if it is currently used for some purpose, such as when "[TLS]" or "[IEEE 802.1X]" is displayed under [Key Usage]. In this case, disable the function or replace the key and certificate before deleting it.

Disabling or enabling the preinstalled CA certificates

- Click [Disable] on the right of the preinstalled CA certificate you want to disable. To enable the certificate again, click [Enable] on the right of the certificate.

5 Click [Install].

NOTE:**Deleting the key and certificate file or CA certificate file**

- Click [Delete] on the right of the file you want to delete ► click [OK].

6 Click [Browse], specify the file to install, and click [Start Installation].

► The key and certificate file or the CA certificate file is installed on the machine from a computer.

7 Register the key and certificate or CA certificate.**■ Registering a key and certificate**

- 1 Click [Register] on the right of the key and certificate file you want to register.
- 2 Enter the name of the key and password.

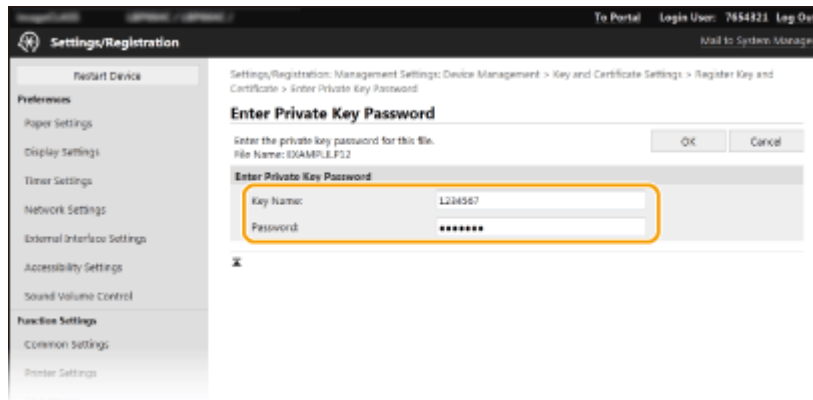
**[Key Name]**

Enter alphanumeric characters for the name of the key to be registered.

[Password]

Enter alphanumeric characters for the password of the private key set for the file to be registered.

- 3 Click [OK].

■ Registering a CA certificate

Click [Register] on the right of the CA certificate file you want to register.

LINKS

- ▶ **Generating the Key and Certificate for Network Communication(P. 199)**
- ▶ **Configuring the Key and Certificate for TLS(P. 195)**
- ▶ **Configuring IPSec Settings(P. 209)**
- ▶ **Configuring IEEE 802.1X Authentication Settings(P. 216)**

Configuring IPsec Settings

7YX2-04H

Internet Protocol Security (IPsec or IPsec) is a protocol suite for encrypting data transported over a network, including Internet networks. While TLS only encrypts data used on a specific application, such as a Web browser or an e-mail application, IPsec encrypts either whole IP packets or the payloads of IP packets, offering a more versatile security system. The IPsec of the machine works in transport mode, in which the payloads of IP packets are encrypted. With this feature, the machine can connect directly to a computer that is in the same virtual private network (VPN). Check the system requirements ([▶Management Functions\(P. 385\)](#)) and set the necessary configuration on the computer before you configure the machine.

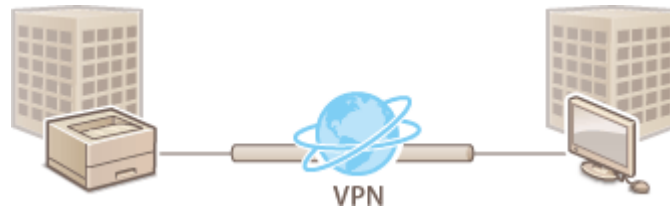

NOTE

Using IPsec with IP address filter

- IP address filter settings are applied before the IPsec policies. [▶Specifying IP Addresses for Firewall Settings\(P. 186\)](#)

Configuring IPsec Settings

Before using IPsec for encrypted communication, you need to register security policies (SP). A security policy consists of the groups of settings described below. After registering policies, specify the order in which they are applied.

Selector

Selector defines conditions for IP packets to apply IPsec communication. Selectable conditions include IP addresses and port numbers of the machine and the devices to communicate with.

IKE

IKE configures the IKEv1 that is used for key exchange protocol. Note that instructions vary depending on the authentication method selected.

[Pre-Shared Key Method]

This authentication method uses a common key word, called Shared Key, for communication between the machine and other devices. Enable TLS for the Remote UI before specifying this authentication method ([▶Configuring the Key and Certificate for TLS\(P. 195\)](#)).

[Digital Signature Method]

The machine and the other devices authenticate each other by mutually verifying their digital signatures. Generate or install the key and certificate beforehand ([▶Registering the Key and Certificate for Network Communication\(P. 207\)](#)).

AH/ESP

Specify the settings for AH/ESP, which is added to packets during IPsec communication. AH and ESP can be used at the same time. You can also select whether or not to enable PFS for tighter security.

NOTE

- For more information about the basic operations to be performed when setting the machine from the Remote UI, see [▶Setting Up Menu Options from Remote UI\(P. 237\)](#) .

1 Start the Remote UI and log in to System Manager Mode. ▶Starting Remote UI(P. 228)

2 Click [Settings/Registration] on the Portal page. ▶Remote UI Screen(P. 229)

3 Select [Network Settings] ▶ [IPSec Settings].

4 Click [Edit].

5 Select the [Use IPSec] check box and click [OK].

- If you want the machine to only receive packets that match one of the security policies that you define in the steps below, clear the [Receive Non-Policy Packets] check box.

6 Click [Register New Policy].

7 Specify the Policy Settings.

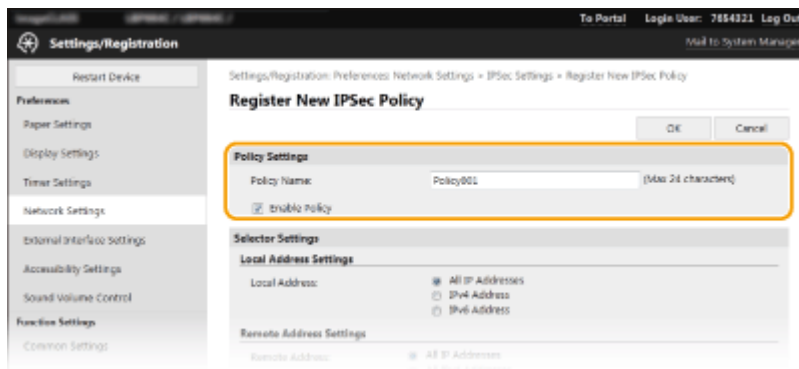

1 In the [Policy Name] text box, enter alphanumeric characters for a name that is used for identifying the policy.

2 Select the [Enable Policy] check box.

8 Specify the Selector Settings.

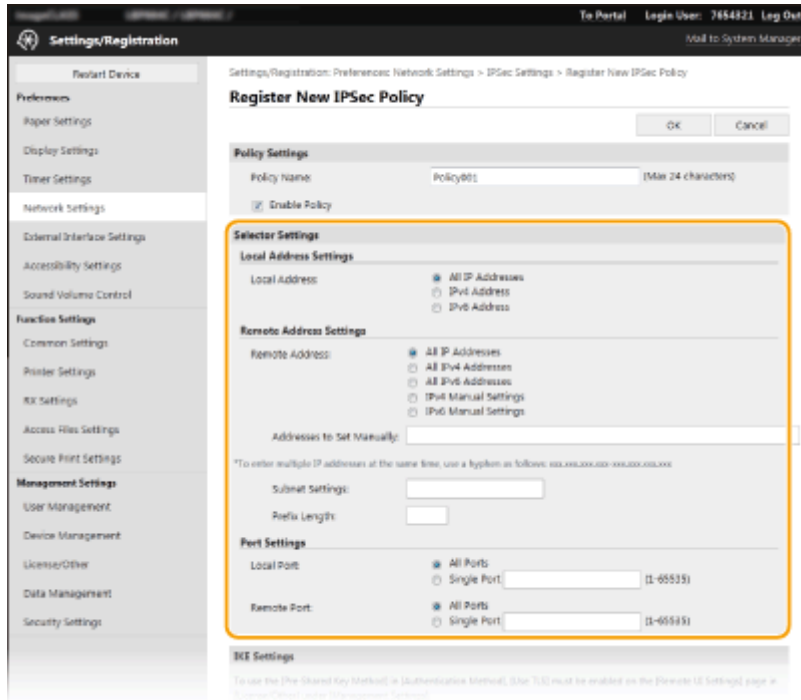

[Local Address]

Click the radio button for the type of IP address of the machine to apply the policy.

[All IP Addresses]	Select to use IPSec for all IP packets.
[IPv4 Address]	Select to use IPSec for all IP packets that are sent to or from the IPv4 address of the machine.
[IPv6 Address]	Select to use IPSec for all IP packets that are sent to or from an IPv6 address of the machine.

[Remote Address]

Click the radio button for the type of IP address of the other devices to apply the policy.

[All IP Addresses]	Select to use IPSec for all IP packets.
[All IPv4 Addresses]	Select to use IPSec for all IP packets that are sent to or from IPv4 addresses of the other devices.
[All IPv6 Addresses]	Select to use IPSec for all IP packets that are sent to or from IPv6 addresses of the other devices.
[IPv4 Manual Settings]	Select to specify a single IPv4 address or a range of IPv4 addresses to apply IPSec. Enter the IPv4 address (or the range) in the [Addresses to Set Manually] text box.
[IPv6 Manual Settings]	Select to specify a single IPv6 address or a range of IPv6 addresses to apply IPSec. Enter the IPv6 address (or the range) in the [Addresses to Set Manually] text box.

[Addresses to Set Manually]

If [IPv4 Manual Settings] or [IPv6 Manual Settings] is selected for [Remote Address], enter the IP address to apply the policy. You can also enter a range of addresses by inserting a hyphen between the addresses.

NOTE:

Entering IP addresses

	Description	Example
Entering a single address	IPv4: Delimit numbers with periods.	192.168.0.10
	IPv6: Delimit alphanumeric characters with colons.	fe80::10
Specifying a range of addresses	Insert a hyphen between the addresses.	192.168.0.10-192.168.0.20

[Subnet Settings]

When manually specifying IPv4 address, you can express the range by using the subnet mask. Enter the subnet mask using periods to delimit numbers (example:"255.255.255.240").

[Prefix Length]

Specifying the range of IPv6 addresses manually also allows you to specify the range using prefixes. Enter a range between 0 and 128 as the prefix length.

[Local Port]/[Remote Port]

If you want to create separate policies for each protocol, such as HTTP or WSD, click the [Single Port] radio button and enter the appropriate port number for the protocol to determine whether to use IPSec.

! IMPORTANT:

IPSec is not applied to the following packets

- Loopback, multicast, and broadcast packets
- IKE packets (using UDP on port 500)
- ICMPv6 neighbor solicitation and neighbor advertisement packets

9 Specify the IKE Settings.

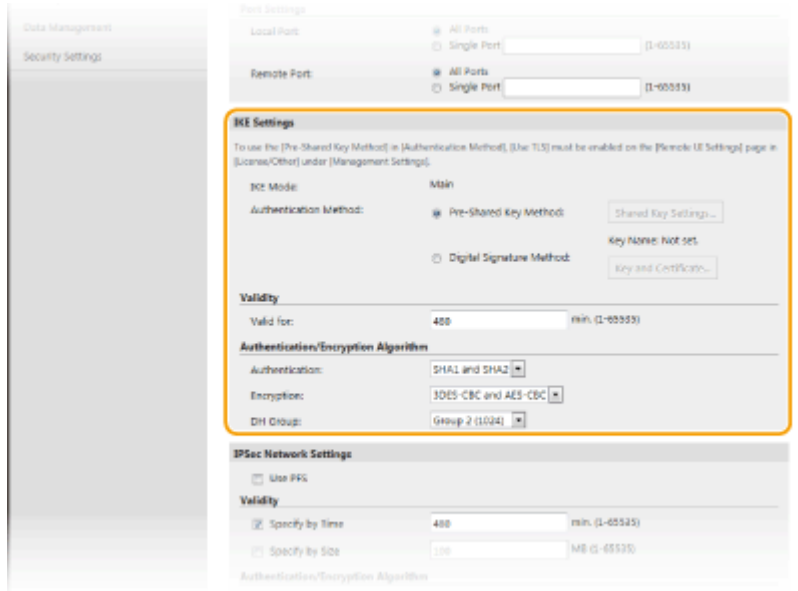

[IKE Mode]

The mode used for the key exchange protocol is displayed. The machine supports the main mode, not the aggressive mode.

[Authentication Method]

Select [Pre-Shared Key Method] or [Digital Signature Method] for the method used when authenticating the machine. You need to enable TLS for the Remote UI before selecting [Pre-Shared Key Method]. You need to generate or install the key and certificate before selecting [Digital Signature Method]. **➡Configuring the Key and Certificate for TLS(P. 195)**

[Valid for]

Specify how long a session lasts for IKE SA (ISAKMP SA). Enter the time in minutes.

[Authentication]/[Encryption]/[DH Group]

Select an algorithm from the drop-down list. Each algorithm is used in the key exchange.

[Authentication]	Select the hash algorithm.
[Encryption]	Select the encryption algorithm.
[DH Group]	Select the Diffie-Hellman group, which determines the key strength.

■ **Authenticating a machine using a pre-shared key**

- 1 Click the [Pre-Shared Key Method] radio button for [Authentication Method] and then click [Shared Key Settings].
- 2 Enter alphanumeric characters for the pre-shared key and click [OK].
- 3 Specify the [Valid for] and [Authentication]/[Encryption]/[DH Group] settings.

■ **Authenticating a machine using digital signature method**

- 1 Click the [Digital Signature Method] radio button for [Authentication Method] and then click [Key and Certificate].
- 2 Click [Register Default Key] on the right of the key and certificate you want to use.

NOTE:

Viewing details of a certificate

- You can check the details of the certificate or verify the certificate by clicking the corresponding text link under [Key Name], or the certificate icon.
- 3 Specify the [Valid for] and [Authentication]/[Encryption]/[DH Group] settings.

10 Specify the IPSec Network Settings.

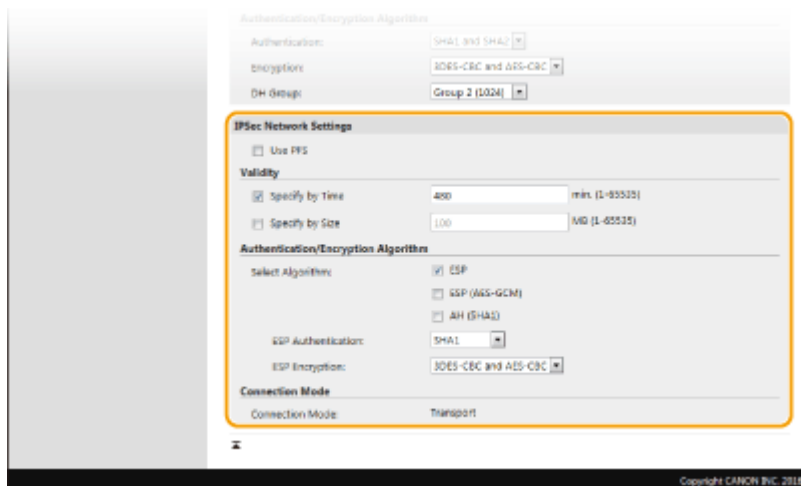

[Use PFS]

Select the check box to enable Perfect Forward Secrecy (PFS) for IPSec session keys. Enabling PFS enhances the security while increasing the load on the communication. Make sure that PFS is also enabled for the other devices.

[Specify by Time]/[Specify by Size]

Set the conditions for terminating a session for IPSec SA. IPSec SA is used as a communication tunnel. Select either or both of the check boxes as necessary. If both check boxes are selected, the IPSec SA session is terminated when either of the conditions has been satisfied.

[Specify by Time]	Enter a time in minutes to specify how long a session lasts.
[Specify by Size]	Enter a size in megabytes to specify how much data can be transported in a session.

[Select Algorithm]

Select the [ESP], [ESP (AES-GCM)], or [AH (SHA1)] check box(es) depending on the IPSec header and the algorithm used. AES-GCM is an algorithm for both authentication and encryption. If [ESP] is selected, also select algorithms for authentication and encryption from the [ESP Authentication] and [ESP Encryption] drop-down lists.

[ESP Authentication]	To enable the ESP authentication, select [SHA1] for the hash algorithm. Select [Do Not Use] if you want to disable the ESP authentication.
[ESP Encryption]	Select the encryption algorithm for ESP. You can select [NULL] if you do not want to specify the algorithm, or select [Do Not Use] if you want to disable the ESP encryption.

[Connection Mode]

The connection mode of IPSec is displayed. The machine supports transport mode, in which the payloads of IP packets are encrypted. Tunnel mode, in which whole IP packets (headers and payloads) are encapsulated is not available.

11 Click [OK].

- If you need to register an additional security policy, return to step 6.

12 Arrange the order of policies listed under [Registered IPSec Policies].

- Policies are applied from one at the highest position to the lowest. Click [Up] or [Down] to move a policy up or down the order.

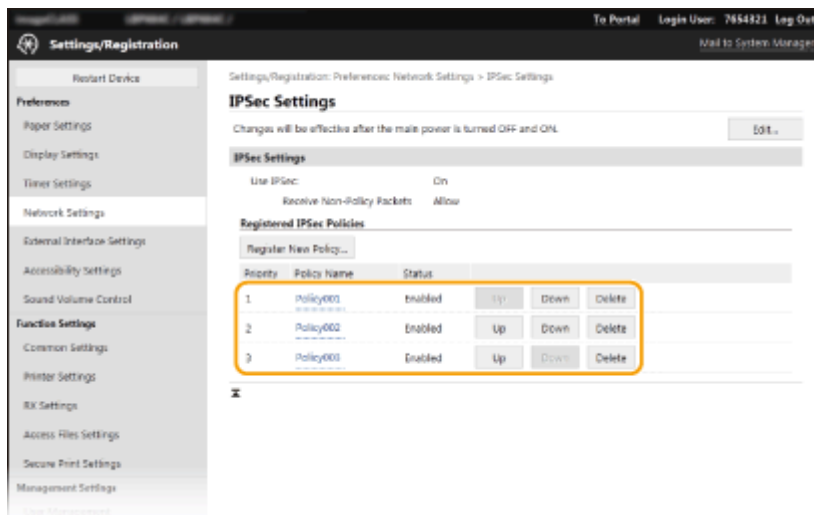

NOTE:

Editing a policy

- Click the corresponding text link under [Policy Name] for the edit screen.

Deleting a policy

- Click [Delete] on the right of the policy name you want to delete ► click [OK].



13 Restart the machine. ▶ Restarting the Machine(P. 87)

NOTE

Using the operation panel

- You can also enable or disable IPSec communication from <Menu> in the Home screen.  **<Use IPSec>(P. 275)**

LINKS

-  **Configuring the Key and Certificate for TLS(P. 195)**
-  **IPSec Policy List(P. 361)**

Configuring IEEE 802.1X Authentication Settings

7YX2-04J

The machine can connect to an 802.1X network as a client device. A typical 802.1X network consists of a RADIUS server (authentication server), LAN switch (authenticator), and client devices with authentication software (supplicants). If a device tries to connect to the 802.1X network, the device must go through user authentication in order to prove that the connection is made by an authorized user. Authentication information is sent to and checked by a RADIUS server, which permits or rejects communication to the network depending on the authentication result. If authentication fails, a LAN switch (or an access point) blocks access from the outside of the network.

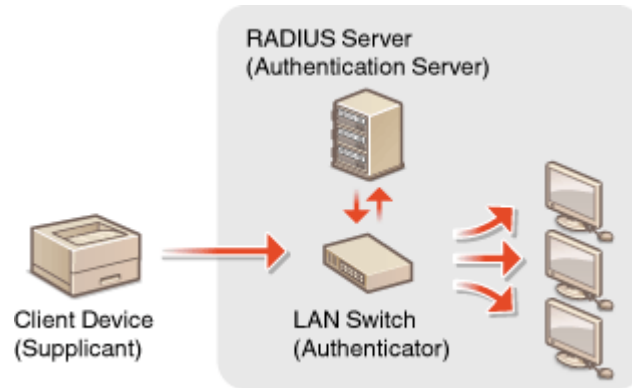

IEEE 802.1X Authentication Method

Select the authentication method from the options below. If necessary, install or register a key and certificate or a CA certificate before configuring IEEE 802.1X authentication ([▶Registering the Key and Certificate for Network Communication\(P. 207\)](#)).

■ TLS

The machine and the authentication server authenticate each other by mutually verifying their certificates. A key and certificate issued by a certification authority (CA) is required for the client authentication (when authenticating the machine). For the server authentication, a CA certificate installed via the Remote UI can be used in addition to a CA certificate preinstalled in the machine.

■ TTLS

This authentication method uses a user name and password for the client authentication and a CA certificate for the server authentication. MSCHAPv2 or PAP can be selected as the internal protocol. TTLS can be used with PEAP at the same time. Enable TLS for the Remote UI before configuring this authentication method ([▶Configuring the Key and Certificate for TLS\(P. 195\)](#)).

■ PEAP

The required settings are almost the same as those of TTLS. MSCHAPv2 is used as the internal protocol. Enable TLS for the Remote UI before configuring this authentication method ([▶Configuring the Key and Certificate for TLS\(P. 195\)](#)).

NOTE

- For more information about the basic operations to be performed when setting the machine from the Remote UI, see [▶Setting Up Menu Options from Remote UI\(P. 237\)](#) .

- 1 Start the Remote UI and log in to System Manager Mode. [▶Starting Remote UI\(P. 228\)](#)

2 Click [Settings/Registration] on the Portal page. ▶ Remote UI Screen(P. 229)

3 Select [Network Settings] ▶ [IEEE 802.1X Settings].

4 Click [Edit].

5 Select the [Use IEEE 802.1X] check box, and enter the login name in the [Login Name] text box.

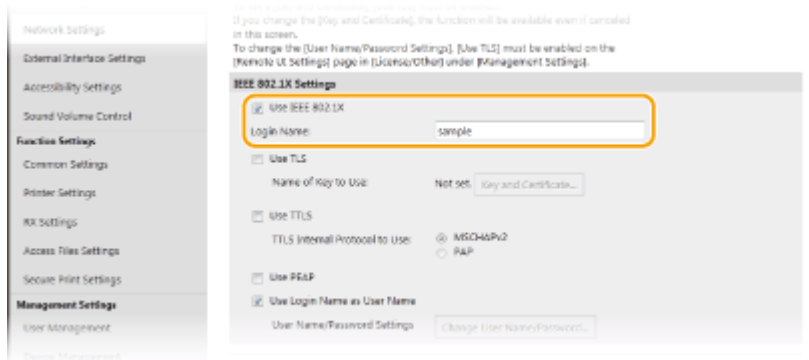

[Use IEEE 802.1X]

Select the check box to enable IEEE 802.1X authentication.

[Login Name]

Enter alphanumeric characters for a name (EAP identity) that is used for identifying the user.

6 Configure the required settings according to the specified authentication method.



■ Setting TLS

1 Select the [Use TLS] check box and click [Key and Certificate].

- You cannot use TLS with TTLS or PEAP.

2 Click [Register Default Key] on the right of the key and certificate you want to use for the client authentication.

NOTE:

Viewing details of a certificate

- You can check the details of the certificate or verify the certificate by clicking the corresponding text link under [Key Name], or the certificate icon.

■ Setting TTLS/PEAP

- 1 Select the [Use TTLS] or [Use PEAP] check box.

NOTE:

Internal protocol for TTLS

- You can select MSCHAPv2 or PAP.



- 2 Click [Change User Name/Password].

- To specify a user name other than the login name, clear the [Use Login Name as User Name] check box. Select the check box if you want to use the login name as the user name.

- 3 Set the user name/password.

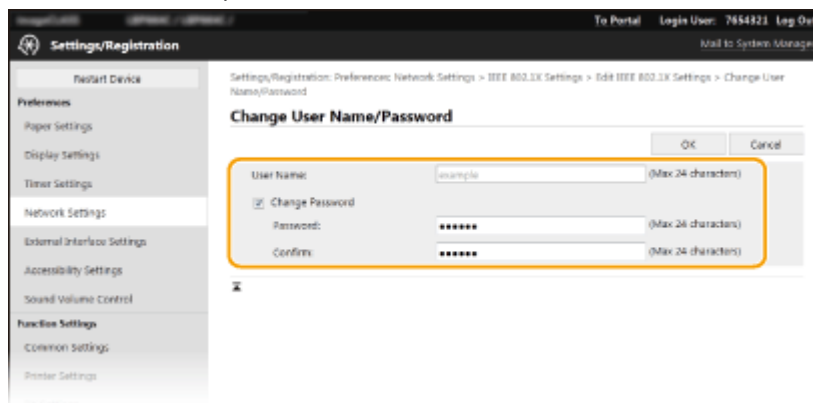

[User Name]

Enter alphanumeric characters for the user name.

[Change Password]

To set or change the password, select the check box and enter alphanumeric characters for the new password both in the [Password] and [Confirm] text boxes.

- 4 Click [OK].

- 7 Click [OK].

- 8 Restart the machine. ▶ **Restarting the Machine(P. 87)**

NOTE

Using the operation panel

- You can also enable or disable IEEE 802.1X authentication from <Menu> in the Home screen. ▶ **<IEEE 802.1X Settings>(P. 278)**

LINKS

▶ **Configuring the Key and Certificate for TLS(P. 195)**

Restricting the Machine's Functions

7YX2-04K

Some of the functions of the machine may rarely be used or provide opportunities for misuse. For security purposes, the machine can be set to limit its capabilities by partially or completely disabling these functions.

Restricting Printing from a Computer

You can limit "printing from computer" only to secure documents so that no print jobs can be executed unless the PIN is entered on the machine side. [▶Restricting Printing from a Computer\(P. 222\)](#)



Restricting USB Functions

The USB connection allows an easy connection with peripheral devices, but it may cause a security risk such as an information leakage. You can restrict a USB connection with a computer. [▶Restricting USB Functions\(P. 223\)](#)



Disabling HTTP Communication

When not performing operations via the network, for example, when using the machine via USB connection, you can disable HTTP communication to prevent a hacking via the HTTP port. [▶Disabling HTTP Communication\(P. 224\)](#)



Disabling Remote Management

When not using Remote UI, you can disable functions to prevent an unauthorized remote operation via Remote UI. [▶Disabling Remote UI\(P. 225\)](#)



Restricting Use of the Operation Panel

You can protect the machine settings from inadvertent changes by restricting use of the keys on the operation panel. [▶Restricting Use of the Operation Panel\(P. 226\)](#)



Restricting Printing from a Computer

7YX2-04L

You can drastically reduce information leakage risks by limiting the documents printable from a computer to the Secure Print documents (▶ **Printing a Document Secured by a PIN (Secure Print)(P. 143)**).



<Menu> ▶ <Function Settings> ▶ <Secure Print> ▶ <Restrict Printer Jobs> ▶ <On> ▶ 

Restricting USB Functions

7YX2-04R

USB is a convenient way of connecting peripheral devices and storing or relocating data, but USB can also be a source of information leakage if it is not properly managed. This section describes how to restrict connection via the USB port of the machine.



Restricting the USB Connection with a Computer(P. 223)

Restricting the USB Connection with a Computer

You can disable the computer connection USB port located on the back side of the machine. If this port is disabled, the machine cannot communicate with a computer via USB.



<Menu> ▶ <Preferences> ▶ <External Interface> ▶ <USB Settings> ▶ <Use as USB Device> ▶ <Off>
▶ Restart the machine

Disabling HTTP Communication

7YX2-04S

HTTP is used for communications over the network, such as when you access the machine via the Remote UI. If you are using a USB connection or are otherwise not using HTTP, you can disable HTTP to block malicious third-party intrusions via the unused HTTP port.



! IMPORTANT

- Disabling HTTP disables some of the network capabilities, such as the Remote UI and WSD printing.



<Menu> ▶ <Preferences> ▶ <Network> ▶ <TCP/IP Settings> ▶ <Use HTTP> ▶ <Off> ▶ <Yes> ▶ 

LINKS

- ▶ [Managing the Machine from a Computer \(Remote UI\)\(P. 227\)](#)
- ▶ [Changing Port Numbers\(P. 192\)](#)
- ▶ [Configuring Printing Protocols and WSD Functions\(P. 37\)](#)

Disabling Remote UI

7YX2-04U

The Remote UI is useful because the machine settings can be specified by using a Web browser on a computer. To use the Remote UI, the machine must be connected to a computer over the network. If the machine is connected to a computer via USB, or if you do not need to use the Remote UI, you might want to disable the Remote UI to reduce the risk of having your machine controlled remotely over the network by malicious third parties.



<Menu> ▶ <Management Settings> ▶ <Remote UI Settings/Update Firmware> ▶ <Remote UI Settings> ▶ <Use Remote UI> ▶ <Off> ▶ Restart the machine

LINKS

- ▶ [Managing the Machine from a Computer \(Remote UI\)\(P. 227\)](#)
- ▶ [Disabling HTTP Communication\(P. 224\)](#)

Restricting Use of the Operation Panel

7YX2-04W

You can protect the machine settings from inadvertent changes by restricting use of the keys on the operation panel.

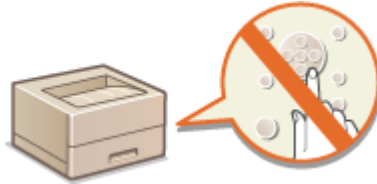

NOTE

- For more information about the basic operations to be performed when setting the machine from the Remote UI, see [▶Setting Up Menu Options from Remote UI\(P. 237\)](#) .

- 1 Start the Remote UI and log in to System Manager Mode. ▶Starting Remote UI(P. 228)**
- 2 Click [Settings/Registration] on the Portal page. ▶Remote UI Screen(P. 229)**
- 3 Select [Device Management] ▶ [Key Lock Settings].**
- 4 Click [Edit].**
- 5 Select the [Enable Key Lock] check box ▶ [OK].**

NOTE

- Even when the keylock function is activated, the following keys can be used.
 - Home key
 - Back key
 - Energy Saver key
 - Stop key

Managing the Machine from a Computer (Remote UI)

7YX2-04X

Using a Web browser to operate the machine remotely, you can check the documents waiting to be printed or the status of the machine. You can also make various settings. You can do this without leaving your desk, making system management easier. For more information about the system requirements for the Remote UI, see **System Environment(P. 387)** .

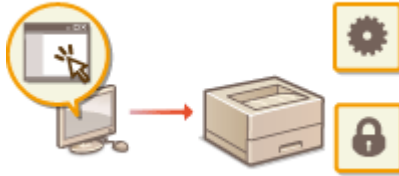

Functions of the Remote UI

- ▶ **Checking the Status and Logs(P. 231)**
- ▶ **Setting Up Menu Options from Remote UI(P. 237)**
- ▶ **Security Policy(P. 240)**
- ▶ **Importing/Exporting the Setting Data(P. 245)**

Basics of the Remote UI

- ▶ **Starting Remote UI(P. 228)**

Starting Remote UI

7YX2-04Y

To operate remotely, you need to input the IP address of the machine into a Web browser and start the Remote UI. Check the IP address set to the machine in advance ([▶Viewing Network Settings\(P. 34\)](#)). If you have any questions, ask your Network Administrator.

1 Start the Web browser.

2 Enter "http://<the IP address of the machine>/" in the address field, and press the [ENTER] key.

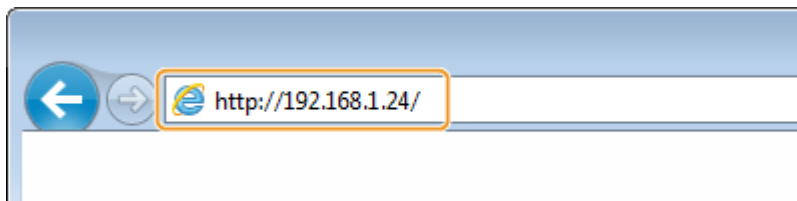

- If you want to use an IPv6 address, enclose the IPv6 address with brackets (example: http://[fe80::2e9e:fcff:fe4e:dbce]/).

NOTE:

If a security alert is displayed

- A security alert may be displayed when the Remote UI communication is encrypted ([▶Configuring the Key and Certificate for TLS\(P. 195\)](#)). When certificate settings or TLS settings have no errors, continue browsing the Web site.

3 Log in to the Remote UI.

■When the Department ID Management is disabled

Select [System Manager Mode] or [General User Mode], and enter a value in [Remote UI Access PIN] as necessary.

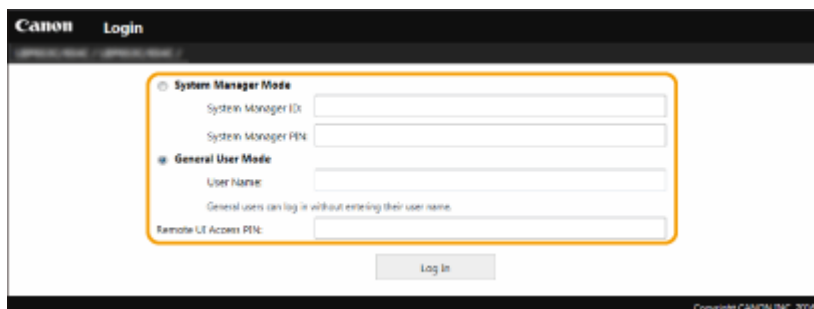

[System Manager Mode]

You can perform all the Remote UI operations and settings. Enter the appropriate ID in [System Manager ID] and PIN in [System Manager PIN]. [▶Setting the System Manager ID and PIN\(P. 173\)](#)

[General User Mode]

You can check the status of documents or the machine, and you can also change some of the settings. When you want to check if a specific document of yours is in the print queue or cancel the printing of a document of yours in the print queue, enter the user name of the document in [User Name]. The user name is automatically set to print documents based on information such as your computer name or computer login name.

[Remote UI Access PIN]

If [Remote UI Access PIN] is set, enter the PIN. **▶Setting a Remote UI PIN(P. 181)**

■When the Department ID Management is enabled

Enter the appropriate ID in [Department ID] and PIN in [PIN]. **▶Setting the Department ID Management(P. 175)**

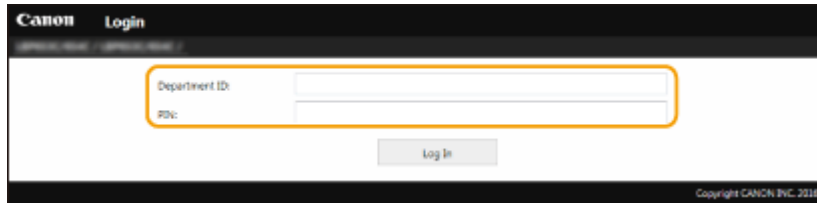

4 Click [Log In].

➡ The Portal page (main page) will be displayed. **▶Remote UI Screen(P. 229)**

Setting the Timeout Time after Logging In to the Remote UI

The user is automatically logged out if no operations are performed for a certain period of time after logging in to the Remote UI. You can set the time until the user is logged out.



Log in to the Remote UI ▶ [Settings/Registration] ▶ [Network Settings] ▶ [Session Settings] ▶ [Edit] ▶ Set [Timeout After Logging in to Remote UI] ▶ [OK]

Remote UI Screen

When you log in to the Remote UI, the following Portal page appears. This section describes the items displayed on the Portal page and the basic operations.

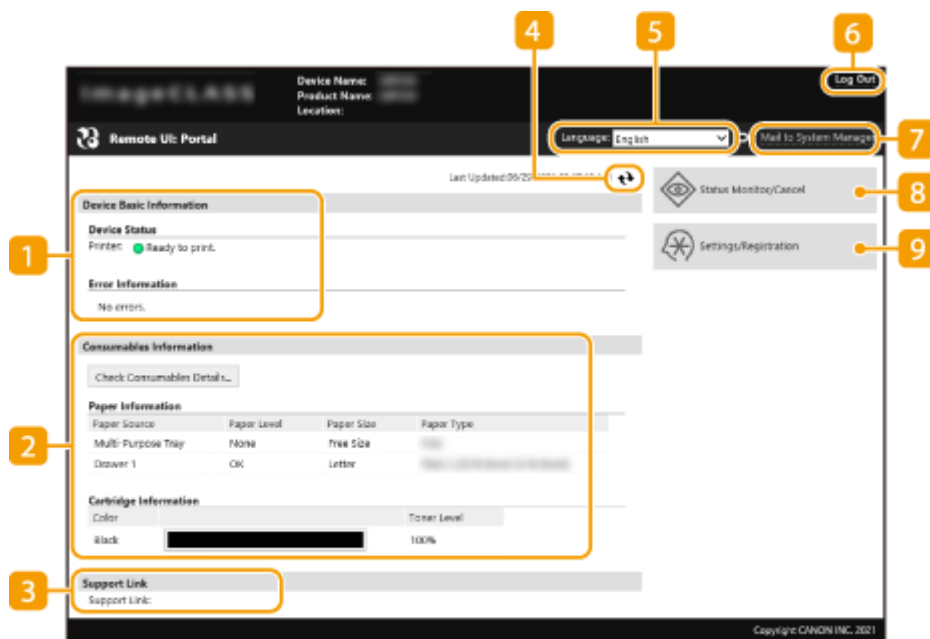

1 [Device Basic Information]

Displays the current status of the machine and error information. If an error has occurred, the link to the Error Information page will be displayed.

2 [Consumables Information]

Displays paper information and the amount remaining in the toner cartridges.

3 [Support Link]

Displays the support link specified in [Support Link] under [License/Other].

4 Refresh Icon

Refreshes the currently displayed page.

5 [Language]

Selects the display language used for the Remote UI screens.

6 [Log Out]

Logs off from the Remote UI. The Login page will be displayed.

7 [Mail to System Manager]

Displays a window for creating an e-mail to the system manager specified in [System Manager Information] under [User Management].

8 [Status Monitor/Cancel]

Displays the [Status Monitor/Cancel] page. For any of the waiting documents, you can check the status/history or cancel the processing.

9 [Settings/Registration]

Displays [Settings/Registration] page. When you have logged in to System Manager Mode, you can change the settings items and save/load the registered data. ▶ **Setting Up Menu Options from Remote UI(P. 237)**

Checking the Status and Logs

7YX2-050

- ▶ **Checking Current Status of Print Documents(P. 231)**
- ▶ **Checking Current Status of Received Documents(P. 232)**
- ▶ **Checking History of Documents(P. 232)**
- ▶ **Checking Error Information(P. 232)**
- ▶ **Checking Consumables(P. 233)**
- ▶ **Checking Device Specifications(P. 233)**
- ▶ **Checking System Manager Information(P. 234)**
- ▶ **Checking Print Total Counter(P. 234)**
- ▶ **Checking History of Toner Cartridges(P. 235)**
- ▶ **Checking Usage Status of the Machine(P. 235)**

NOTE

- A file name of a document may not be displayed in full. The printed application name may be added to the file name.

Checking Current Status of Print Documents

The list of the documents currently printing or waiting to be printed is displayed.



Log in to the Remote UI (▶ **Starting Remote UI(P. 228)**) ▶ [Status Monitor/Cancel] ▶ [[Job Status] in [Print]

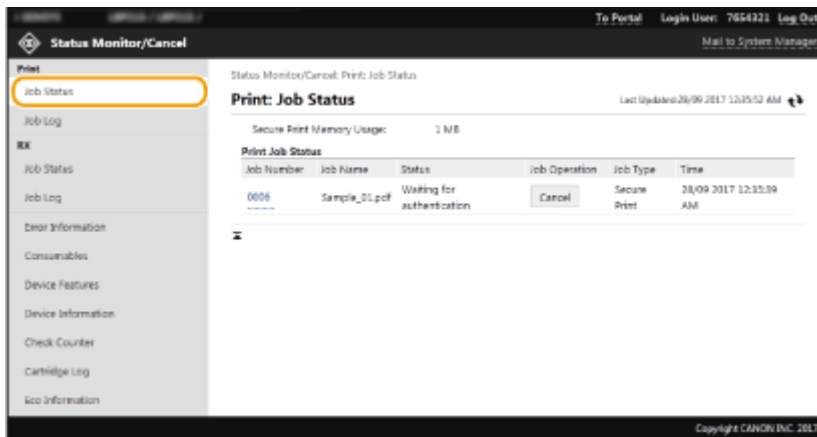

- You can delete a document job by clicking [Cancel].

NOTE

- Regardless of the Department ID Management setting, all the print documents currently printing and waiting to be printed will be listed.
- If you entered your user name when you logged on in General User Mode, your user name will only be displayed on the documents that you printed.

- Click [Job Number] on the paused documents and secure documents to display detailed information. You can check the user name and the page count of the printed document.

Checking Current Status of Received Documents

You can check the logs of received I-Fax documents.



Log in to the Remote UI (▶ **Starting Remote UI(P. 228)**) ▶ [Status Monitor/Cancel] ▶ [Job Status] in [RX]

Checking History of Documents

The job logs of print or receiving (RX) are displayed.



Log in to the Remote UI (▶ **Starting Remote UI(P. 228)**) ▶ [Status Monitor/Cancel] ▶ [Job Log]

The screenshot shows the 'Status Monitor/Cancel' interface. On the left, there is a navigation menu with 'Job Log' highlighted under both 'Print' and 'RX' sections. The main area displays the 'Print Job Log' table, which is updated as of 27/09 2017 09:08:02 PM. The table contains the following data:

Job Number	Result	Start Time	End Time	Job Type	File Name	User Name	Original Pages	Output Page
0005	error	27/09 2017 09:08:52 PM	27/09 2017 09:08:49 PM	Printer	sample.pdf	user	1	0
0002	OK	27/09 2017 09:00:09 PM	27/09 2017 09:00:31 PM	Printer	Full page photo	user	1	1
0001	OK	27/09 2017 08:57:18 PM	27/09 2017 08:57:50 PM	Printer	Sample.pdf	user	5	5

Checking Error Information

When an error occurs, this page will be displayed by clicking the message displayed under [Error Information] on the Portal page (main page). ▶ **Remote UI Screen(P. 229)**



Log in to the Remote UI (▶ **Starting Remote UI(P. 228)**) ▶ [Status Monitor/Cancel] ▶ [Error Information]

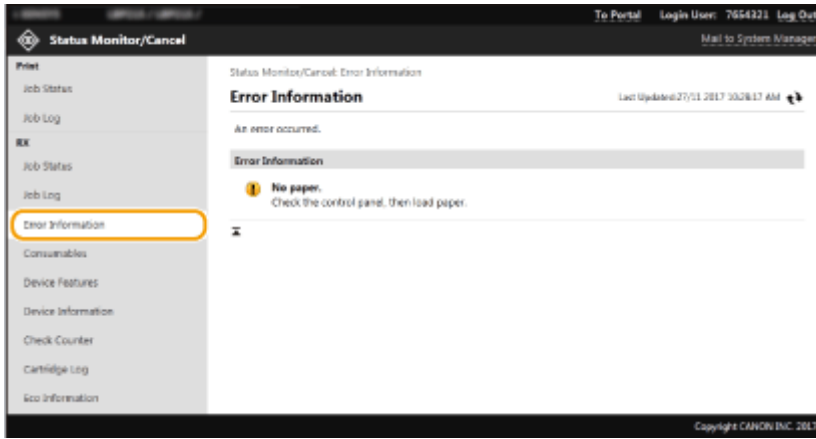

Checking Consumables

Paper size and paper type for the paper source, toner cartridge model number, etc. are displayed. You can also click [Check Consumables Details] in the Portal page (main page) to display this page ([▶ Remote UI Screen\(P. 229\)](#)).



Log in to the Remote UI ([▶ Starting Remote UI\(P. 228\)](#)) ▶ [Status Monitor/Cancel] ▶ [Consumables]

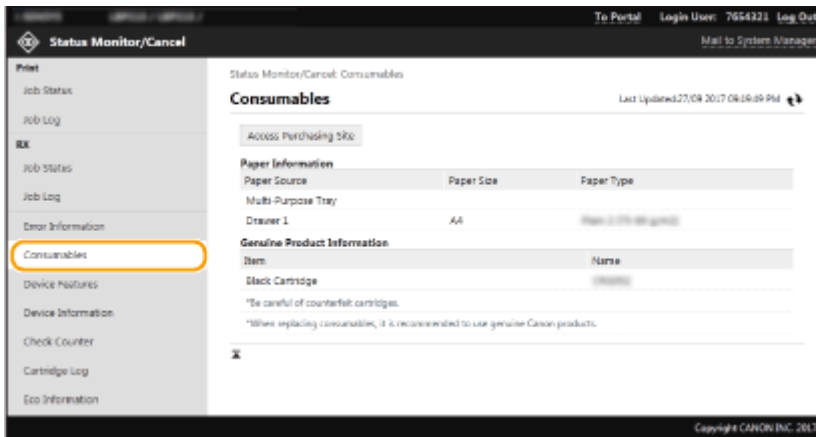

Checking Device Specifications

The maximum print speed and machine features are displayed.



Log in to the Remote UI ([▶ Starting Remote UI\(P. 228\)](#)) ▶ [Status Monitor/Cancel] ▶ [Device Features]

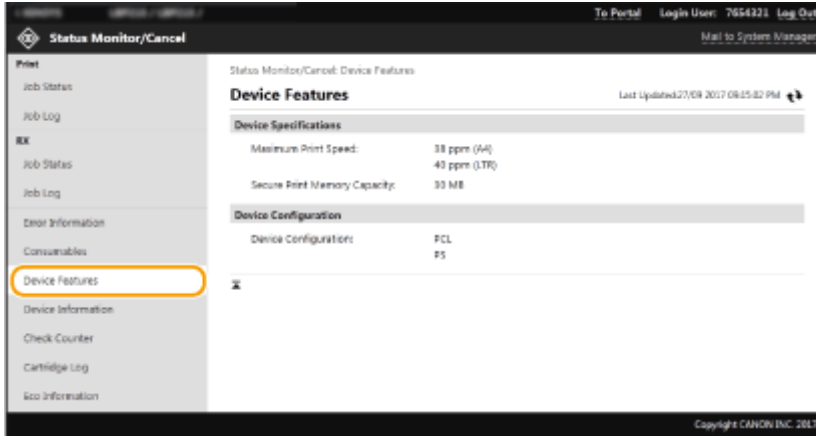

Checking System Manager Information

Information about the machine and the system manager is displayed. The device name and other system manager information displayed here correspond to the settings in [System Manager Information] on the [User Management] page or in [Device Information Settings] on the [Device Management] page.



Log in to the Remote UI (▶ **Starting Remote UI(P. 228)**) ▶ [Status Monitor/Cancel] ▶ [Device Information]

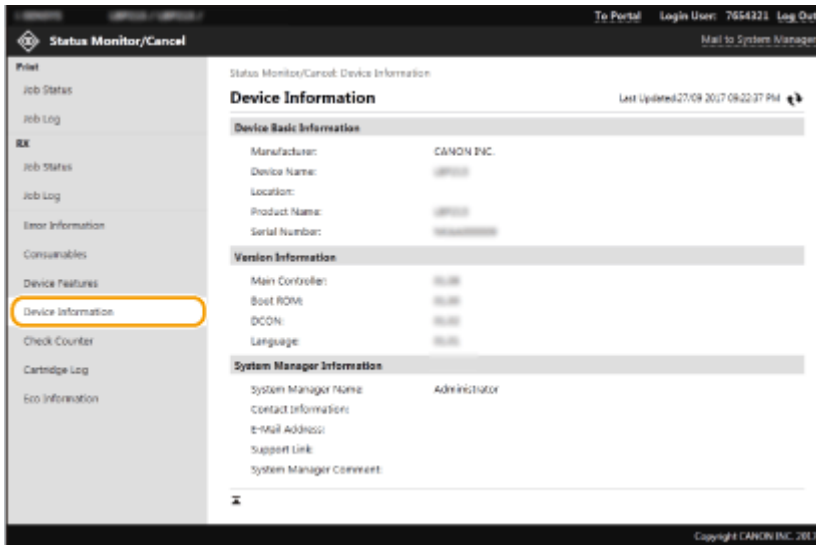

Checking Print Total Counter

The total number of pages that have been printed is displayed.



Log in to the Remote UI (▶ **Starting Remote UI(P. 228)**) ▶ [Status Monitor/Cancel] ▶ [Check Counter]

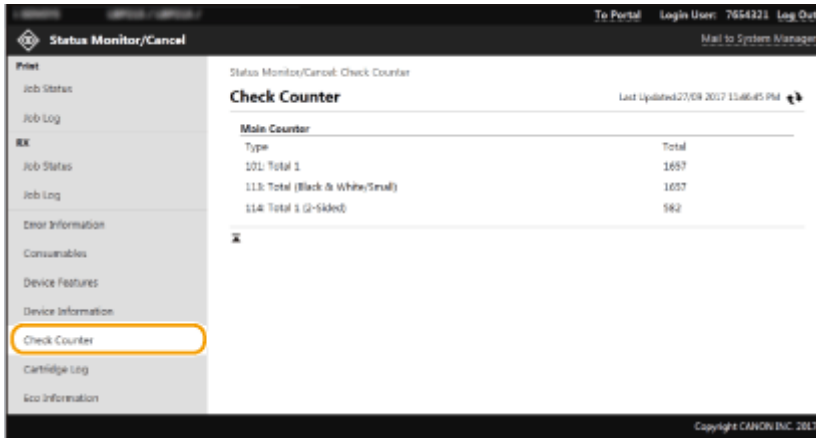

Checking History of Toner Cartridges

You can check the usage logs of toner cartridges and other logs.



Log in to the Remote UI (▶ **Starting Remote UI(P. 228)**) ▶ [Status Monitor/Cancel] ▶ [Cartridge Log]

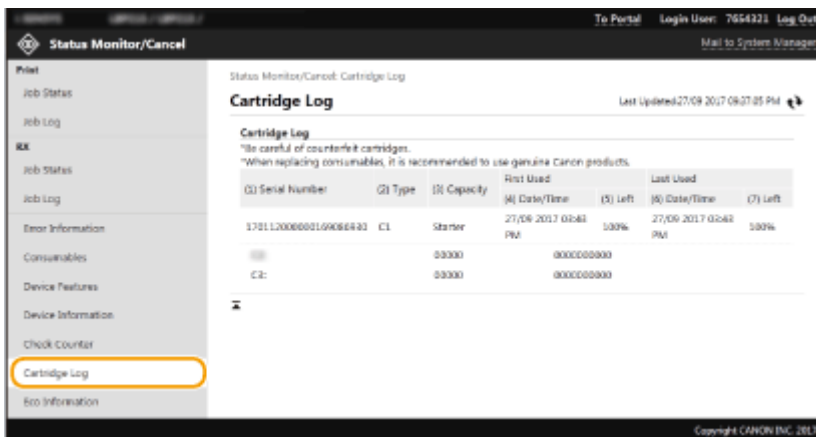

Checking Usage Status of the Machine

The monthly total volume of printouts and monthly total power consumption are displayed. You can display the Eco Information screen and change the settings to save paper and power consumption.



Log in to the Remote UI (▶ **Starting Remote UI(P. 228)**) ▶ [Status Monitor/Cancel] ▶ [Eco Information]

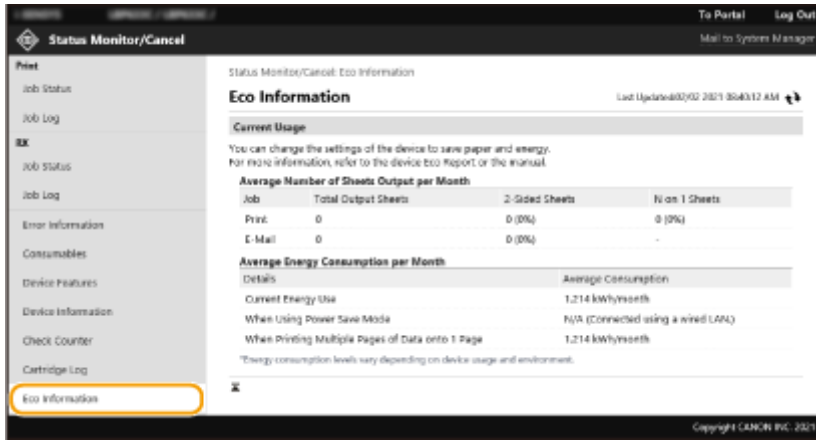

LINKS

▶ Remote UI Screen(P. 229)

Setting Up Menu Options from Remote UI

7YX2-051

You can change the various machine settings by using the Remote UI. Most of the settings can be set also on the machine, but some settings can only be set using the Remote UI. This section describes the basic flow of changing the settings of the machine using the Remote UI.

NOTE

- Some settings can only be changed when you have logged in to System Manager Mode.
- Some settings may require operations that differ from the procedure described here.

- 1 Start the Remote UI. ▶Starting Remote UI(P. 228)**
- 2 Click [Settings/Registration] on the Portal page. ▶Remote UI Screen(P. 229)**
- 3 Click the setting you want to configure in the menu on the left side of the screen.**

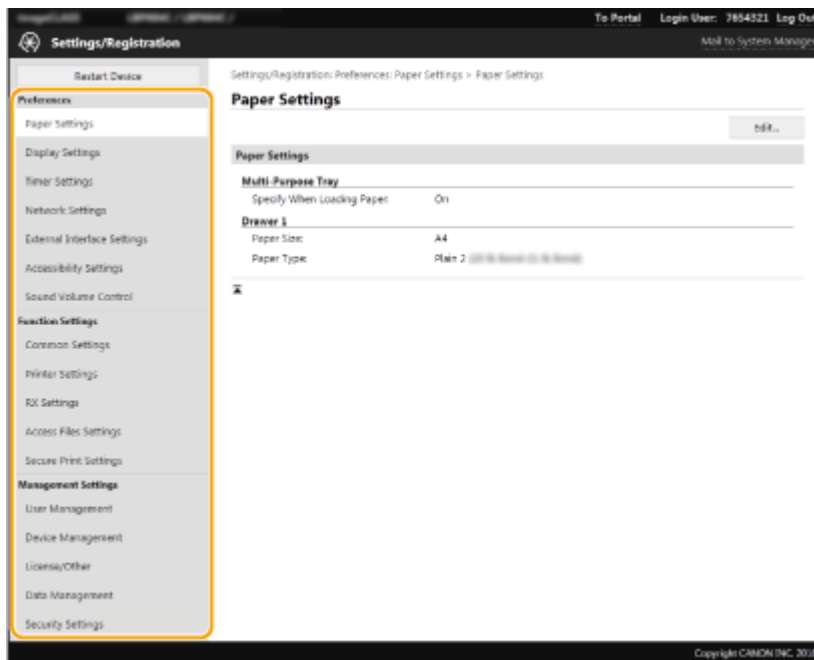

- 4 Click the link to display the desired page as necessary.**

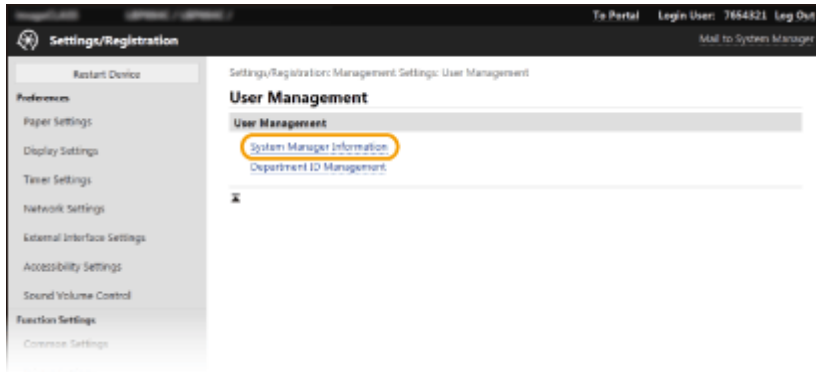

5 Click [Edit].

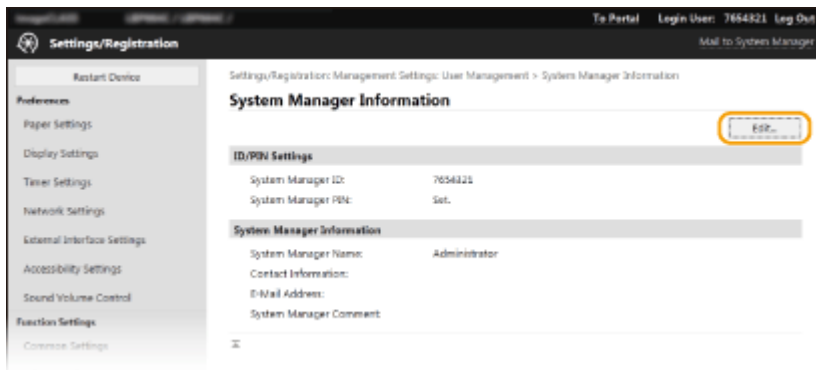

6 Specify the required settings.

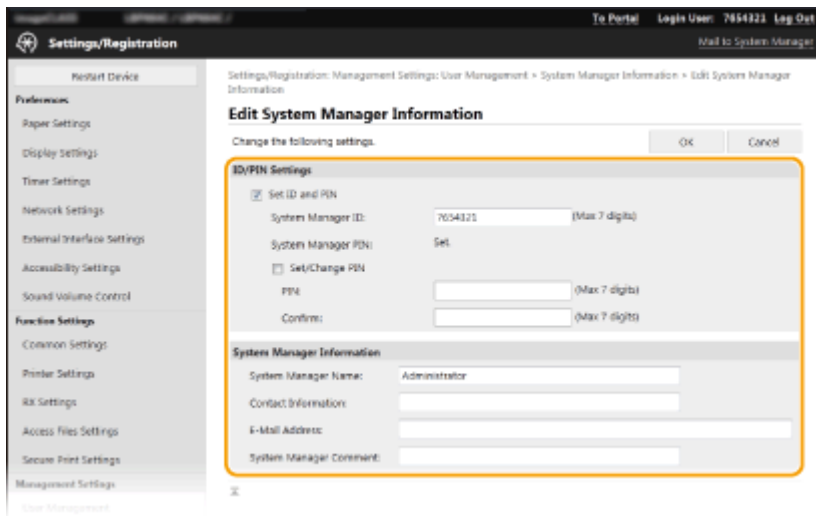

7 Click [OK].

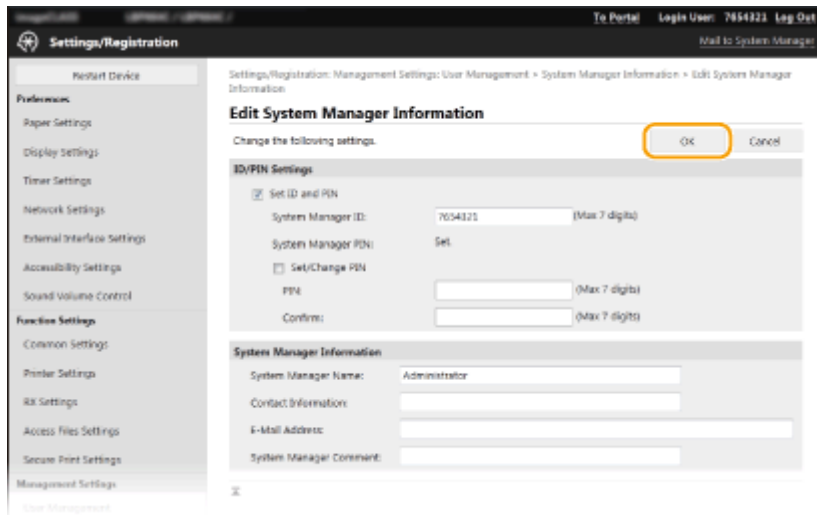

8 Restart the machine as necessary. ▶ Restarting the Machine(P. 87)

NOTE:

- For information about whether you need to restart the machine, view the message on the edit screen.

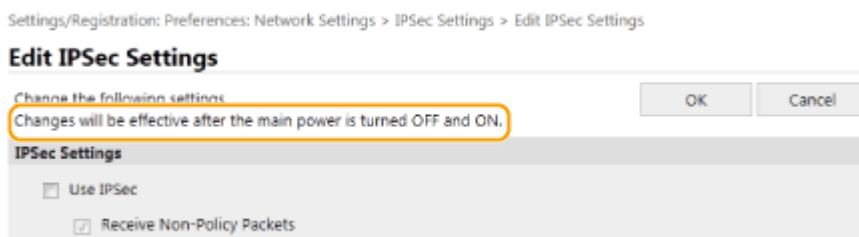

Security Policy

7YX2-052

It is a common practice for organizations to adopt a security policy that defines basic information security objectives and standards, which requires information devices such as computers and printers to be operated accordingly. If you have a security policy to be applied in your organization, apply it to this machine as well.

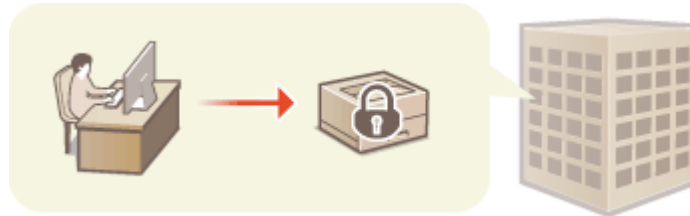

- ▶ **Viewing the Security Policy(P. 240)**
- ▶ **Security Policy Items(P. 240)**
- ▶ **To Apply the Security Policy to the Machine(P. 244)**

Viewing the Security Policy

You can view the security policy set in the machine using the Remote UI.

- 1 Start the Remote UI. ▶Starting Remote UI(P. 228)**
- 2 Click [Settings/Registration] on the Portal page. ▶Remote UI Screen(P. 229)**
- 3 Click [Security Settings] ▶ [Confirm Security Policy].**

Security Policy Items

The following items are displayed by the Remote UI. The items for functions unavailable on this machine are also displayed, but do not affect the machine operation.

■ [Interface]

[Wireless Connection Policy]

Prevent unauthorized access by prohibiting wireless connections.

[Prohibit Use of Direct Connection]	<Use Direct Connection> is set to <Off>. It is not possible to access the machine from mobile devices.	▶<Direct Connection Settings>(P. 269)
[Prohibit Use of Wireless LAN]	<Select Wired/Wireless LAN> is set to <Wired LAN>. It is not possible to establish a wireless connection with the machine via a wireless LAN router or access point.	▶<Select Wired/Wireless LAN>(P. 267)

[USB Policy]

Prevent unauthorized access and data breaches by prohibiting USB connection.

[Prohibit Use as USB Device]	<Use as USB Device> is set to <Off>. It is not possible to connect to a computer via USB.	🔴<Use as USB Device>(P. 281)
[Prohibit Use as USB Storage Device]	<Use USB Storage Device> is set to <Off>. It is not possible to use USB memory devices.	🔴<Use USB Storage Device>(P. 281)

■ [Network]

[Communication Operational Policy]

Increase the security of communications by requiring the verification of signatures and certificates.

[Always Verify Signatures for SMS/ WebDAV Server Functions]	This function is not available on this machine, giving no change to the security level.	—
[Always Verify Server Certificate When Using TLS]	The following settings in [Use TLS for POP] are set to [On]. <ul style="list-style-type: none"> • [Verify Certificate] • [Add CN to Verification Items] 	🔴<Receiving I-Faxes for Printing>(P. 147)
[Prohibit Cleartext Authentication for Server Functions]	<Dedicated Port Authentication Method> is set to <Mode 2>. When using the machine as a server, plain text authentication and functions that use plain text authentication are not available.	🔴<Dedicated Port Authentication Method>(P. 277)
[Prohibit Use of SNMPv1]	In <SNMP Settings>, <SNMPv1 Settings> is set to <Off>. It is not possible to use SNMPv1 when obtaining device information from the computer.	🔴<SNMP Settings>(P. 276)

NOTE

- This setting does not apply to communication with IEEE 802.1X networks, even if [Always Verify Server Certificate When Using TLS] is set to [On].
- If [Prohibit Cleartext Authentication for Server Functions] is set to [On] and your device management software or driver version is old, it may not be possible to connect to the machine. Ensure that you are using the latest versions.

[Port Usage Policy]

Prevent external breaches by closing unused ports.

[Restrict LPD Port (Port Number: 515)]	In <LPD Settings>, <LPD Print Settings> is set to <Off>. It is not possible to perform LPD printing.	🔴<LPD Settings>(P. 274)
[Restrict RAW Port (Port Number: 9100)]	In <RAW Settings>, <RAW Print Settings> is set to <Off>. It is not possible to perform RAW printing.	🔴<RAW Settings>(P. 274)
[Restrict FTP Port (Port Number: 21)]	This function is not available on this machine, giving no change to the security level.	—
[Restrict WSD Port (Port Number: 3702, 60000)]	The following settings in <WSD Settings> are set to <Off>. It is not possible to use WSD functions. <ul style="list-style-type: none"> • <Use WSD Printing> • <Use WSD Browsing> • <Use Multicast Discovery> 	🔴<WSD Settings>(P. 274)
[Restrict BMLinkS Port (Port Number: 1900)]	This function is not available on this machine, giving no change to the security level.	—

Managing the Machine

[Restrict IPP Port (Port Number: 631)]	Part of the settings to enable printing from mobile devices using applications will be turned <Off>, disabling part of printing from mobile devices using applications.	▶ Linking with Mobile Devices(P. 151)
[Restrict SMB Port (Port Number: 137, 138, 139, 445)]	This function is not available on this machine, giving no change to the security level.	—
[Restrict SMTP Port (Port Number: 25)]	This function is not available on this machine, giving no change to the security level.	—
[Restrict Dedicated Port (Port Number: 9002, 9006, 9007, 9011-9015, 9017-9019, 9022, 9023, 9025, 20317, 47545-47547)]	<Dedicated Port Settings> is set to <Off>. It is not possible to use dedicated ports.	▶ <Dedicated Port Settings>(P. 277)
[Restrict Remote Operator's Software Port (Port Number: 5900)]	This function is not available on this machine, giving no change to the security level.	—
[Restrict SIP (IP Fax) Port (Port Number: 5004, 5005, 5060, 5061, 49152)]	This function is not available on this machine, giving no change to the security level.	—
[Restrict mDNS Port (Port Number: 5353)]	The following settings will be turned <Off>, and part of the settings to enable printing from mobile devices using applications will also be turned <Off>. It will be disabled to search the network or perform automatic settings using mDNS. In addition, part of printing from mobile devices using applications will be disabled as well. <ul style="list-style-type: none"> • <mDNS Settings> ▶ <IPv4> ▶ <Use mDNS> • <mDNS Settings> ▶ <IPv6> ▶ <Use mDNS> 	▶ <IPv4 Settings>(P. 270) ▶ <IPv6 Settings>(P. 272) ▶ Linking with Mobile Devices(P. 151)
[Restrict SLP Port (Port Number: 427)]	In [Multicast Discovery Settings], [Discovery Response] is set to [Off]. It is not possible to search the network or perform automatic settings using SLP.	▶ Configuring SLP Communication with Device Management Software(P. 65)
[Restrict SNMP Port (Port Number: 161)]	In <SNMP Settings>, the <SNMPv1 Settings> and <SNMPv3 Settings> are set to <Off>. It is not possible to obtain device information from the computer or configure settings using SNMP.	▶ <SNMP Settings>(P. 276)

■ [Authentication]

[Authentication Operational Policy]

[Prohibit Guest Users to Use Device]	This function is not available on this machine, giving no change to the security level.	—
[Force Setting of Auto Logout]	This function is not available on this machine, giving no change to the security level.	—

[Password Operational Policy]

[Prohibit Caching of Password for External Servers]	This function is not available on this machine, giving no change to the security level.	—
[Display Warning When Default Password Is in Use]	This function is not available on this machine, giving no change to the security level.	—
[Prohibit Use of Default Password for Remote Access]	This function is not available on this machine, giving no change to the security level.	—

[Password Settings Policy]

[Minimum Number of Characters for Password]	This function is not available on this machine, giving no change to the security level.	—
[Password Validity Period]	This function is not available on this machine, giving no change to the security level.	—
[Prohibit Use of 3 or More Identical Consecutive Characters]	This function is not available on this machine, giving no change to the security level.	—
[Force Use of at Least 1 Uppercase Character]	This function is not available on this machine, giving no change to the security level.	—
[Force Use of at Least 1 Lowercase Character]	This function is not available on this machine, giving no change to the security level.	—
[Force Use of at Least 1 Digit]	This function is not available on this machine, giving no change to the security level.	—
[Force Use of at Least 1 Symbol]	This function is not available on this machine, giving no change to the security level.	—



[Lockout Policy]

Block users from logging in for a specified period of time after a certain number of consecutive invalid login attempts.

[Enable Lockout]	In <Lockout Settings>, <Enable Lockout> is set to <On>. Specify the values for <Lockout Threshold> and <Lockout Period>.	 <Lockout Settings>(P. 337)
------------------	--	--

■ [Key/Certificate]

Protect important data by preventing the use of weak encryption, or by saving encrypted user passwords and keys in a designated hardware component.

[Prohibit Use of Weak Encryption]	<Prohibit Use of Weak Encryption> is set to <On>. It is not possible to use weak encryption.	 <Encryption Settings>(P. 337)
[Prohibit Use of Key/Certificate with Weak Encryption]	In <Prohibit Use of Weak Encryption>, <Prohibit Key/Cert. with Weak Encryption> is set to <On>. It is not possible to use a key or certificate with weak encryption.	 <Encryption Settings>(P. 337)
[Use TPM to Store Password and Key]	This function is not available on this machine, giving no change to the security level.	—

■ [Log]

[Force Recording of Audit Log]	This function is not available on this machine, giving no change to the security level.	—
[Force SNTP Settings]	This function is not available on this machine, giving no change to the security level.	—

■ [Job]

[Printing Policy]

[Prohibit Immediate Printing of Received Jobs]	This function is not available on this machine, giving no change to the security level.	—
--	---	---

[Sending/Receiving Policy]

[Allow Sending Only to Registered Addresses]	This function is not available on this machine, giving no change to the security level.	—
[Force Confirmation of Fax Number]	This function is not available on this machine, giving no change to the security level.	—
[Prohibit Auto Forwarding]	This function is not available on this machine, giving no change to the security level.	—

■ [Storage]

[Force Complete Deletion of Data]	This function is not available on this machine, giving no change to the security level.	—
-----------------------------------	---	---

To Apply the Security Policy to the Machine

You can import the security policy edited on the imageRUNNER ADVANCE Series or using Device Management Software to apply it to this machine. In addition, you can export the security policy as applied to this machine to apply it to other machines*. **▶ Importing/Exporting the Setting Data(P. 245)**

*Only Canon devices that are compatible with security policy settings

NOTE

- The security policy settings can only be imported if the security policy setting password on the exporting machine matches that of the importing machine, or if no password has been set for the importing machine. If no password has been set for the importing machine, the password configured for the exporting machine is set to the importing machine.
- You cannot set or change the security policy on this machine.

Importing/Exporting the Setting Data

7YX2-053

Machine settings data can be saved on your computer (export). Data that is saved on your computer can also be registered in the machine (import). Data exported from this machine can be imported to another machine of the same model. So you can easily copy a variety of settings data to multiple machines. To use these features, it is required that you have logged in to System Manager Mode.

▶ **Exporting the Setting Data(P. 245)**

▶ **Importing the Setting Data(P. 246)**

IMPORTANT

Do not turn OFF the machine until the import or export process is complete

- It may take a few minutes to complete the process. If the machine is turned OFF during the process, it may result in damage to data or the machine.

Do not operate the machine during the import or export process

- Before importing/exporting, check that no operation such as printing documents is currently proceeding.

NOTE

- For the settings that cannot be imported/exported, see ▶ **Setting Menu List(P. 254)** .
- You can also import/export settings data via a USB memory device by using the operation panel of the machine. ▶ **<Import/Export>(P. 335)**
- For more information about the basic operations to be performed when setting the machine from the Remote UI, see ▶ **Setting Up Menu Options from Remote UI(P. 237)** .

Exporting the Setting Data

You can export machine settings data, and save them on a computer. It is recommended that you regularly back up important settings.

- 1 Start the Remote UI and log in to System Manager Mode. ▶ Starting Remote UI(P. 228)**
- 2 Click [Settings/Registration] on the Portal page. ▶ Remote UI Screen(P. 229)**
- 3 Select [Data Management] ▶ [Export].**
- 4 Specify the encryption password.**

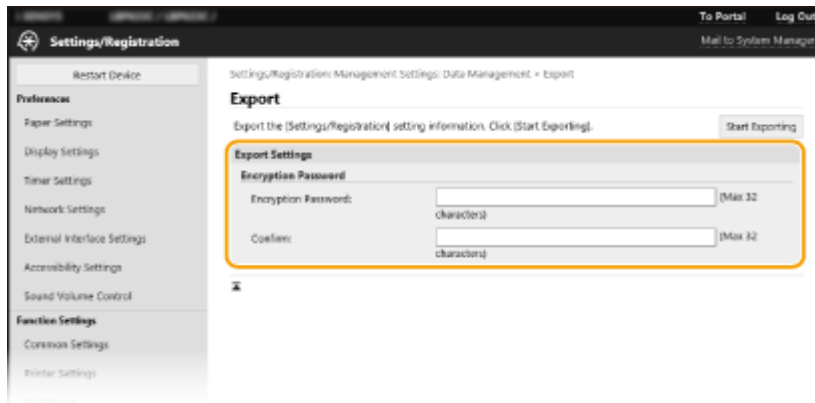

[Encryption Password]

Enter a password to encrypt the export data using alphanumeric characters. Enter the same password in [Confirm]. To export the data, you must set an encryption password.

NOTE:

- The password is required when exported data is imported. ▶ **Importing the Setting Data(P. 246)**

5 Click [Start Exporting].

6 Follow the on-screen instructions to specify the location where to save the exported data.

⇒ The setting data will be saved.

Importing the Setting Data

Load (import) data that was exported from the machine. You can also import machine settings data from another machine to your machine if the models are the same.

1 Start the Remote UI and log in to System Manager Mode. ▶ **Starting Remote UI(P. 228)**

2 Click [Settings/Registration] on the Portal page. ▶ **Remote UI Screen(P. 229)**

3 Select [Data Management] ▶ [Import].

4 Specify the file to import, and enter the password.

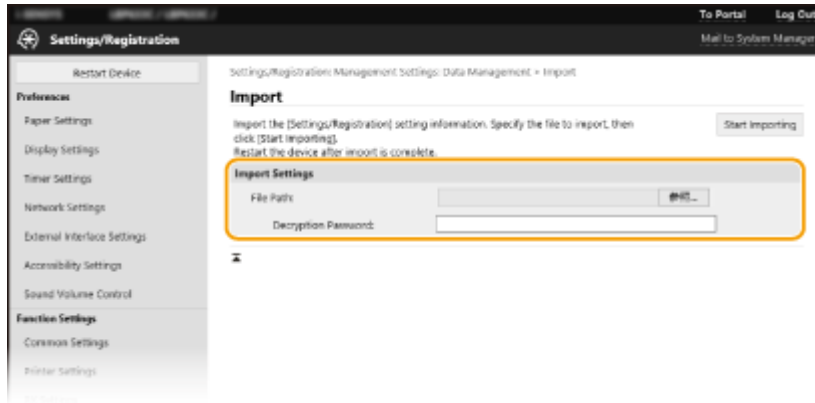

[File Path]

Click [Browse] and select the file. You can only import a device configuration information file (*.dcm).

[Decryption Password]

Enter the password set when the settings were exported.

5 Click [Start Importing].

6 Click [OK].

⇒ The selected settings data is loaded into the machine.

7 Click [OK].

⇒ The machine automatically restarts.

Updating the Firmware

7YX2-054

For the firmware, select the method of update depending on the installation condition of the machine. There are two methods of update: the one is to access the latest firmware version on the Internet from the machine and perform the update if the version currently installed in the machine is not the latest, and the other is to access the latest firmware version on the Internet from a computer and perform the update from the computer if the version currently installed in the machine is not the latest. In an environment where connection to the Internet cannot be established via a wireless LAN, establish connection via a wired LAN or USB and perform the update from the computer.

Installation Condition of the Machine	How to Install the Update
Wireless LAN connection	▶ Updating via the Internet(P. 248)
Wired LAN connection	▶ Updating via the Internet(P. 248) ▶ Updating from a Computer(P. 249)
USB connection	▶ Updating from a Computer(P. 249)

! IMPORTANT

- If you are in an IPv6 environment, you cannot perform firmware update. Use USB to re-establish connection, and perform the update from the computer.

NOTE

Checking the firmware version

- You can check the firmware version from the operation panel of the machine. After completion of the firmware update operation, make sure that the update was performed correctly. ▶ **Checking the Firmware Version(P. 249)**

Updating via the Internet

You can access the Canon server from the machine to update the firmware to the latest version.

- 1 Select <Menu> in the Home screen.** ▶ **Home Screen(P. 91)**
- 2 Select <Management Settings>.**
 - If the login screen appears, enter the correct ID and PIN. ▶ **Logging in to the Machine(P. 100)**
- 3 Select <Remote UI Settings/Update Firmware> ▶ <Update Firmware>.**
- 4 Select <Via Internet>.**

⇒ A check for existence of the latest firmware is performed.

NOTE:

- If the <This is the latest firmware version.> message is displayed, there is no need to update the firmware.

5 Check the message and select <Yes>.

6 When a license screen appears, press .

7 Select <OK>.

⇒ When the firmware update is complete, the machine restarts automatically.

! IMPORTANT:

- Do not turn OFF the machine while the restart is in progress.

Updating from a Computer

When you have downloaded the latest firmware version from the Canon website, use "User Support Tool" utility software to update the firmware from a computer. For how to perform firmware update from a computer, see the "User Support Tool Operation Guide" included with the firmware.

To Put the Machine into a Firmware Update Waiting State



<Menu> ▶ <Management Settings> ▶ <Remote UI Settings/Update Firmware> ▶ <Update Firmware> ▶ <Via PC> ▶ <Yes>

Checking the Firmware Version

1 Select <Menu> in the Home screen.  Home Screen(P. 91)

2 Select <Management Settings>.

- If the login screen appears, enter the correct ID and PIN.  Logging in to the Machine(P. 100)

3 Select <Remote UI Settings/Update Firmware> ▶ <Update Firmware>.

4 Select <Version Information>.

⇒ The current firmware version is displayed.

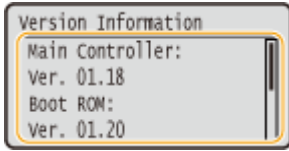

Initializing Settings

7YX2-055



You can restore the following settings:

- ▶ **Initializing Menu(P. 251)**
- ▶ **Initializing Key and Certificate(P. 251)**
- ▶ **Initializing All Data/Settings(P. 252)**

Initializing Menu

You can restore the settings of the machine (▶ **Setting Menu List(P. 254)**). Depending on the settings selected, you may need to restart the machine after initialization.



<Menu> ▶ <Management Settings> ▶ <Data Management> ▶ <Initialize Menu> ▶ Select the item you want to initialize ▶ <Yes> ▶  (Restart the machine if necessary)

NOTE

- You can restore the settings only for <Network> in <Preferences>.
 - <Menu> ▶ <Preferences> ▶ <Network> ▶ <Initialize Network Settings> ▶ <Yes> ▶ Restart the machine

Initializing Key and Certificate

You can restore the settings of the key and certificate and the CA certificate. Note that all the keys and certificates and CA certificates that you registered in the machine (except the preinstalled keys and CA certificates) will be deleted after initializing.

NOTE

- After initializing, functions that require a key and certificate such as TLS encrypted communication and IKE of IPSec communication are not available. To use these functions, configure the settings for the key and certificate and activate the functions again.



<Menu> ▶ <Management Settings> ▶ <Data Management> ▶ <Initialize Key and Certificate> ▶ <Yes> ▶ 

Initializing All Data/Settings

This enables restoration of all data and machine settings, including logs, to the factory default values. This prevents sensitive data from being leaked when replacing or disposing of the machine. When the initialization process finishes, the machine automatically restarts.

IMPORTANT

- Before initializing, make sure that there are no documents being processed or waiting to be processed. These documents will be deleted when initialization is performed.
- To use the machine after initializing it, you need to configure all settings from the beginning.



<Menu> ▶ <Management Settings> ▶ <Initialize All Data/Settings> ▶  ▶ <Yes>

LINKS

 **Configuring the Key and Certificate for TLS(P. 195)**

Setting Menu List

Setting Menu List	254
<Preferences>	255
<Display Settings>	256
<English Keyboard Layout>	261
<Timer/Energy Settings>	262
<Network>	267
<External Interface>	281
<Accessibility>	282
<Volume Settings>	284
<Adjustment/Maintenance>	286
<Adjust Image Quality>	287
<Maintenance>	295
<Function Settings>	296
<Common>	297
<Printer>	300
<Receive>	325
<Secure Print>	327
<Management Settings>	328
<User Management>	329
<Device Management>	330
<Remote UI Settings/Update Firmware>	333
<Data Management>	335
<Security Settings>	337

Setting Menu List

7YX2-056

You can customize the machine based on your environment and needs by configuring settings described in this chapter. To start configuration, select <Menu> on the Home screen (**▶Home Screen(P. 91)**). This section describes what each item in the setting menu can configure.

▶<Preferences>(P. 255)	This section describes the display and network settings.
▶<Adjustment/Maintenance>(P. 286)	This section describes how to adjust print image quality and the cleaning functions of the machine.
▶<Function Settings>(P. 296)	This section describes the settings for the individual functions.
▶<Management Settings>(P. 328)	This section describes the user and hardware information management, security settings, etc.

TIPS

- You can print the setting menu in list form to check the current settings: **▶Printing Lists of Settings(P. 360)**

<Preferences>

7YX2-057

Item	Description
▶<Display Settings>(P. 256)	This section describes the settings related to viewing of the display.
▶<English Keyboard Layout>(P. 261)	This section describes the USB keyboard settings.
▶<Timer/Energy Settings>(P. 262)	This section describes the timer settings and energy settings.
▶<Network>(P. 267)	This section describes the network settings.
▶<External Interface>(P. 281)	This section describes the USB settings and other relevant settings.
▶<Accessibility>(P. 282)	This section describes settings for improving accessibility, such as inverting the screen colors and setting the message display time.
▶<Volume Settings>(P. 284)	This section describes the sound volume settings.

<Display Settings>

7YX2-058

All the settings related to viewing of the display are listed with descriptions. Default settings are marked with a dagger (+).

- ▶<Default Screen After Startup/Restoration>(P. 256)
- ▶<Button Display Order on Home Screen>(P. 256)
- ▶<Language>(P. 256)
- ▶<Remote UI Language>(P. 257)
- ▶<Millimeter/Inch Entry Switch>(P. 258)
- ▶<Displ. Timing for Cartridge Prep. Notif.>(P. 258)
- ▶<Display Notif. to Clean Fixing Assembly> (P. 258)
- ▶<Show Warnings>(P. 259)
- ▶<Action When Warning>(P. 259)
- ▶<Display IP Address>(P. 260)

NOTE

Asterisks (*)

- Settings marked with "*"1" cannot be imported or exported.
- Settings marked with "*"2" may be unavailable or vary or have different defaults depending on your country or region.

<Default Screen After Startup/Restoration>

By default, the Home screen is displayed immediately after the machine is turned ON or when the Auto Reset function is performed. Specify the setting to change the default screen and display the main screen of a different function.

<Home> +
 <Secure Print>
 <Status Monitor>



<Menu> ▶ <Preferences> ▶ <Display Settings> ▶ <Default Screen After Startup/Restoration> ▶ Select a function to display the desired screen ▶

<Button Display Order on Home Screen> *1

Configure the settings for the buttons displayed in the Home screen. ▶<Customizing the Home Screen>(P. 129)

<Language> *2

Select the display language used for the display, reports, and lists.

<Català>

<Čeština>
 <Dansk>
 <Deutsch>
 <Eesti>
 <English> †
 <Español>
 <Euskara>
 <Français>
 <Hrvatski>
 <Italiano>
 <Latviešu>
 <Lietuvių>
 <Magyar>
 <Nederlands>
 <Norsk>
 <Polski>
 <Português>
 <Română>
 <Slovenčina>
 <Slovenščina>
 <Suomi>
 <Svenska>
 <Türkçe>
 <Ελληνικά>
 <Български>
 <Русский>
 <Українська>
 <العربية>
 <日本語>
 <中文(繁體)>
 <中文(简体)>
 <한국어>



<Menu> ▶ <Preferences> ▶ <Display Settings> ▶ <Language> ▶ Select a language ▶ <Yes> ▶

<Remote UI Language> *2

Select the display language used for the Remote UI screens.

<English> †
 <Japanese>
 <French>
 <Spanish>
 <German>
 <Italian>
 <Dutch>
 <Finnish>
 <Portuguese>
 <Norwegian>
 <Swedish>

<Danish>
 <Czech>
 <Hungarian>
 <Russian>
 <Turkish>
 <Polish>
 <Chinese (Simplified)>
 <Chinese (Traditional)>
 <Korean>





<Menu> ▶ <Preferences> ▶ <Display Settings> ▶ <Remote UI Language> ▶ Select a language ▶ 

<Millimeter/Inch Entry Switch>

Select the unit of measurement.

<Millimeter> +
 <Inch>





<Menu> ▶ <Preferences> ▶ <Display Settings> ▶ <Millimeter/Inch Entry Switch> ▶ Select <Millimeter> or <Inch> ▶ 

<Displ. Timing for Cartridge Prep. Notif.>

Set the display timing for the message notifying you that the amount remaining in the toner cartridges is low.

<Auto> +
 <Custom>



<Menu> ▶ <Preferences> ▶ <Display Settings> ▶ <Displ. Timing for Cartridge Prep. Notif.> ▶ <Custom> ▶ Enter toner level ▶  ▶ 

<Display Notif. to Clean Fixing Assembly>

Select whether to display a message that prompts you to clean the fixing unit. If you set to <On>, you can specify the timing to display a prompt message for cleaning the fixing unit, in terms of the number of printed pages and in units of 1,000.

<Off> +

<On>



<Menu> ▶ <Preferences> ▶ <Display Settings> ▶ <Display Notif. to Clean Fixing Assembly> ▶ <On> ▶ Enter the number of printed pages ▶ ▶

<Show Warnings>

Specify whether to display a message telling that the amount remaining in the toner cartridges is low.

<Low Cartridge Level>

<Off>

<On> †



<Menu> ▶ <Preferences> ▶ <Display Settings> ▶ <Show Warnings> ▶ <Low Cartridge Level> ▶ Select <Off> or <On> ▶

NOTE

- When <Action When Warning> is set to <Stop Printing>, you cannot set this item to <Off>.
- When <Continue Print. When Amount in Cart. Low> is set to <Off>, the message will appear even if you set this item to <Off>. ▶<Continue Print. When Amount in Cart. Low>(P. 325)

<Action When Warning>

Specify whether to continue printing when the amount remaining in the toner cartridges is low.

<Low Cartridge Level>

<Continue Printing> †

<Stop Printing>



<Menu> ▶ <Preferences> ▶ <Display Settings> ▶ <Action When Warning> ▶ <Low Cartridge Level> ▶ Select <Continue Printing> or <Stop Printing> ▶ ▶

NOTE

- If you change the setting of this item from <Continue Printing> to <Stop Printing>, <Show Warnings> is set to <On>.

<Display IP Address>

Specify whether to display the machine's IPv4 address on the <Status Monitor> screen.  <Status Monitor> Screen(P. 92)

<Off>
<On> 



<Menu> ▶ <Preferences> ▶ <Display Settings> ▶ <Display IP Address> ▶ Select <Off> or <On> ▶ 

<English Keyboard Layout>

7YX2-059

Specify the layout of a USB keyboard if connected to the machine. The default setting is marked with a dagger (†).

<USA Layout>
<UK Layout> †



<Menu> ▶ <Preferences> ▶ <English Keyboard Layout> ▶ Select <USA Layout> or <UK Layout>
▶ 

<Timer/Energy Settings>

All the settings related to the timer and energy are listed with descriptions. Default settings are marked with a dagger (+).

- ▶<Current Date/Time Settings>(P. 262)
- ▶<Date/Time Settings>(P. 262)
- ▶<Date Format>(P. 263)
- ▶<Time Format>(P. 263)
- ▶<Auto Reset Time>(P. 264)
- ▶<Function After Auto Reset>(P. 264)
- ▶<Auto Shutdown Time>(P. 265)
- ▶<Auto Sleep Time>(P. 265)
- ▶<Auto Sleep Daily Timer>(P. 265)
- ▶<Sleep Mode Exit Time Settings>(P. 266)

NOTE

Asterisks (*)

- Settings marked with "*"1" cannot be imported or exported.
- Settings marked with "*"2" may be unavailable or vary or have different defaults depending on your country or region.

<Current Date/Time Settings> *1

Set the current date and time. ▶<Setting the Date/Time>(P. 9)

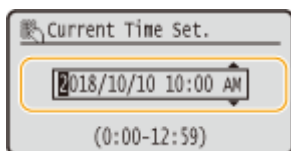

! IMPORTANT

- Set <Time Zone> before setting the current date and time. If the <Time Zone> setting is changed, the current date and time are also changed accordingly.

NOTE

- The current date and time cannot be changed for 1 hour after daylight saving time is in effect.

<Date/Time Settings>

Specify the date and time standard of the region in which the machine is to be installed.

<Time Zone>

Select the time zone. If the time zone setting is changed, the values set in <Current Date/Time Settings> are also changed accordingly.  **Setting the Date/Time(P. 9)**

<(UTC-12:00) International Date Line West> to <(UTC) Coordinated Universal Time>  to <(UTC+14:00) Kiritimati Island>

NOTE

UTC

- Coordinated Universal Time (UTC) is the primary time standard by which the world regulates clocks and time. The correct UTC time zone setting is required for Internet communications.

<Daylight Saving Time Settings> *2

Enable or disable daylight saving time. If daylight saving time is enabled, specify the dates from which and to which daylight saving time is in effect.









<Off>

<On> 

Start: Month, Week, Day

End: Month, Week, Day



<Menu>  <Preferences>  <Timer/Energy Settings>  <Date/Time Settings>  <Daylight Saving Time Settings>  Select <On>, and specify the dates  <Apply>  

<Date Format> *2







Select the date format (order of year, month, and day).

<YYYY MM/DD>

<MM/DD/YYYY>

<DD/MM YYYY> 



<Menu>  <Preferences>  <Timer/Energy Settings>  <Date Format>  Select the date format  

<Time Format>

Select the 12- or 24-hour clock display setting.

<12 Hour (AM/PM)> 

<24 Hour>



<Menu> ▶ <Preferences> ▶ <Timer/Energy Settings> ▶ <Time Format> ▶ Select the display setting ▶

<Auto Reset Time>

If a key is not pressed for a specified period of time, the screen and the settings are initialized to display the default screen (Auto Reset). Specify the interval at which the Auto Reset is performed. The Auto Reset is not performed in the following cases:

- The setting menu is displayed.
- The machine is processing data, such as when printing documents.
- An error message is displayed and the Error indicator is blinking (However, Auto Reset is performed when the error does not prevent the user from continuing to use a function.)

0 (Auto Reset is disabled.)
1 to 2 ⁺ to 9 (min.)



<Menu> ▶ <Preferences> ▶ <Timer/Energy Settings> ▶ <Auto Reset Time> ▶ Specify the Auto Reset time ▶ ▶

NOTE

- The screen displayed after the Auto Reset is performed can be selected in <Function After Auto Reset>.

<Function After Auto Reset>

Select whether to return the display to the default screen after the Auto Reset is performed. If <Default Function> is selected, the main screen of the function selected in <Default Screen After Startup/Restoration> is displayed (**<Default Screen After Startup/Restoration>(P. 256)**). If <Selected Function> is selected, the display returns to the main screen of the function that was selected.

<Default Function> ⁺
<Selected Function>



<Menu> ▶ <Preferences> ▶ <Timer/Energy Settings> ▶ <Function After Auto Reset> ▶ Select <Default Function> or <Selected Function> ▶

<Auto Shutdown Time>

Set a timer to automatically shut down the machine after a specified period of idle time has elapsed since the machine entered the sleep mode.

0 (Auto Shutdown is disabled.)
1 to 4 ⁺ to 8 (hr.)



<Menu> ▶ <Preferences> ▶ <Timer/Energy Settings> ▶ <Auto Shutdown Time> ▶ Set the Auto Shutdown time ▶ <Apply> ▶

! IMPORTANT

Before setting <Auto Shutdown Time>

- When the <Auto Shutdown Time> setting is enabled, the machine may automatically shut down even if you are operating the machine from the Remote UI. A malfunction may occur, particularly if the machine shuts down while data is being imported. When you import data using the Remote UI, set <Auto Shutdown Time> to <Off> or <0> in advance.

NOTE

- If any settings of the [Timer Settings] are changed from the Remote UI while the machine is in the sleep mode, the timer for the <Auto Shutdown Time> setting is reset to the beginning. The machine automatically shuts down after a specified period of idle time has elapsed since the timer was reset.

<Auto Sleep Time>

If the machine has not been operated or has had no data to process for a specified period of time, the machine enters sleep mode to save energy consumption (Auto Sleep). Specify the period of time after which auto sleep is performed. Auto Sleep is not performed when the setting menu is displayed. We recommend using the factory default settings to save the most power. **Entering Sleep Mode(P. 131)**

1 ⁺ to 60 (min.)

<Auto Sleep Daily Timer>

You can specify the time when the machine is automatically set to the sleep mode. **Entering Sleep Mode(P. 131)**

<Off> ⁺

<On>
(0:00 to 23:59)

<Sleep Mode Exit Time Settings>

Specify the time when the machine is recovered from the sleep mode. **▶Entering Sleep Mode(P. 131)**

<Off> ⁺

<On>
(0:00 to 23:59)

<Network>

All the settings related to the network are listed with descriptions. Default settings are marked with a dagger (†).

- ▶<Select Wired/Wireless LAN>(P. 267)
- ▶<Wireless LAN Settings>(P. 267)
- ▶<Direct Connection Settings>(P. 269)
- ▶<Easy Connection via PC>(P. 270)
- ▶<TCP/IP Settings>(P. 270)
- ▶<SNMP Settings>(P. 276)
- ▶<Dedicated Port Settings>(P. 277)
- ▶<Dedicated Port Authentication Method>(P. 277)
- ▶<Waiting Time for Connection at Startup>(P. 277)
- ▶<Ethernet Driver Settings>(P. 278)
- ▶<IEEE 802.1X Settings>(P. 278)
- ▶<Firewall Settings>(P. 278)
- ▶<Device Settings Management On/Off>(P. 280)
- ▶<Monitoring Service>(P. 280)
- ▶<RMT-SW>(P. 280)
- ▶<Initialize Network Settings>(P. 280)

NOTE

Asterisks (*)

- Settings marked with "*1" cannot be imported or exported.
- Settings marked with "*2" may not be displayed depending on the model you are using, options, or other setting items.

<Select Wired/Wireless LAN>

When switching the machine from Wireless LAN to Wired LAN, you need to specify the setting. Conversely, when switching the machine from Wired LAN to Wireless LAN, you do not need to specify this setting (You can switch using the following <Wireless LAN Settings>). ▶<Selecting Wired LAN or Wireless LAN(P. 13)>

<Wired LAN> †

<Wireless LAN>

<Wireless LAN Settings>

Wireless LAN routers that can access the machine are automatically located, so you can select from the list. You must manually enter a network key, such as a WEP key or a PSK. ▶<Setting Up Connection by Selecting a Wireless Router(P. 21)>

<Other Connections>

Select to configure the settings your wireless router is equipped with Wi-Fi Protected Setup (WPS) or you want to manually specify authentication and encryption settings.

<Manually Enter Network Name>

Select to configure a wireless connection by manually entering the network name. By using this method, you can specify authentication and encryption settings in detail. ▶ **Setting Up Connection by Specifying Detailed Settings(P. 23)**

<Security Settings>
 <None>
 <WEP>
 <Open System> †
 WEP Key 1 to 4
 <Shared Key>
 WEP Key 1 to 4
 <WPA/WPA2-PSK>
 <Auto> †
 <AES-CCMP>

<WPS Push Button Mode>

Select to automatically configure a wireless connection by using the button on a WPS wireless router. ▶ **Setting Up Connection Using WPS Push Button Mode(P. 17)**

<WPS PIN Code Mode>

Select to configure a wireless connection by entering a PIN code for a WPS wireless router. ▶ **Setting Up Connection Using WPS PIN Code Mode(P. 19)**

<Connection Settings>

Select to specify the setting for saving power consumption or check the current wireless LAN settings.

<Power Save Mode>

Select whether or not the machine enters Power Save Mode based on signals emitted from the wireless router.

<Off>
 <On> †

<Menu> ▶ <Preferences> ▶ <Network> ▶ <Wireless LAN Settings> ▶ Read the displayed message ▶ <OK> ▶ <Power Save Mode> ▶ Select <Off> or <On> ▶

<Connection Information> *1

Select to view the current wireless LAN settings. ▶ **Viewing Network Settings(P. 34)**

<MAC Address>
 <Wireless LAN Status>
 <Latest Error Information>
 <Channel>
 <Network Name>
 <Security Settings>
 <Power Save Mode>

<Direct Connection Settings>

Set whether to connect directly. By enabling this function, connecting directly with the machine is possible even in an environment without an access point or wireless LAN router. **▶Connecting Directly (Access Point Mode)(P. 154)**

<Use Direct Connection>

<Off> †

<On>

<Time Until Direct Connection Termination>

Specify the time to automatically disconnect after Direct Connection is established.

0 (Do not terminate session automatically) †

1 to 60 (min.)



<Menu> ▶ <Preferences> ▶ <Network> ▶ <Direct Connection Settings> ▶ <Time Until Direct Connection Termination> ▶ Enter the time ▶ ▶

<Access Point Mode Settings>

Configure the SSID/network key arbitrarily. If you want to connect multiple mobile devices to the machine at the same time, you need to configure both SSID and network key arbitrarily.

<Use Custom SSID>

<Off> †

<On>

<SSID>

<Use Custom Network Key>

<Off> †

<On>

<Network Key>



<Menu> ▶ <Preferences> ▶ <Network> ▶ <Direct Connection Settings> ▶ <Access Point Mode Settings> ▶ <Use Custom SSID>/<Use Custom Network Key> ▶ <On> ▶ Enter the SSID/network key ▶ <Apply> ▶

<Keep Enabled If SSID/Ntwk Key Spcfd> *2

Specify whether to keep the machine waiting for Direct Connection.

<Off> †

<On>



<Menu> ▶ <Preferences> ▶ <Network> ▶ <Direct Connection Settings> ▶ <Keep Enabled If SSID/Ntwk Key Spcfd> ▶ Select <Off> or <On> ▶ Restart the machine

NOTE

- When setting this item to <On>, configure in advance a custom SSID or network key using <Access Point Mode Settings>.

<Config. IP Address For Direct Conn.>

Manually enter the machine's IP address at the time of Direct Connection.

192.168.22.1 +



<Menu> ▶ <Preferences> ▶ <Network> ▶ <Direct Connection Settings> ▶ <Config. IP Address For Direct Conn.> ▶ Enter an arbitrary IP address ▶ ▶

<Easy Connection via PC>

Start the procedure for Easy Connection via PC (cableless setup mode). You can use Canon Laser NW Device Setup Utility to configure network settings via a computer.



<Menu> ▶ <Preferences> ▶ <Network> ▶ <Easy Connection via PC> ▶ <Yes> ▶ The connection process starts

NOTE

- Download Canon Laser NW Device Setup Utility from the Canon website (<https://global.canon/>).

<TCP/IP Settings>

Specify settings for using the machine in a TCP/IP network, such as IP address settings.

<IPv4 Settings>

Specify settings for using the machine in an IPv4 network.

<IP Address Settings>

Configure the IP address, which is used for identifying devices, such as computers and printers, on a TCP/IP network. **Setting IPv4 Address(P. 28)**

<Auto Acquire>

```

<Select Protocol>
  <Off>
  <DHCP> +
<Auto IP>
  <Off>
  <On> +

<Manually Acquire> *2
  <IP Address>: 0.0.0.0
  <Subnet Mask>: 0.0.0.0
  <Gateway Address>: 0.0.0.0

<Check Settings>
  <Auto Acquire>*2
  <Select Protocol>*2
  <Auto IP>*2
  <IP Address>
  <Subnet Mask>
  <Gateway Address>

```

<PING Command>

Select to check that the machine is connected to a computer over a network. ▶ **Testing the Network Connection(P. 29)**

<DNS Settings>

Specify settings for Domain Name System (DNS), which provides a host name for IP address resolutions. ▶ **Configuring DNS(P. 51)**

```

<DNS Server Settings>
  <Primary DNS Server>: 0.0.0.0
  <Secondary DNS Server>: 0.0.0.0

<DNS Host Name/Domain Name Settings>
  <Host Name>
  <Domain Name>

<DNS Dynamic Update Settings>
  <Off> +
  <On>
  <DNS Dyn. Updt. Intrvl.>
    0 to 24 + to 48 (hr.)

```

<mDNS Settings>

Specify settings for using DNS functions without DNS servers. ▶ **Configuring DNS(P. 51)**

```

<Off>

<On> +
  <mDNS Name>

```

<DHCP Option Settings>

If DHCP is enabled, use these settings to select whether to use the DHCP optional functions to acquire the DNS server address or the domain name. ▶ **Configuring DNS(P. 51)**

```

<Acquire Host Name>

```

<Off> <On> †
<DNS Dynamic Update> <Off> † <On>
<Acquire DNS Server Address> <Off> <On> †
<Acquire Domain Name> <Off> <On> †
<Acquire WINS Server Address> <Off> <On> †
<Acquire POP Server Address> <Off> † <On>

<IPv6 Settings>

Specify settings for using the machine in an IPv6 network.

<Use IPv6>

Enable or disable IPv6 in the machine. You can also view the current settings. ▶ **Setting IPv6 Addresses(P. 31)**

<Off> † <On>
<Check Settings> <Link-Local Address> <Prefix Length>

<Stateless Address Settings>

Enable or disable stateless addresses. ▶ **Setting IPv6 Addresses(P. 31)**

<Off> <On> †
<Check Settings> <Stateless Address> <Prefix Length>

<Use DHCPv6>

Enable or disable the stateful address that is acquired via DHCPv6. ▶ **Setting IPv6 Addresses(P. 31)**

<Off> †

<On>

<Check Settings>

<Stateful Address>

<Prefix Length>

<DNS Settings>

Specify settings for Domain Name System (DNS), which provides a host name for IP address resolutions.  **Configuring DNS(P. 51)**

<DNS Host Name/Domain Name Settings>

<Use IPv4 Host/Domain>

<Off>

<Host Name>

<Domain Name>

<On> †

<DNS Dynamic Update Settings>

<Off> †

<On>

<Regist. Manual Addr.>

<Off> †

<On>

<Regist. Stateful Addr.>

<Off> †

<On>

<Regist Stateless Addr.>

<Off> †

<On>

<DNS Dynamic Update Interval>

0 to 24 † to 48 (hr.)

<mDNS Settings>

Specify settings for using DNS functions without DNS servers.  **Configuring DNS(P. 51)**

<Off>

<On> †

<Use IPv4 Name for mDNS>

<Off>

<mDNS Name>

<On> †

<DHCP Option Settings>

If DHCP is enabled, use these settings to select whether to use the DHCP optional functions to acquire the DNS server address or the domain name.  **Configuring DNS(P. 51)**

<Acquire DNS Server Address>

<Off>

<On> †

<Acquire Domain Name>

<Off>
<On> †

<WINS Settings>

Specify settings for Windows Internet Name Service (WINS), which provides a computer name for IP address resolutions in a mixed network environment of NetBIOS and TCP/IP. ▶ **Configuring WINS(P. 57)**

<WINS Resolution>

<Off> †
<On>
<WINS Server Address>: 0.0.0.0

<LPD Settings>

Enable or disable LPD, a printing protocol that can be used on any hardware platform or operating system. You can also set the reception timeout period after which printing is canceled if print data reception is interrupted.

▶ **Configuring Printing Protocols and WSD Functions(P. 37)**

<LPD Print Settings>

<Off>
<On> †

<RX Timeout>

1 to 5 † to 60 (min.)

<RAW Settings>

Enable or disable RAW, a Windows specific printing protocol. You can also set the reception timeout period after which printing is canceled if print data reception is interrupted. ▶ **Configuring Printing Protocols and WSD Functions(P. 37)**

<RAW Print Settings>

<Off>
<On> †

<RX Timeout>

1 to 5 † to 60 (min.)

<WSD Settings>

Enable or disable automatic browsing and acquiring information for the printer by using the WSD protocol. ▶ **Configuring Printing Protocols and WSD Functions(P. 37)**

<WSD Print Settings>

<Use WSD Print>
<Off>
<On> †

<Use WSD Browsing>

<Off>
<On> †

<Use Multicast Discovery>

<Off>
<On> †

<Use HTTP>

Enable or disable HTTP, which is required for communications with a computer, such as when using the Remote UI or WSD printing. **▶ Disabling HTTP Communication(P. 224)**

<Off>
<On> †

<Use IPSec> *1

Select whether to perform encrypted communication by establishing a virtual private network (VPN) via IPSec. **▶ Configuring IPSec Settings(P. 209)**

<Off> †
<On>



<Menu> ▶ <Preferences> ▶ <Network> ▶ <TCP/IP Settings> ▶ <Use IPSec> ▶ Select <Off> or <On> ▶ Restart the machine

<Port Number Settings>

Change port numbers for protocols according to the network environment. **▶ Changing Port Numbers(P. 192)**

<LPD>

1 to 515 † to 65535

<RAW>

1 to 9100 † to 65535

<WSD Multicast Discovery>

1 to 3702 † to 65535

<HTTP>

1 to 80 † to 65535

<Multicast Discovery>

1 to 427 † to 65535

<POP3>

1 to 110 † to 65535

<SNMP>

1 to 161 † to 65535

<MTU Size>

Select the maximum size of packets the machine sends or receives. **▶ Changing the Maximum Transmission Unit(P. 49)**

<1300>
<1400>
<1500> †

<SNMP Settings>

Specify the settings for monitoring and controlling the machine from a computer running SNMP-compatible software.

Monitoring and Controlling the Machine with SNMP(P. 59)

<SNMPv1 Settings>

Enable or disable SNMPv1. When enabling SNMPv1, specify a community name and access privileges to Management Information Base (MIB) objects.

<Off>
<On> +



<Menu> ▶ <Preferences> ▶ <Network> ▶ <SNMP Settings> ▶ <SNMPv1 Settings> ▶ Select <Off> or <On> ▶ Restart the machine

<SNMPv3 Settings>

Enable or disable SNMPv3. Use the Remote UI to specify detailed settings that are applied when SNMPv3 is enabled.

<Off> +
<On>



<Menu> ▶ <Preferences> ▶ <Network> ▶ <SNMP Settings> ▶ <SNMPv3 Settings> ▶ Select <Off> or <On> ▶ Restart the machine

<Acquire Printer Mngt. Info. from Host>

Enable or disable the monitoring of printer management information from a networked computer running SNMP-compatible software.

<Off> +
<On>



<Menu> ▶ <Preferences> ▶ <Network> ▶ <SNMP Settings> ▶ <Acquire Printer Mngt. Info. from Host> ▶ Select <Off> or <On> ▶ Restart the machine

<Format Host Rsrcs. MIB to RFC2790>

Specify whether to conform to the advanced specifications (RFC2790) of the protocol when monitoring the machine status from the SNMP-compatible software.

<Off>
<On> +



<Menu> ▶ <Preferences> ▶ <Network> ▶ <SNMP Settings> ▶ <Format Host Resources MIB to RFC2790> ▶ Select <Off> or <On> ▶ Restart the machine

<Dedicated Port Settings>

Enable or disable the dedicated port. The dedicated port is used when printing from the computer and when browsing or specifying the machine settings over the network.

<Off>
<On> [†]



<Menu> ▶ <Preferences> ▶ <Network> ▶ <Dedicated Port Settings> ▶ Select <Off> or <On> ▶ Restart the machine

<Dedicated Port Authentication Method>

Specify whether to limit the authentication method specifically to the secure one when using the dedicated port. If <Mode 2> is selected, the authentication method is limited specifically to the secure one.

<Mode 1> [†]
<Mode 2>



<Menu> ▶ <Preferences> ▶ <Network> ▶ <Dedicated Port Authentication Method> ▶ Select <Mode 1> or <Mode 2> ▶

IMPORTANT

- If <Mode 2> is selected, you cannot establish a connection from the device management software or driver in some cases.

<Waiting Time for Connection at Startup>

Specify a wait time for connecting to a network. Select the setting depending on the network environment. **Setting a Wait Time for Connecting to a Network(P. 50)**

0 [†] to 300 (sec.)

<Ethernet Driver Settings>

Select the Ethernet type (10BASE-T/100BASE-TX/1000BASE-T) and the communication mode of Ethernet (half-duplex/full-duplex). You can also view the MAC address for wired LAN.

<Auto Detect>

Select whether to automatically detect or manually select the communication mode and the Ethernet type. ▶ **Configuring Ethernet Settings(P. 47)**

<Off>
 <Communication Mode>
 <Half Duplex> †
 <Full Duplex>
 <Ethernet Type>
 <10BASE-T> †
 <100BASE-TX>
 <1000BASE-T>
 <On> †

NOTE

- When <Communication Mode> is set to <Half Duplex>, you cannot select <1000BASE-T>.

<MAC Address>

Check the MAC address of the machine, which is a number unique to each communication device. ▶ **Viewing the MAC Address for Wired LAN(P. 34)**

<IEEE 802.1X Settings> *1*2

Enable or disable IEEE 802.1X authentication. ▶ **Configuring IEEE 802.1X Authentication Settings(P. 216)**

<Off> †
 <On>



<Menu> ▶ <Preferences> ▶ <Network> ▶ <IEEE 802.1X Settings> ▶ Select <Off> or <On> ▶ Restart the machine

<Firewall Settings>

Without proper security, unauthorized third parties can access computers and other communication devices that are connected to a network. To prevent this unauthorized access, specify the settings for packet filter, a feature that restricts communication to devices with specified IP addresses or MAC addresses.

<IPv4 Address Filter>

Enable or disable settings for filtering packets sent to or received from devices with specified IPv4 addresses. ▶
Specifying IP Addresses for Firewall Settings(P. 186)

<Outbound Filter>

<Off> †

<On>

<Inbound Filter>

<Off> †

<On>



<Menu> ▶ <Preferences> ▶ <Network> ▶ <Firewall Settings> ▶ <IPv4 Address Filter> ▶ Select
 <Outbound Filter> or <Inbound Filter> ▶ Select <Off> or <On> ▶ Restart the machine

<IPv6 Address Filter>

Enable or disable settings for filtering packets sent to or received from devices with specified IPv6 addresses. ▶
Specifying IP Addresses for Firewall Settings(P. 186)

<Outbound Filter>

<Off> †

<On>

<Inbound Filter>

<Off> †

<On>



<Menu> ▶ <Preferences> ▶ <Network> ▶ <Firewall Settings> ▶ <IPv6 Address Filter> ▶ Select
 <Outbound Filter> or <Inbound Filter> ▶ Select <Off> or <On> ▶ Restart the machine

<MAC Address Filter>

Enable or disable settings for filtering packets sent to or received from devices with specified MAC addresses. ▶
Specifying MAC Addresses for Firewall Settings(P. 189)

<Outbound Filter>

<Off> †

<On>

<Inbound Filter>

<Off> †

<On>



<Menu> ▶ <Preferences> ▶ <Network> ▶ <Firewall Settings> ▶ <MAC Address Filter> ▶ Select <Outbound Filter> or <Inbound Filter> ▶ Select <Off> or <On> ▶ Restart the machine

<Device Settings Management On/Off>

Specify whether to use iW Management Console plug-ins to manage machine data such as settings. For detailed information on iW Management Console, contact your dealer or service representative. ▶ **Configuring Settings for Communication between the Machine and Plug-ins(P. 66)**

<Off>
<On> +

<Monitoring Service> *1

Enable communication with a remote monitoring server. Execution of this item enables information about the machine to be periodically sent to the remote monitoring server connected to the machine.



<Menu> ▶ <Preferences> ▶ <Network> ▶ <Monitoring Service> ▶ <Yes> ▶

<RMT-SW>

Leave this switch set to <Off>. When the service representative remotely performs device maintenance, you may be asked to set the switch to <On>.

<Off> +
<On>



<Menu> ▶ <Preferences> ▶ <Network> ▶ <RMT-SW> ▶ Select <Off> or <On> ▶ Restart the machine

<Initialize Network Settings>

Select to return the Network Settings to the factory defaults. ▶ **<Initialize Menu>(P. 336)**

<External Interface>

All the settings related to the USB are listed with descriptions. Default settings are marked with a dagger (†).

<USB Settings>

Specify whether to enable or disable use of the USB port or a USB memory device.

<Use as USB Device>

Enable or disable the USB port that is used for connecting the machine to a computer.  **Restricting the USB Connection with a Computer(P. 223)**

<Off>
<On> †

<Use USB Storage Device>

Specify whether to use a USB memory device.

<Off>
<On> †



<Menu> ▶ <Preferences> ▶ <External Interface> ▶ <USB Settings> ▶ <Use USB Storage Device> ▶ Select <Off> or <On> ▶ Restart the machine

<Accessibility>

All the settings related to accessibility, such as inverting the screen colors and message display time, are listed with descriptions. Default settings are marked with a dagger (†).

- ▶<Invert Screen Colors>(P. 282)
- ▶<Brightness>(P. 282)
- ▶<Contrast>(P. 282)
- ▶<Message Display Time>(P. 283)
- ▶<Scrolling Speed>(P. 283)
- ▶<Cursor Movement Type>(P. 283)

<Invert Screen Colors>

Select <On> to invert the display colors. Select <On> if the display is hard to view even after the brightness was adjusted in <Brightness>.

<Off> †
<On>



<Menu> ▶ <Preferences> ▶ <Accessibility> ▶ <Invert Screen Colors> ▶ Select <Off> or <On> ▶

<Brightness>

Adjust the brightness of the display to suit the installation location of the machine.

Five Levels



<Menu> ▶ <Preferences> ▶ <Accessibility> ▶ <Brightness> ▶ Adjust the brightness ▶ ▶

<Contrast>

Adjust the contrast (the difference between the light and dark parts) of the display to suit the installation location of the machine.

Seven Levels



<Menu> ▶ <Preferences> ▶ <Accessibility> ▶ <Contrast> ▶ Adjust the contrast ▶ ▶

<Message Display Time>

Specify the interval in seconds at which two different messages are alternately displayed.

1 to 2 † to 5 (sec.)



<Menu> ▶ <Preferences> ▶ <Accessibility> ▶ <Message Display Time> ▶ Enter a number for the interval ▶ ▶

<Scrolling Speed>

Adjust the scrolling speed of the screen by selecting from three levels.

<Slow>
<Standard> †
<Fast>



<Menu> ▶ <Preferences> ▶ <Accessibility> ▶ <Scrolling Speed> ▶ Select the speed ▶

<Cursor Movement Type>

Configure how the cursor moves after a character is entered on the screen. If <Auto> is selected, the cursor automatically moves to the next entry field after text has been entered. If <Manual> is selected, use to move the cursor.

<Auto> †
<Manual>



<Menu> ▶ <Preferences> ▶ <Accessibility> ▶ <Cursor Movement Type> ▶ Select <Auto> or <Manual> ▶

<Volume Settings>

All the settings used to generate the confirmation sound of a key being pressed, the sound indicating completion of the printing process, and other sounds, are listed with descriptions. Default settings are marked with a dagger (†).

- ▶<Entry Tone>(P. 284)
- ▶<Invalid Entry Tone>(P. 284)
- ▶<Restock Supplies Tone>(P. 284)
- ▶<Warning Tone>(P. 284)
- ▶<Job Done Tone>(P. 285)
- ▶<Energy Saver Alert>(P. 285)

NOTE

- For information about the setting procedures, see ▶<Setting Sounds>(P. 130) .

<Entry Tone>

Select whether an entry tone is generated when a key on the operation panel has been pressed.

<Off>
<On> †

<Invalid Entry Tone>

Select whether a tone is generated when an invalid key operation has been performed, for example, when an invalid numeric value has been entered.

<Off> †
<On>

<Restock Supplies Tone>

Select whether a tone is generated that indicates the end of toner cartridge lifetime is approaching.

<Off> †
<On>

<Warning Tone>

Select whether to generate a tone telling that a trouble has occurred on the machine, such as a paper jam, incorrect operation, or press of an inoperable key.

<Off>
<On> †

<Job Done Tone>

Select whether a tone is generated when printing has been completed.

<Off>
<On> +

<Energy Saver Alert>

Select whether to generate the notification tone when the machine enters or exits sleep mode.

<Off> +
<On>

<Adjustment/Maintenance>

7YX2-05J

Item	Description
▶<Adjust Image Quality>(P. 287)	This section describes how to adjust image quality for printing.
▶<Maintenance>(P. 295)	This section describes how to use the cleaning functions.

<Adjust Image Quality>

All the settings related to image quality adjustment are listed with descriptions. Default settings are marked with a dagger (†).

- ▶<Printer Density>(P. 287)
- ▶<Toner Save>(P. 287)
- ▶<Adjust Print Position>(P. 287)
- ▶<Special Processing>(P. 288)

NOTE

Asterisks (*)

- Settings marked with an asterisk (*) may not be displayed depending on the model you are using, options, or other setting items.

<Printer Density>

Adjust this if the printed text or thin lines are faded. ▶<Adjusting Print Density>(P. 356)

Nine Levels

<Toner Save>

You can save toner when performing report printing.

<Off> †
<On>



<Menu> ▶ <Adjustment/Maintenance> ▶ <Adjust Image Quality> ▶ <Toner Save> ▶ Select <Off> or <On> ▶

<Adjust Print Position>

Adjust the print position for each paper source. The print position can be adjusted in the range from -5.0 mm to +5.0 mm in increments of 0.1 mm. ▶<Adjusting Print Position>(P. 357)

<Multi-Purpose Tray>
<Adjust Vertically (Front Side)>
-5.0 to 0.0 † to + 5.0 (mm)
<Adjust Horizontally (Front Side)>
-5.0 to 0.0 † to + 5.0 (mm)
<Adjust Vertically (Back Side)>

-5.0 to 0.0 **†** to + 5.0 (mm)
 <Adjust Horizontally (Back Side)>
 -5.0 to 0.0 **†** to + 5.0 (mm)

<Drawer 1>

<Adjust Vertically (Front Side)>
 -5.0 to 0.0 **†** to + 5.0 (mm)
 <Adjust Horizontally (Front Side)>
 -5.0 to 0.0 **†** to + 5.0 (mm)
 <Adjust Vertically (Back Side)>
 -5.0 to 0.0 **†** to + 5.0 (mm)
 <Adjust Horizontally (Back Side)>
 -5.0 to 0.0 **†** to + 5.0 (mm)

<Drawer 2> *

<Adjust Vertically (Front Side)>
 -5.0 to 0.0 **†** to + 5.0 (mm)
 <Adjust Horizontally (Front Side)>
 -5.0 to 0.0 **†** to + 5.0 (mm)
 <Adjust Vertically (Back Side)>
 -5.0 to 0.0 **†** to + 5.0 (mm)
 <Adjust Horizontally (Back Side)>
 -5.0 to 0.0 **†** to + 5.0 (mm)

<Special Processing>

If the print results on special types of paper are not satisfactory, the following settings may improve the quality of the printouts.

<Special Paper Processing>

When printing on the back side of printed paper, rough paper, or envelopes, the print results may be improved by adjusting the following settings.

<Manual Back Side Print (2-Sided Only)>

If printouts on the back side of printed paper are too light, select <On>. You can specify this setting separately for each paper source.

<Multi-Purpose Tray>

<Off> **†**
 <On>



<Drawer 1>

<Off> **†**
 <On>

<Drawer 2> *

<Off> **†**
 <On>



<Menu> ▶ <Adjustment/Maintenance> ▶ <Adjust Image Quality> ▶ <Special Processing> ▶ <Special Paper Processing> ▶ <Manual Back Side Print (2-Sided Only)> ▶ Select the paper source ▶ <On> ▶  ▶ 

NOTE:



- If you set to <On>, image quality may be affected when a certain length of time elapses after printing on the front side or depending on the ambient humidity.

<Rough Surface Envelope Mode>

When printing on envelopes with rough surfaces, select <On>. However, the printing speed may be slower.

<Off> †
<On>



<Menu> ▶ <Adjustment/Maintenance> ▶ <Adjust Image Quality> ▶ <Special Processing> ▶ <Special Paper Processing> ▶ <Rough Surface Envelope Mode> ▶ <On> ▶  ▶ 

NOTE:



- <Rough Surface Envelope Mode> functions only when the paper type setting is <Envelope 2>.  **Specifying Paper Size and Type(P. 117)**
- If you set to <On>, the <Paper Curl Correction> setting will be disabled.

<Paper Wrinkle Correction>

Printouts may wrinkle depending on the paper to use. In this case, setting this item to <On> may solve the problem.

<Off> †
<On>



<Menu> ▶ <Adjustment/Maintenance> ▶ <Adjust Image Quality> ▶ <Special Processing> ▶ <Special Paper Processing> ▶ <Paper Wrinkle Correction> ▶ <On> ▶  ▶ 

NOTE:



- If you set to <On>, the print may be faded or the printing speed may be slower.

<Paper Curl Correction>

If the printed paper curls, set this item to <On>.

<Off> †
<On>



<Menu> ▶ <Adjustment/Maintenance> ▶ <Adjust Image Quality> ▶ <Special Processing> ▶ <Special Paper Processing> ▶ <Paper Curl Correction> ▶ <On> ▶  ▶ 

NOTE:



- If you set to <On>, the printing speed may be slower.

<Rdc. Tnr Flaking from Heavy Sml. Ppr>

When a halftone image such as a photograph is printed on a small size piece of heavy paper, streaks may appear on the back side of the paper. In this case, setting this item to <On> may solve the problem.

<Off> 
 <On>



<Menu> ▶ <Adjustment/Maintenance> ▶ <Adjust Image Quality> ▶ <Special Processing> ▶ <Special Paper Processing> ▶ <Rdc. Tnr Flaking from Heavy Sml. Ppr> ▶ <On> ▶  ▶ 

NOTE:



- If you set to <On>, the printing speed may be slower.

<Reduce Thin Paper Curling>

If printing on thin paper produces curled printouts, setting this item to <On> may solve the problem.

<Off> 
 <On>



<Menu> ▶ <Adjustment/Maintenance> ▶ <Adjust Image Quality> ▶ <Special Processing> ▶ <Special Paper Processing> ▶ <Reduce Thin Paper Curling> ▶ <On> ▶  ▶ 

NOTE:

- <Reduce Thin Paper Curling> functions only when the paper type setting is <Thin 1>.  **Specifying Paper Size and Type(P. 117)**
- If you set to <On>, automatic 2-sided printing with <Thin 1> is disabled. Further, printouts may be faded due to poor fixing of toner.

<Reduce Ppr. Sticking at Output>

In 2-sided printing, printed paper may stick to each other depending on the image density of print data. In this case, setting this item to <On> may solve the problem.

<Off> 
 <On>



<Menu> ▶ <Adjustment/Maintenance> ▶ <Adjust Image Quality> ▶ <Special Processing>
▶ <Reduce Ppr. Sticking at Output> ▶ <On> ▶  ▶ 

NOTE

- If you set to <On>, the printing speed may be slower.

<High Humidity Mode>

Print density may be uneven when the machine is used in an environment with high humidity. In this case, setting this item to <On> may solve the problem.

<Off> +
<On>



<Menu> ▶ <Adjustment/Maintenance> ▶ <Adjust Image Quality> ▶ <Special Processing> ▶ <High Humidity Mode> ▶ <On> ▶  ▶ 

NOTE

- If you set to <On>, the print density may vary depending on the ambient humidity.

<Low Humidity Mode>

When using the machine in an environment with low humidity, printed images and text may be blurry. In this case, set this item. The improvement effect is stronger with <Mode 2> than with <Mode 1>. First try the adjustment with <Mode 1>.

<Off> +
<Mode 1>
<Mode 2>



<Menu> ▶ <Adjustment/Maintenance> ▶ <Adjust Image Quality> ▶ <Special Processing> ▶ <Low Humidity Mode> ▶ Select the mode ▶  ▶ 

NOTE



- If <Low Humidity Mode> is specified, print density may be lower or uneven when the machine is used in an environment with high humidity.

<Reduce Ghosting 1>

When you print on large size paper after printing on small size paper, afterimages may appear in blank areas. In this case, setting this item to <On> may solve the problem.

<Off> +
<On>



<Menu> ▶ <Adjustment/Maintenance> ▶ <Adjust Image Quality> ▶ <Special Processing> ▶ <Reduce Ghosting 1> ▶ <On> ▶  ▶ 

NOTE



- If you set to <On>, the printing speed may be slower.

<Reduce Condensation (Consec. 2-Sd Print)>

If the printed images are faint due to moisture condensation when performing 2-sided printing, setting to other than <Off> may solve the problem.

<Off> +
<On>



<Menu> ▶ <Adjustment/Maintenance> ▶ <Adjust Image Quality> ▶ <Special Processing> ▶ <Reduce Condensation (Consec. 2-Sd Print)> ▶ <On> ▶  ▶ 

NOTE

- If you set to <On>, the printing speed will be slower.

<Rdc. Wrinkles(Humidity)/Streaks>

If printouts have creases when damp paper is used or if streaks appear in the leading edge of paper when images with halftones such as photos are printed, setting to <On> may solve the problem.

<Off> +
<On>



<Menu> ▶ <Adjustment/Maintenance> ▶ <Adjust Image Quality> ▶ <Special Processing> ▶ <Rdc. Wrinkles(Humidity)/Streaks> ▶ <On> ▶  ▶ 

NOTE



- If you set to <On>, the printing speed will be slower.

<Quiet Mode>

When printing sounds bother you, set this item to <On>.

<Off> +
<On>



<Menu> ▶ <Adjustment/Maintenance> ▶ <Adjust Image Quality> ▶ <Special Processing> ▶ <Quiet Mode> ▶ <On> ▶  ▶ 

NOTE



- If you set to <On>, the printing speed will be slower.

<Correct Blurry Image>

Streaks may appear on printouts depending on the paper type or the environmental conditions. In this case, setting this item may solve the problem. The improvement effect is weakest with <Mode 1> and strongest with <Mode 4>.

<Off>
<Mode 1> +
<Mode 2>
<Mode 3>
<Mode 4>



<Menu> ▶ <Adjustment/Maintenance> ▶ <Adjust Image Quality> ▶ <Special Processing> ▶ <Correct Blurry Image> ▶ Select the mode ▶  ▶ 

NOTE

- Setting a stronger improvement effect may result in lighter print density or slower printing speed. It may also result in less sharp edges and rougher details.

<Rdc Blnk Space Dark. After Rplc Cart.>

Immediately after replacing toner cartridges with new ones, black streaks may appear on printouts or printing on heavy paper may result in grayish printouts. In this case, setting this item to <On> may solve the problem.

<Off> +
<On>



<Menu> ▶ <Adjustment/Maintenance> ▶ <Adjust Image Quality> ▶ <Special Processing> ▶ <Rdc Blnk Space Dark. After Rplc Cart.> ▶ <On> ▶  ▶ 

NOTE

- If you set to <On>, the setting will become effective with next replacement of toner cartridges.
- Immediately after cartridge replacement, a certain amount of time is required for toner to be evenly distributed inside the cartridge.

<Maintenance>

The cleaning functions are listed with descriptions. Default settings are marked with a dagger (†).

▶<Clean Fixing Assembly>(P. 295)

▶<Control Condensation>(P. 295)

<Clean Fixing Assembly>

Clean the fixing assembly after a toner cartridge is replaced or if black streaks appear on printouts. ▶<Cleaning the Fixing Assembly>(P. 344)

<Control Condensation>

When the temperature changes rapidly in the environment where the machine is installed, condensation occurs, which may cause fading or bleeding in images and text. Select <On> to remove dew condensation in the machine. When selecting <On>, specify whether to restrict jobs.

<Off> †

<On>

<Allow Job Printing During Process> †

<Do Not Allow Job Printing During Process>



<Menu> ▶ <Adjustment/Maintenance> ▶ <Maintenance> ▶ <Control Condensation> ▶ <On> ▶
Check the message ▶ ▶ Select the item ▶ ▶ <Yes> ▶

! IMPORTANT

- While condensation removal is being performed, printing may not be performed properly and blank paper may be output.
- If you set to <On>, you need to keep the machine turned ON to maintain the effect of condensation removal.
- If you set to <On>, the setting of Auto Shutdown Time is disabled. ▶<Powering OFF at a Fixed Time>(P. 85)

<Function Settings>

7YX2-05R

NOTE

Asterisks (*)

- Settings marked with an asterisk (*) may not be displayed depending on the model you are using, options, or other setting items.

Item	Description
▶<Common>(P. 297)	This section describes settings common to each function.
▶<Printer>(P. 300)	This section describes how to specify printer settings.
▶<Receive>(P. 325)	This section describes how to specify settings for receiving I-Faxes.
▶<Secure Print>(P. 327) *	This section describes the settings for the Secure Print.

<Common>

All the items related to settings common to each function are listed with descriptions. Default settings are marked with a dagger (†).

▶<Paper Feed Settings>(P. 297)

▶<Print Settings>(P. 299)

NOTE

Asterisks (*)

- Settings marked with an asterisk (*) may not be displayed depending on the model you are using, options, or other setting items.

<Paper Feed Settings>

Configure paper feed settings.

<Drawer Auto Selection On/Off>

Enable or disable the automatic drawer selection feature for the paper sources. If automatic drawer selection is set to <On> when printing documents, the machine automatically selects a paper source that is loaded with the appropriate paper size. Also, when the paper runs out, this setting enables continuous printing by switching from one paper source to another that is loaded with the same paper size. ▶<Automatically Selecting an Appropriate Paper Source for Each Function>(P. 127)

<Printer>

<Multi-Purpose Tray>

<Off>

<On> †

<Drawer 1>

<Off>

<On> †

<Drawer 2>* †

<Off>

<On> †

<Receive>

<Multi-Purpose Tray>

<Off> †

<On>

<Drawer 1>

<Off>

<On> †

<Drawer 2>* †

<Off>

<On> †



<Other>

<Multi-Purpose Tray>
<Off> †
<On>
<Drawer 1>
<Off>
<On> †
<Drawer 2>*
<Off>
<On> †

<Switch Paper Feed Method>

Specify this setting when you print a document on paper with logos. In general use, to print on paper with logos, you need to change how the paper loaded in the paper source is facing depending on whether you are performing 1- or 2-sided printing. However, if you change the setting to <Print Side Priority>, you can just load the paper with the logo side facing down for 1-sided printing in the same way as for 2-sided printing. For more information, see **Loading Preprinted Paper(P. 113)** .

<Multi-Purpose Tray>
<Speed Priority> †
<Print Side Priority>
<Drawer 1>
<Speed Priority> †
<Print Side Priority>
<Drawer 2> *
<Speed Priority> †
<Print Side Priority>

 <Menu> ▶ <Function Settings> ▶ <Common> ▶ <Paper Feed Settings> ▶ <Switch Paper Feed Method> ▶ Select the paper source ▶ Select <Speed Priority> or <Print Side Priority> ▶ 

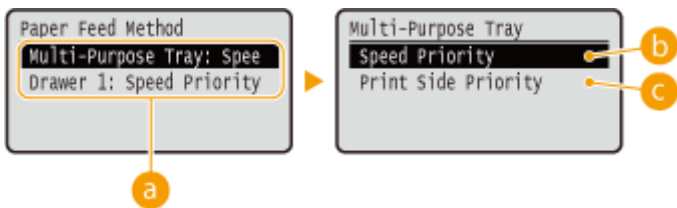

a Paper Sources

Select the paper source that you want to change the setting for.

b <Speed Priority>

When using paper that has been preprinted with a logo, you need to change how it is facing when you perform 1-sided and 2-sided printing.



NOTE:

- We recommend selecting <Speed Priority> if you do not need to consider which side to print on.

<Print Side Priority>

To print on a specific side of paper, you do not need to flip over paper in the paper source whether 1- or 2-sided printing is selected.

NOTE:

- If <Print Side Priority> is set for a paper source that is loaded with paper you cannot use for 2-sided printing ( **Available Paper(P. 379)**), <Speed Priority> is applied to the paper source instead. In this case, you need to load the paper in the same way as when <Speed Priority> is selected ( **Loading Preprinted Paper(P. 113)**).
- 1-sided printing speed may be slower when <Print Side Priority> is selected.

<Print Settings>

Configure printing operation settings.

<Auto Delete Suspended Jobs>

You can configure so that if the machine stops printing a job due to an error, the job will be automatically deleted after a specified period of time.

<Off> 

<On>

0 to 5  to 240 (min.)



<Menu> ▶ <Function Settings> ▶ <Common> ▶ <Print Settings> ▶ <Auto Delete Suspended Jobs> ▶ <On> ▶ Enter the time until deletion ▶  ▶ Restart the machine

<Printer>

All the settings related to the printer are listed with descriptions. Default settings are marked with a dagger (†).

▶<Printer Settings>(P. 300)

▶<PDL Selection (Plug and Play)>(P. 323)

NOTE

Asterisks (*)

- Settings marked with "*1" may not be displayed depending on the model you are using, options, or other setting items.
- Settings marked with "*2" cannot be imported or exported.

Priority of settings

- If a print setting is specified both from the printer driver and the operation panel of the machine, the specification from the printer driver overrides that from the operation panel. The specification from the operation panel becomes effective in some specific cases, such as when performing PS/PCL printing and printing from UNIX or other operating system that does not support printer drivers.



<Printer Settings>

Configure settings about printing and printer operations.

<Action When Free Paper Size Mismatch>

When the paper size of each paper source is set to <Free Size> in <Paper Settings>, you can specify the operation that is to be performed when the size of the loaded paper is significantly different from the setting in the printer driver.

<Multi-Purpose Tray>

<Force Output> †

<Display Error>

<Drawer 1>

<Force Output> †

<Display Error>

<Drawer 2> *1

<Force Output> †

<Display Error>



<Menu> ▶ <Function Settings> ▶ <Printer> ▶ <Printer Settings> ▶ <Action When Free Paper Size Mismatch> ▶ Select a paper source ▶ Select <Force Output> or <Display Error> ▶ 

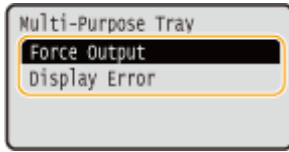

<Force Output>

Continues printing even if the size setting in the printer driver is significantly different from the size of the loaded paper.

<Display Error>

Displays an error message and stops printing when the setting in the printer driver is significantly different from the size of the loaded paper.

! IMPORTANT



- If the printer driver's settings do not match the size and type of loaded paper with <On> selected, a paper jam or printing error may occur.

<Copies>

Set the number of copies to print.

1  to 999





<Menu> ▶ <Function Settings> ▶ <Printer> ▶ <Printer Settings> ▶ <Copies> ▶ Set the number of copies to print ▶  ▶ 

<2-Sided Printing>

Select whether to make 2-sided printouts.

<Off> 
<On>



<Menu> ▶ <Function Settings> ▶ <Printer> ▶ <Printer Settings> ▶ <2-Sided Printing> ▶ Select <Off> or <On> ▶ 

<Default Paper>

Set the default paper size and type. Printing will be performed with paper of the size and type set here when you want to print from an OS not supporting printer drivers or from a mobile device or other device not supporting paper size and type settings.  **Available Paper(P. 379)**



<Menu> ▶ <Function Settings> ▶ <Printer> ▶ <Printer Settings> ▶ <Default Paper> ▶ Select the paper size ▶ Select the paper type ▶ 

<Paper Size Override>

Select whether to switch between printing on A4 and Letter size paper if one of these paper sizes is loaded but the other is not. When you select <On>, if you specify A4 size paper to print from the computer but A4 size paper is not loaded in the machine, it will print your document on Letter size paper.

<Off> +
<On>



<Menu> ▶ <Function Settings> ▶ <Printer> ▶ <Printer Settings> ▶ <Paper Size Override> ▶ Select <Off> or <On> ▶ 

NOTE

- You can specify print settings, such as the number of copies or 1-sided/2-sided printing, from an application or the printer driver. However, the <Paper Size Override> setting can only be specified on the machine.

<Print Quality>

You can change settings related to print quality.



<Density> *1

Adjust the toner density.

<Density>
17 Levels

<Density (Fine Adjust)>
<High>/<Medium>/<Low>
17 Levels



<Menu> ▶ <Function Settings> ▶ <Printer> ▶ <Printer Settings> ▶ <Print Quality> ▶ <Density> ▶ <Density> ▶ Adjust the density ▶  ▶ <Apply> ▶ 

NOTE

- You can use <Density (Fine Adjust)> to adjust the toner density to three density levels: high density, medium density, and low density.

NOTE:

- When <Toner Save> is set to <On>, you cannot set this item.

<Toner Save>

You can save toner consumption. Select <On> when you want to check the layout or other appearance characteristics before proceeding to final printing of a large job.

<Off> †
<On>





<Menu> ▶ <Function Settings> ▶ <Printer> ▶ <Printer Settings> ▶ <Print Quality> ▶ <Toner Save> ▶ Select <Off> or <On> ▶ 

<Image Refinement>

Enable or disable the smoothing mode in which the edges of characters and graphics are smoothly printed.

<Off>
<On> †



<Menu> ▶ <Function Settings> ▶ <Printer> ▶ <Printer Settings> ▶ <Print Quality> ▶ <Image Refinement> ▶ Select <Off> or <On> ▶ 

<Resolution>

Specify the resolution to be used for print data processing.

<1200 dpi>
<600 dpi> †



<Menu> ▶ <Function Settings> ▶ <Printer> ▶ <Printer Settings> ▶ <Print Quality> ▶ <Resolution> ▶ Select <1200 dpi> or <600 dpi> ▶ 



<Layout>

Specify the page layout settings such as binding position and margin values.

<Binding Location>

If you are binding the printouts with a binding tool such as a stapler, use this item to specify whether to bind on the long or short edge. Specify the setting of this item in combination with <Gutter>, which specifies the binding margin to apply to the binding position.

<Long Edge> †
<Short Edge>

 <Menu> ▶ <Function Settings> ▶ <Printer> ▶ <Printer Settings> ▶ <Layout> ▶ <Binding Location> ▶ Select <Long Edge> or <Short Edge> ▶ 

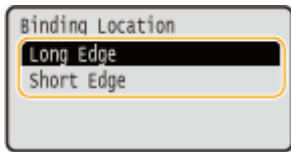

<Long Edge>

Specify this to bind on the long edge of paper.



<Short Edge>



Specify this to bind on the short edge of paper.



<Gutter>

Shift the print position to adjust the binding margin to apply to the binding edge specified by <Binding Location>. The value "00.0" exerts no effect on the binding margin.



-50.0 to 00.0 [†] to +50.0 (mm)

 <Menu> ▶ <Function Settings> ▶ <Printer> ▶ <Printer Settings> ▶ <Layout> ▶ <Gutter> ▶ Specify the binding margin ▶  ▶ 



a Entering the setting value

Specify the print position shift direction and shift width. Whether the setting value is a "+" or "-" value determines the binding edge along which to adjust the binding margin. The margin width can be adjusted in 0.5 mm increments. ▶ **Basic Operation(P. 95)**

Setting Value	Long Edge	Short Edge
A value with a "+" sign	Left edge of paper 	Top edge of paper 
A value with a "-" sign	Right edge of paper	Bottom edge of paper

Setting Value	Long Edge	Short Edge

<Offset Short Edge/Offset Long Edge>

Irrespective of the paper source, you can shift the print position in units of "0.5 mm" for all print jobs.

-50.0 to 00.0 + to +50.0 (mm)

<Menu> ▶ <Function Settings> ▶ <Printer> ▶ <Printer Settings> ▶ <Layout> ▶ Select the combination of adjustment direction and printing side ▶ Specify the offset value ▶ ▶

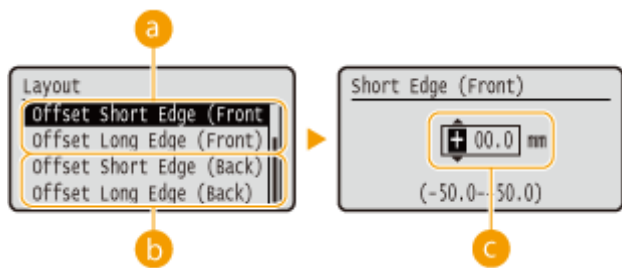

a <Offset Short Edge (Front)>/<Offset Long Edge (Front)>

Shifts the print position on the side of paper facing up.

b <Offset Short Edge (Back)>/<Offset Long Edge (Back)>

Shifts the print position on the side of paper facing down.

c Entering the setting value

For <Offset Short Edge (Front)>/<Offset Short Edge (Back)>, specify a value with a "+" sign to shift the print position in the left-to-right direction. For <Offset Long Edge (Front)>/<Offset Long Edge (Back)>, specify a value with a "+" sign to shift the print position in the up-to-down direction. To shift in the reverse direction, specify a value with a "-" sign. **Basic Operation(P. 95)**

<Offset Short Edge (Front)>
<Offset Short Edge (Back)>

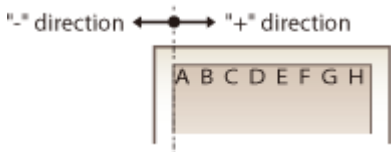

<Offset Long Edge (Front)>
<Offset Long Edge (Back)>

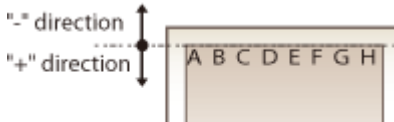

<Auto Error Skip>

Printing stops if a certain error occurs in the process. However, if you set this item to <On>, the certain error will be skipped and printing can continue. Normally, set this item to <Off>.

<Off> †
<On>



<Menu> ▶ <Function Settings> ▶ <Printer> ▶ <Printer Settings> ▶ <Auto Error Skip> ▶ Select <Off> or <On> ▶

<Timeout>

Set the time period after which the current print job is automatically canceled in the case of a print data reception interruption.

5 to 15 † to 300 (sec.)



<Menu> ▶ <Function Settings> ▶ <Printer> ▶ <Printer Settings> ▶ <Timeout> ▶ Set the time period ▶ ▶

<Personality>

Specify the mode in which the machine should operate when the format of document data is unknown.

<Auto> †
<PS>*1
<PCL>
<PDF>
<XPS>
<Imaging>



<Menu> ▶ <Function Settings> ▶ <Printer> ▶ <Printer Settings> ▶ <Personality> ▶ Select the Personality mode ▶

<Escape Tray Mode>

Specify whether to feed paper from the multi-purpose tray when the appropriate paper is not loaded in the paper drawer while Auto Select Paper is enabled.

<Off> †
<On>





<Menu> ▶ <Function Settings> ▶ <Printer> ▶ <Printer Settings> ▶ <Escape Tray Mode> ▶ Select <Off> or <On> ▶

<Speed/Print Side Priority for 2-Sided>

Specify whether to process the last page using 1-sided printing when processing a document containing an odd number of pages using 2-sided printing.

<Speed Priority> †
<Print Side Priority>



<Menu> ▶ <Function Settings> ▶ <Printer> ▶ <Printer Settings> ▶ <Speed/Print Side Priority for 2-Sided> ▶ Select <Speed Priority> or <Print Side Priority> ▶ 

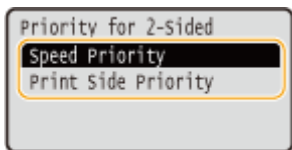

<Speed Priority>

Processes the last page using 1-sided printing.

<Print Side Priority>

Also processes the last page using 2-sided printing.

NOTE

When a document containing an even number of pages is ended with 1-sided printing

- When <Speed Priority> is selected, the last page that is blank or unprintable is processed using 1-sided printing even if the document consists of the even number of pages.

When you use paper that has been preprinted with a logo

- If <Speed Priority> is selected and the last page is processed using 1-sided printing, the page orientation or print side may differ from that of other pages. In such a case, select <Print Side Priority>.

<Prioritize Multi-Purpose Tray>

Specify whether to feed paper from the multi-purpose tray when Auto Select Paper is enabled. If <On> is selected, paper is fed from the multi-purpose tray when paper of the same size and same type is loaded in both the multi-purpose tray and paper drawer.

<Off> †
<On>



<Menu> ▶ <Function Settings> ▶ <Printer> ▶ <Printer Settings> ▶ <Prioritize Multi-Purpose Tray> ▶ Select <Off> or <On> ▶ 

NOTE

- This setting is only available when <Escape Tray Mode> is set to <Off>.

<Check Paper Size in Tray>

Specify whether to cancel the printing when the paper size in the loaded paper is different from the one in the printer driver.

<Off>
<On> †



<Menu> ▶ <Function Settings> ▶ <Printer> ▶ <Printer Settings> ▶ <Check Paper Size in Tray> ▶ Select <Off> or <On> ▶ 

<Recovery Printing>

If printing is interrupted due to an error such as a paper jam, printing ordinarily restarts from the page on which the error occurred after the error has been resolved. When <Off> is selected, the page on which an error occurred is skipped, and printing restarts from the next page.

<Off>
<On> †



<Menu> ▶ <Function Settings> ▶ <Printer> ▶ <Printer Settings> ▶ <Recovery Printing> ▶ Select <Off> or <On> ▶ 

IMPORTANT

When <Off> is selected

- The page may not be printed depending on the timing at which an error occurred.
- If an error occurs during 2-sided printing, both of the corresponding pages may not be printed.

<UFR II>

You can change the settings that become effective when printing from the UFR II printer driver.

<Halftones>



You can select the printing method used to reproduce halftones (the intermediate range between the lighter and darker areas of an image) for optimal image quality.

<Resolution/Gradation>

Select a method used to reproduce halftones. This option can be specified for each image type in any one document.

<Text>
<Resolution> †
<Color Tone>
<Gradation>

- <High Resolution>
- <Graphics>**
- <Resolution>
- <Color Tone> †
- <Gradation>
- <High Resolution>
- <Image>**
- <Resolution>
- <Color Tone> †
- <Gradation>
- <High Resolution>

 <Menu> ▶ <Function Settings> ▶ <Printer> ▶ <Printer Settings> ▶ <UFR II> ▶ <Halftones> ▶ <Resolution/Gradation> ▶ Select the type of image ▶ Select the halftone reproduction method ▶ 



a Type of image

Select the object for which to change the setting. <Text> represents letters and characters, <Graphics> represents lines and figures, and <Image> represents photos and images.

b Setting value

<Resolution>

Produces a fine print with clear edges of text. It is suitable for printing characters and fine lines.

<Color Tone>

Produces a sharp print with strong contrast of lightness and darkness. It is suitable for printing image data such as photo image data.

<Gradation>

Produces a print with smooth gradation or smooth edges. It is suitable for printing figures or graphs containing gradation areas.

<High Resolution>

As compared to <Resolution>, this produces a finer print but quality stability is slightly lower. It is suitable to obtain a print of character data or fine line data or CAD data with sharp edges.

<Paper Save>

Specify whether to disable a blank page in print data from being output.

- <Off>
- <On> †



<Menu> ▶ <Function Settings> ▶ <Printer> ▶ <Printer Settings> ▶ <UFR II> ▶ <Paper Save> ▶ Select <Off> or <On> ▶ 

<PCL>

Specify the PCL printing settings such as page layout and print quality.

<Paper Save>

Specify whether to disable a blank page in print data from being output.

<Off> +
<On>



<Menu> ▶ <Function Settings> ▶ <Printer> ▶ <Printer Settings> ▶ <PCL> ▶ <Paper Save> ▶ Select <Off> or <On> ▶ 

<Orientation>

Select <Portrait> (vertical orientation) or <Landscape> (horizontal orientation) for the page orientation.

<Portrait> +
<Landscape>



<Menu> ▶ <Function Settings> ▶ <Printer> ▶ <Printer Settings> ▶ <PCL> ▶ <Orientation> ▶ Select <Portrait> or <Landscape> ▶ 

Specify the font to use by selecting a corresponding font ID number. You can print the PCL font list with font samples from the operation panel.  **PCL Font List(P. 362)**

0 + to 54



<Menu> ▶ <Function Settings> ▶ <Printer> ▶ <Printer Settings> ▶ <PCL> ▶ ▶ Select the font number ▶  ▶ 

<Point Size> *1

Set the font size in points, adjustable in 0.25 increments. You can specify this setting only when a proportionally-spaced scalable font is selected in .

4.00 to 12.00 + to 999.75 (point)



<Menu> ▶ <Function Settings> ▶ <Printer> ▶ <Printer Settings> ▶ <PCL> ▶ <Point Size> ▶ Specify the point size ▶  ▶ 

<Pitch> *1

Set the font pitch, or cpi (characters per inch), adjustable in 0.01 increments. You can specify this setting only when a fixed-pitch scalable font or a bitmap font is selected in .

0.44 to 10.00  to 99.99 (cpi)



<Menu> ▶ <Function Settings> ▶ <Printer> ▶ <Printer Settings> ▶ <PCL> ▶ <Pitch> ▶ Specify the pitch value ▶  ▶ 

<Form Lines>

Set the number of lines printed on one page from 5 to 128. This setting is automatically changed according to the settings specified in <Default Paper Size> and <Orientation>.

5 to 64  to 128 (lines)



<Menu> ▶ <Function Settings> ▶ <Printer> ▶ <Printer Settings> ▶ <PCL> ▶ <Form Lines> ▶ Specify the number of lines ▶  ▶ 

<Character Code>

Select the character code that is most suited for the computer you send print data from. The specified setting is ignored when the character code is controlled by the font specified in .

<DESKTOP>	<PC8> 
<ISO11>	<PC850>
<ISO15>	<PC852>
<ISO17>	<PC858>
<ISO21>	<PC8DN>
<ISO4>	<PC8TK>
<ISO6>	<PIFONT>
<ISO60>	<PSMATH>
<ISO69>	<PSTEXT>
<ISOL1>	<ROMAN8>
<ISOL2>	<ROMAN9>
<ISOL5>	<VNINTL>
<ISOL6>	<VNMATH>
<ISOL9>	<VNUS>
<LEGAL>	<WIN30>
<MATH8>	<WINBALT>
<MCTEXT>	<WINL1>
<MSPUBL>	<WINL2>

<PC1004> <WINL5>
<PC775>



<Menu> ▶ <Function Settings> ▶ <Printer> ▶ <Printer Settings> ▶ <PCL> ▶ <Character Code> ▶ Select the character code ▶

<Custom Paper>

Select whether to set a custom paper size. Select <On> to set the dimensions of the paper in <X dimension> and <Y dimension>.

<Off> †
<On>



<Menu> ▶ <Function Settings> ▶ <Printer> ▶ <Printer Settings> ▶ <PCL> ▶ <Custom Paper> ▶ Select <Off> or <On> ▶

<Unit of Measure> *1

Select the unit of measurement to use to set a custom paper size.

<Millimeter> †
<Inch>



<Menu> ▶ <Function Settings> ▶ <Printer> ▶ <Printer Settings> ▶ <PCL> ▶ <Unit of Measure> ▶ Select <Millimeter> or <Inch> ▶

<X dimension> *1

Specify the horizontal dimension (short edge) of the custom paper.

77 to 216 † (mm)





<Menu> ▶ <Function Settings> ▶ <Printer> ▶ <Printer Settings> ▶ <PCL> ▶ <X dimension> ▶ Specify the dimension ▶ ▶

<Y dimension> *1

Specify the vertical dimension (long edge) of the custom paper.

127 to 355 † (mm)

 <Menu> ▶ <Function Settings> ▶ <Printer> ▶ <Printer Settings> ▶ <PCL> ▶ <Y dimension> ▶ Specify the dimension ▶  ▶ 

<Append CR to LF>

Select whether to append a carriage return (CR) when the machine receives a line feed code (LF). If <Yes> is selected, the print position moves to the beginning of the next line when the machine receives an LF code. If <No> is selected, the print position moves to the next line, just under the received LF code.

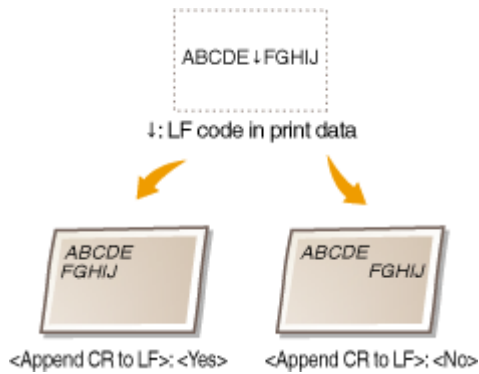

<Yes>
<No> †

 <Menu> ▶ <Function Settings> ▶ <Printer> ▶ <Printer Settings> ▶ <PCL> ▶ <Append CR to LF> ▶ Select <Yes> or <No> ▶ 

<Enlarge A4 Print Width>

Select whether to expand the width of the printable area of A4 size paper in portrait orientation to that of Letter size.

<Off> †
<On>

 <Menu> ▶ <Function Settings> ▶ <Printer> ▶ <Printer Settings> ▶ <PCL> ▶ <Enlarge A4 Print Width> ▶ Select <Off> or <On> ▶ 

<Halftones>

You can select the printing method used to reproduce halftones (the intermediate range between the lighter and darker areas of an image) for optimal image quality.

<Resolution/Gradation>

Select a method used to reproduce halftones. This option can be specified for each image type in any one document.

<Text>
<Resolution> †

<Color Tone>
<Gradation>
<High Resolution>
<Graphics>
<Resolution>
<Color Tone> †
<Gradation>
<High Resolution>
<Image>
<Resolution>
<Color Tone> †
<Gradation>
<High Resolution>

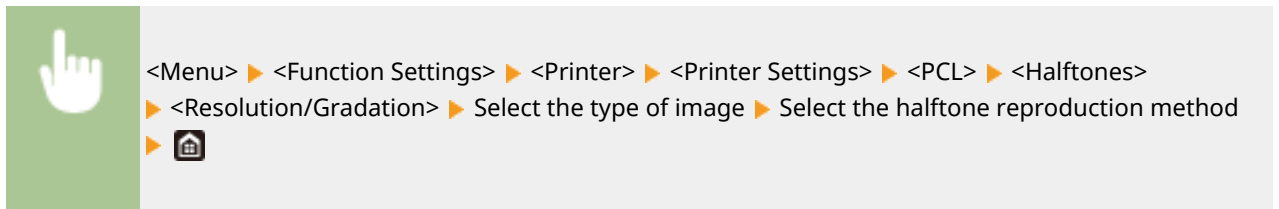

a Type of image

Select the object for which to change the setting. <Text> represents letters and characters, <Graphics> represents lines and figures, and <Image> represents photos and images.

b Setting value

<Resolution>

Produces a fine print with clear edges of text. It is suitable for printing characters and fine lines.

<Color Tone>

Produces a sharp print with strong contrast of lightness and darkness. It is suitable for printing image data such as photo image data.

<Gradation>

Produces a print with smooth gradation or smooth edges. It is suitable for printing figures or graphs containing gradation areas.

<High Resolution>

As compared to <Resolution>, this produces a finer print but quality stability is slightly lower. It is suitable to obtain a print of character data or fine line data or CAD data with sharp edges.

<PS> *1



Specify the PS printing settings such as page layout and print quality.

<Job Timeout>

This setting enables you to specify the amount of time before a job times out. If a job has not finished within the set time limit, the job automatically cancels.

0 † to 3600 (sec.)



<Menu> ▶ <Function Settings> ▶ <Printer> ▶ <Printer Settings> ▶ <PS> ▶ <Job Timeout>
 ▶ Specify the seconds for job timeout ▶  ▶ 

<Print PS Errors>

This setting determines whether an error page is printed when an error is encountered.

<Off> †
 <On>



<Menu> ▶ <Function Settings> ▶ <Printer> ▶ <Printer Settings> ▶ <PS> ▶ <Print PS Errors>
 ▶ Select <Off> or <On> ▶ 

<Halftones>

You can select the printing method used to reproduce halftones (the intermediate range between the lighter and darker areas of an image) for optimal image quality.



<Resolution/Gradation>

Select a method used to reproduce halftones. This option can be specified for each image type in any one document.

<Text>
 <Resolution> †
 <Gradation>
 <High Resolution>

<Graphics>
 <Resolution> †
 <Gradation>
 <High Resolution>

<Image>
 <Resolution> †
 <Gradation>
 <High Resolution>

 <Menu> ▶ <Function Settings> ▶ <Printer> ▶ <Printer Settings> ▶ <PS> ▶ <Halftones> ▶ <Resolution/Gradation> ▶ Select the type of image ▶ Select the halftone reproduction method ▶ 

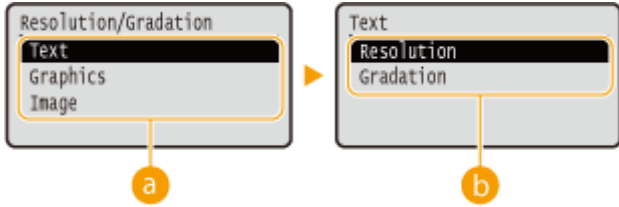

a Type of image

Select the object for which to change the setting. <Text> represents letters and characters, <Graphics> represents lines and figures, and <Image> represents photos and images.

b Setting value

<Resolution>

Produces a print with smooth gradation or smooth edges. It is suitable for printing figures or graphs containing gradation areas.

<Gradation>

Produces a sharp print with strong contrast of lightness and darkness. It is suitable for printing image data such as photo image data.



<High Resolution>

Produces a fine print with clear edges of text. It is suitable for printing characters and fine lines.

<Grayscale Conversion>

Specify the way of printing color data in black and white.

<sRGB>
 <NTSC> †
 <Uniform RGB>

 <Menu> ▶ <Function Settings> ▶ <Printer> ▶ <Printer Settings> ▶ <PS> ▶ <Grayscale Conversion> ▶ Select the type of grayscale conversion ▶ 

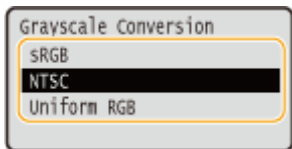

<sRGB>

Prints in black and white with emphasis on color differences so that a smooth gradation is achieved.

<NTSC>

Prints in black and white so that the resulting image looks like a black and white television picture (of the NTSC system).

<Uniform RGB>

Prints in black and white so that R, G, and B are uniformly converted to the same gray level by using only brightness as the reference.

<PS Password Settings>

You can specify the password that restricts the use of the control command prepared by the PS printer.

<SystemParamsPassword>
<StartJobPassword>



<Menu> ▶ <Function Settings> ▶ <Printer> ▶ <Printer Settings> ▶ <PS> ▶ <PS Password Settings> ▶ Select <SystemParamsPassword> or <StartJobPassword> ▶ Enter the password ▶ <Apply> ▶ Enter the password (Confirm) ▶ <Apply> ▶ 

NOTE:

- <SystemParamsPassword> is a password that allows changes to the system parameter, and <StartJobPassword> is a password that allows startjob, exitserver operator to perform. For more information, check PostScript language specifications.
- If <StartJobPassword> is set but <SystemParamsPassword> is not set, password check will not be performed while performing startjob, exitserver operator.

<Imaging Settings>

You can change the print settings that will apply when printing image files (JPEG/TIFF).

<Halftones>

You can change the printing method used to reproduce halftones (the intermediate range between the lighter and darker areas of an image) for optimal image quality.

<Gradation> †
<Resolution>
<High Resolution>



<Menu> ▶ <Function Settings> ▶ <Printer> ▶ <Printer Settings> ▶ <Imaging Settings> ▶ <Halftones> ▶ Select the halftone reproduction method ▶ 

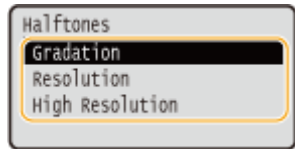

<Gradation>

Produces a sharp print with strong contrast of lightness and darkness. It is suitable for printing image data such as photo image data.

<Resolution>

Produces a print with smooth gradation or smooth edges. It is suitable for printing figures or graphs containing gradation areas.

<High Resolution>

Produces a fine print with clear edges of text. It is suitable for printing characters and fine lines.

<PDF>

You can change settings for PDF files.

<Enlarge/Reduce to Fit Paper Size>

Specify whether to enlarge or reduce the original according to the print range of paper. Note that size enlargement/reduction will not affect the aspect ratio of the original.

<Off> +
<On>



<Menu> ▶ <Function Settings> ▶ <Printer> ▶ <Printer Settings> ▶ <PDF> ▶ <Enlarge/Reduce to Fit Paper Size> ▶ Select <Off> or <On> ▶ 

<Enlarge Print Area>

Specify whether to extend the print range to the paper size.

<Off> +
<On>



<Menu> ▶ <Function Settings> ▶ <Printer> ▶ <Printer Settings> ▶ <PDF> ▶ <Enlarge Print Area> ▶ Select <Off> or <On> ▶ 

NOTE:

- If you specify <On>, it may occur that edge-adjacent portions of page are not printed or that printouts come out partially smudged depending on the original.

<N on 1>

Specify whether to shrink multiple pages and print them on one page in such arrangement that the first page is positioned at top left. For example, to print 4 pages onto a single sheet, select <4 on 1>.

<Off> +
<2 on 1>
<4 on 1>
<6 on 1>
<8 on 1>
<9 on 1>
<16 on 1>



<Menu> ▶ <Function Settings> ▶ <Printer> ▶ <Printer Settings> ▶ <PDF> ▶ <N on 1> ▶ Select the number of pages to be combined ▶ 

<Print Comments>

Specify whether to print comments. If you specify <Auto>, comments in PDF files will be printed.

<Off>
 <Auto> †

<Menu> ▶ <Function Settings> ▶ <Printer> ▶ <Printer Settings> ▶ <PDF> ▶ <Print Comments>
 ▶ Select <Off> or <Auto> ▶

<Halftones>

You can select the printing method used to reproduce halftones (the intermediate range between the lighter and darker areas of an image) for optimal image quality.

<Resolution/Gradation>

Select a method used to reproduce halftones. This option can be specified for each image type in any one document.

<Text>
 <Resolution> †
 <Gradation>
 <High Resolution>

<Graphics>
 <Resolution> †
 <Gradation>
 <High Resolution>

<Image>
 <Resolution> †
 <Gradation>
 <High Resolution>

<Menu> ▶ <Function Settings> ▶ <Printer> ▶ <Printer Settings> ▶ <PDF> ▶ <Halftones> ▶ <Resolution/Gradation> ▶ Select the type of image ▶ Select the halftone reproduction method ▶

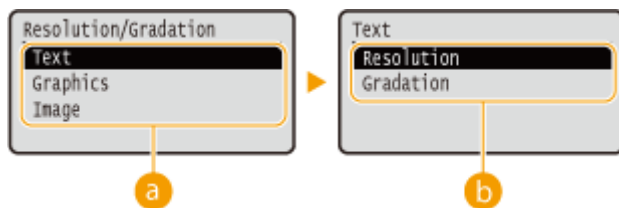

a Type of image

Select the object for which to change the setting. <Text> represents letters and characters, <Graphics> represents lines and figures, and <Image> represents photos and images.

b Setting value

<Resolution>

Produces a print with smooth gradation or smooth edges. It is suitable for printing figures or graphs containing gradation areas.

<Gradation>

Produces a sharp print with strong contrast of lightness and darkness. It is suitable for printing image data such as photo image data.

<High Resolution>

Produces a fine print with clear edges of text. It is suitable for printing characters and fine lines.

<Grayscale Conversion>

Specify the way of printing color data in black and white.

<sRGB>
 <NTSC> †
 <Uniform RGB>



<Menu> ▶ <Function Settings> ▶ <Printer> ▶ <Printer Settings> ▶ <PDF> ▶ <Grayscale Conversion> ▶ Select the type of grayscale conversion ▶

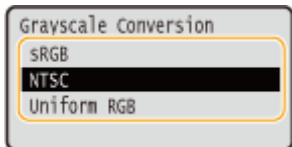

<sRGB>

Prints in black and white with emphasis on color differences so that a smooth gradation is achieved.

<NTSC>

Prints in black and white so that the resulting image looks like a black and white television picture (of the NTSC system).

<Uniform RGB>

Prints in black and white so that R, G, and B are uniformly converted to the same gray level by using only brightness as the reference.

<XPS>

You can change settings for XPS files.

<Halftones>

You can select the printing method used to reproduce halftones (the intermediate range between the lighter and darker areas of an image) for optimal image quality.

<Resolution/Gradation>



Select a method used to reproduce halftones. This option can be specified for each image type in any one document.

<Text>
 <Resolution> †
 <Gradation>
 <High Resolution>

```

<Graphics>
  <Resolution> †
  <Gradation>
  <High Resolution>

<Image>
  <Resolution> †
  <Gradation>
  <High Resolution>
    
```

 <Menu> ▶ <Function Settings> ▶ <Printer> ▶ <Printer Settings> ▶ <XPS> ▶ <Halftones> ▶ <Resolution/Gradation> ▶ Select the type of image ▶ Select the halftone reproduction method ▶ 

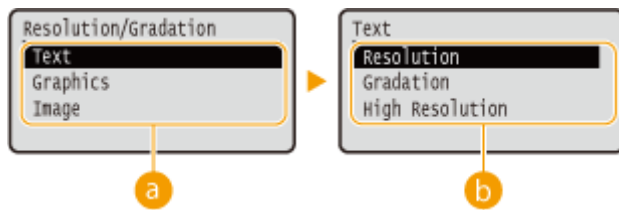

a Type of image

Select the object for which to change the setting. <Text> represents letters and characters, <Graphics> represents lines and figures, and <Image> represents photos and images.

b Setting value

<Resolution>

Produces a print with smooth gradation or smooth edges. It is suitable for printing figures or graphs containing gradation areas.

<Gradation>

Produces a sharp print with strong contrast of lightness and darkness. It is suitable for printing image data such as photo image data.

<High Resolution>

Produces a fine print with clear edges of text. It is suitable for printing characters and fine lines.

<Grayscale Conversion>



Specify the way of printing color data in black and white.

```

<Text>
  <sRGB>
  <NTSC> †
  <Uniform RGB>

<Graphics>
  <sRGB>
  <NTSC> †
  <Uniform RGB>
    
```

<Image>
 <sRGB>
 <NTSC> †
 <Uniform RGB>

 <Menu> ▶ <Function Settings> ▶ <Printer> ▶ <Printer Settings> ▶ <XPS> ▶ <Grayscale Conversion> ▶ Select the type of image ▶ Select the type of grayscale conversion ▶ 

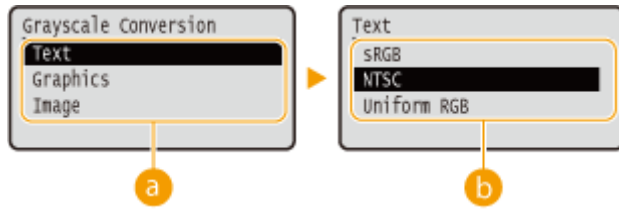

a Type of image

Select the object for which to change the setting. <Text> represents letters and characters, <Graphics> represents lines and figures, and <Image> represents photos and images.

b Type of grayscale conversion

<sRGB>

Prints in black and white with emphasis on color differences so that a smooth gradation is achieved.

<NTSC>

Prints in black and white so that the resulting image looks like a black and white television picture (of the NTSC system).

<Uniform RGB>

Prints in black and white so that R, G, and B are uniformly converted to the same gray level by using only brightness as the reference.

<Paper Save>

Specify whether to disable a blank page in print data from being output.

<Off> †
 <On>

 <Menu> ▶ <Function Settings> ▶ <Printer> ▶ <Printer Settings> ▶ <XPS> ▶ <Paper Save> ▶ Select <Off> or <On> ▶ 

<Compressed Image Output>

Specify the operation that is to be performed when the image quality has degraded due to insufficient memory during printing.

<Output> †
 <Display Error>

 <Menu> ▶ <Function Settings> ▶ <Printer> ▶ <Printer Settings> ▶ <XPS> ▶ <Compressed Image Output> ▶ Select <Output> or <Display Error> ▶ 

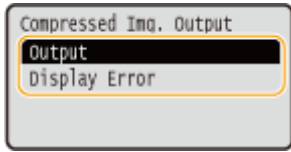

<Output>

Continues printing regardless of how much the image quality has degraded.

<Display Error>

If the image quality has degraded significantly, an error message is displayed, and printing is stopped.

<PDL Selection (Plug and Play)>

Select a page description language so that the machine is detected as a printer that is compatible with that language when it is connected to a computer by using Plug and Play.

<Network> *2

Select a page description language so that the machine is detected as a printer that is compatible with that language when it is detected over the network.



<USB>

Select a page description language so that the machine is detected as a printer that is compatible with that language when it is connected to a computer via USB.



 <Menu> ▶ <Function Settings> ▶ <Printer> ▶ <PDL Selection (Plug and Play)> ▶ Select <Network> or <USB> ▶ Select a page description language ▶ Restart the machine

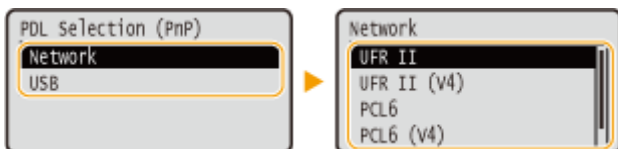

<UFR II>

Detects and connects the machine as a UFR II printer.

<UFR II (V4)>

Detects and connects the machine as a UFR II printer that is compatible with XML Paper Specification (XPS).

<PCL6>

Detects and connects the machine as a PCL6 printer.

<PCL6 (V4)>

Detects and connects the machine as a PCL6 printer.

<PS> *1

Detects and connects the machine as a PS printer.

<Receive>

All the settings related to receiving I-Faxes are listed with descriptions. Default Settings are marked with a dagger (†).

▶<Common Settings>(P. 325)

▶<E-Mail Settings>(P. 325)

<Common Settings>

Specify operations that are to be performed when the amount remaining in the toner cartridges is running low.

<Continue Print. When Amount in Cart. Low>

When I-Faxes are received while the amount remaining in the toner cartridges is running low, they will not be printed. However, if this function is enabled, you can still continue printing even if the amount remaining in the toner cartridges is running low.

<Off> †
<On>



<Menu> ▶ <Function Settings> ▶ <Receive> ▶ <Common Settings> ▶ <Continue Print. When Amount in Cart. Low> ▶ <On> ▶

! IMPORTANT

- When this function is enabled, the print of I-Faxes may be faded or blurry. Received documents will not be stored, so you need to ask the sender to resend the document if it is illegible.

<E-Mail Settings>

Configure settings to print received I-Fax documents.

<Print on Both Sides>

Prints received document on both sides of paper.

<Off> †
<On>



<Menu> ▶ <Function Settings> ▶ <Receive> ▶ <E-Mail Settings> ▶ <Print on Both Sides> ▶ <On> ▶

<RX Print Size>

Specify the paper size to be used for printing.

<A4> †
<LTR>
<LGL>
<FOOLSCAP/FOLIO>
<OFICIO>
<Government-LTR>
<Government-LGL>
<India-LGL>
<AUS-FOOLSCAP>
<Brazil-OFICIO>
<Mexico-OFICIO>



<Menu> ▶ <Function Settings> ▶ <Receive> ▶ <E-Mail Settings> ▶ <RX Print Size> ▶ Select the paper size ▶ 

<Secure Print>

7YX2-05X

Specify whether to enable or disable Secure Print (**▶Printing via Secure Print(P. 144)**). Default settings are marked with a dagger (†).

<Use Secure Print>

<Off>

<On> †

<Restrict Printer Jobs>

<Off> †

<On>

<Secure Print Deletion Time>

10 to 30 † to 240 (min.)

<Management Settings>

7YX2-05Y

Item	Description
▶<User Management>(P. 329)	You can configure the settings for managing users of the machine.
▶<Device Management>(P. 330)	You can manage information about the hardware and operations, as well as various data required when using the machine functions.
▶<Remote UI Settings/Update Firmware>(P. 333)	You can configure the settings related to the Remote UI and software available for the machine.
▶<Data Management>(P. 335)	You can configure settings to utilize data such as machine settings data or perform data initialization.
▶<Security Settings>(P. 337)	You can configure the settings related to the user authentication function, password, and encryption.
<Initialize All Data/Settings>	Restores all data including logs and setting values to their default settings. ▶<Initializing All Data/Settings>(P. 252)

<User Management>

7YX2-060

All the settings related to user management of the machine are listed with descriptions. Default settings are marked with a dagger (†).

▶<System Manager Information Settings>(P. 329)

▶<Department ID Management>(P. 329)

<System Manager Information Settings>

Specify the ID or PIN exclusively for Administrators who have access privileges to <Network> and <Management Settings>. ID is <System Manager ID> and PIN is <System Manager PIN>. You can also register the name of an Administrator. ▶<Setting the System Manager ID and PIN(P. 173)>

<System Manager ID and PIN>

Enter a number for the System Manager ID and PIN.

<System Manager ID>
<System Manager PIN>

<System Manager Name>

Enter alphanumeric characters for the name of an Administrator.

<Department ID Management>

Select whether to use the Department ID Management, a feature that uses IDs as user accounts to specify access privileges and maintain information on how the machine is used. ▶<Setting the Department ID Management(P. 175)>

<Off> †
<On>



<Menu> ▶ <Management Settings> ▶ <User Management> ▶ <Department ID Management> ▶ Select <Off> or <On> ▶

<Device Management>

All the settings related to management of information for the hardware and operations, as well as about management of data required when using the machine functions are listed with descriptions. Default settings are marked with a dagger (†).

- ▶ <Device Information Settings>(P. 330)
- ▶ <Select Country/Region>(P. 330)
- ▶ <Display Job Log>(P. 331)
- ▶ <Displ. Consmbls. Info (RUI/Toner Status)>(P. 331)
- ▶ <Notify to Check Paper Settings>(P. 332)
- ▶ <Canon Genuine Mode>(P. 332)

NOTE

Asterisks (*)

- Settings marked with "*1" cannot be imported or exported.
- Settings marked with "*2" may be unavailable or vary or have different defaults depending on your country or region.

<Device Information Settings>

Enter alphanumeric characters for the name and the installation location to identify the machine.

<Device Name>
<Location>



<Menu> ▶ <Management Settings> ▶ <Device Management> ▶ <Device Information Settings> ▶ Select <Device Name> or <Location> ▶ Enter the device name or location (▶ **Entering Text(P. 97)**) ▶ <Apply> ▶

<Select Country/Region> *1 *2

Specify the country or region where the machine is used. The default setting may vary depending on the setting selected at initial power-on.

<Austria (AT)>	<Netherlands (NL)>
<Belarus (BY)>	<Norway (NO)>
<Belgium (BE)>	<Poland (PL)>
<Czech Republic (CZ)>	<Portugal (PT)>
<Denmark (DK)>	<Russia (RU)>
<Egypt (EG)>	<Saudi Arabia (SA)>
<Finland (FI)>	<Slovenia (SI)>
<France (FR)>	<South Africa (ZA)>
<Germany (DE)>	<Spain (ES)>

<Greece (GR)>	<Sweden (SE)>
<Hungary (HU)>	<Switzerland (CH)>
<Ireland (IE)>	<United Arab Emirates (AE)>
<Italy (IT)>	<Ukraine (UA)>
<Jordan (JO)>	<Great Britain (GB)> †
<Luxembourg (LU)>	<Other>



<Menu> ▶ <Management Settings> ▶ <Device Management> ▶ <Select Country/Region> ▶ Select a country or region ▶

<Display Job Log>

Select whether to display printing logs on the machine display.

<Off>
<On> †



<Menu> ▶ <Management Settings> ▶ <Device Management> ▶ <Display Job Log> ▶ Select <Off> or <On> ▶ Restart the machine

<Displ. Consmbls. Info (RUI/Toner Status)>

Set whether to display a button in the Remote UI or Toner Status for accessing the Web site for purchasing toner cartridges. Also set whether to use Toner Status.

<Displ. Consumables Purchase Button (RUI)>

<Off>
<On> †

<Toner Status Settings>

<Off>
<On> †
<Displ. Consmbls. Purchase Btn.>
<Off>
<On> †



<Menu> ▶ <Management Settings> ▶ <Device Management> ▶ <Displ. Consmbls. Info (RUI/Toner Status)> ▶ Specify the settings ▶

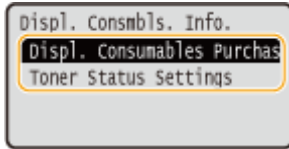

<Displ. Consumables Purchase Button (RUI)>

Select <Off> to prevent a button that accesses sites for purchasing toner cartridges from being displayed in the Remote UI.

<Toner Status Settings>

If you do not want to use Toner Status, select <Off>. To prevent a button that accesses sites for purchasing toner cartridges from being displayed in Toner Status, select <On> and then <Off>.

<Notify to Check Paper Settings>

Specify whether to display a message prompting you to check paper settings when loading the paper drawer into the machine.

<Off>
<On> +





<Menu> ▶ <Management Settings> ▶ <Device Management> ▶ <Notify to Check Paper Settings> ▶ Select <Off> or <On> ▶ Restart the machine

<Canon Genuine Mode>

The mode for when Canon genuine toner cartridges are used.

<Off> +
<On>



<Menu> ▶ <Management Settings> ▶ <Device Management> ▶ <Canon Genuine Mode> ▶ Select <Off> or <On> ▶ 

NOTE

- When necessary, the service representative may change the setting. If this item is not displayed, contact the administrator of the machine.

<Remote UI Settings/Update Firmware>

All the settings related to the software available for the machine are listed with descriptions. Default settings are marked with a dagger (†).

▶<Remote UI Settings>(P. 333)

▶<Update Firmware>(P. 334)

NOTE

Asterisks (*)

- Settings marked with an asterisk (*) cannot be imported or exported.

<Remote UI Settings> *

Configure settings for using the Remote UI. Using the Remote UI allows you to configure machine settings from a Web browser.

<Use Remote UI>

Select whether to use the Remote UI (▶<Disabling Remote UI(P. 225)). When using Remote UI, you can also specify whether to use the TLS encrypted communication (▶<Configuring the Key and Certificate for TLS(P. 195)).

<Off>

<On> †

<Use TLS>

<Off> †

<On>



<Menu> ▶ <Management Settings> ▶ <Remote UI Settings/Update Firmware> ▶ <Remote UI Settings> ▶ <Use Remote UI> ▶ <On> ▶ Select <Off> or <On> ▶ Restart the machine

<Remote UI Access Security Settings>

Specify so that entry of a PIN is required for access to the Remote UI. Set a PIN of up to 7 digits. All users use a common PIN. ▶<Setting a Remote UI PIN(P. 181)

<Off> †

<On>

<Remote UI Access PIN>



<Menu> ▶ <Management Settings> ▶ <Remote UI Settings/Update Firmware> ▶ <Remote UI Settings> ▶ <Remote UI Access Security Settings> ▶ <On> ▶ Enter the PIN ▶ <Apply> ▶ Enter the PIN (Confirm) ▶ <Apply> ▶

<Update Firmware> *

Select how to install the firmware update according to the environment of the machine. **▶ Updating the Firmware(P. 248)**

<Via PC>
<Via Internet>
<Version Information>

<Data Management>

The settings for utilizing the machine settings and for initializing data are listed with descriptions. Default settings are marked with a dagger (†).

- ▶<Import/Export>(P. 335)
- ▶<Enable Product Extended Survey Program>(P. 335)
- ▶<Initialize Key and Certificate>(P. 336)
- ▶<Initialize Menu>(P. 336)

NOTE

Asterisks (*)

- Settings marked with an asterisk (*) cannot be imported or exported.

<Import/Export> *

You can import and export various settings of the machine by using a USB memory device. For more information about the available USB memory devices and how to insert/remove the USB memory device, see ▶<Using a USB Memory Device>(P. 133) .

<Import>
<Export>

Import



<Menu> ▶ <Management Settings> ▶ <Data Management> ▶ <Import/Export> ▶ <Import>
▶ <Yes> ▶ Enter the password ▶ <Apply>

Export



<Menu> ▶ <Management Settings> ▶ <Data Management> ▶ <Import/Export> ▶ <Export>
▶ Enter the password ▶ <Apply> ▶ Enter the password (Confirm) ▶ <Apply>

NOTE

When import is executed

- The machine automatically restarts after the import process has finished.

<Enable Product Extended Survey Program>

Enable or disable the Product Extended Survey Program (a program for the machine usage survey).

<Off>
<On> †



<Menu> ▶ <Management Settings> ▶ <Data Management> ▶ <Enable Product Extended Survey Program> ▶ Select <Off> or <On> ▶ Restart the machine

<Initialize Key and Certificate> *

Select to restore [Key and Certificate Settings] and [CA Certificate Settings] to the factory defaults. **▶ Initializing Key and Certificate(P. 251)**

<Initialize Menu> *

Select to restore the settings listed below to the factory defaults. You can restore all the settings listed below at once, or you can restore individual settings separately. **▶ Initializing Menu(P. 251)**

<Preferences>
<Adjustment/Maintenance>
<Function Settings>
<Management Settings>
<Initialize All>

<Security Settings>

All the settings related to the authentication function and encryption are listed with descriptions. Default Settings are marked with a dagger (†).

- ▶<Authentication/Password Settings>(P. 337)
- ▶<Encryption Settings>(P. 337)
- ▶<Verify System at Startup>(P. 338)

<Authentication/Password Settings>

You can reinforce the security of the authentication function.

<Authentication Function Settings>

Configure the security functions for user authentication.

<Lockout Settings>

When a user has failed user authentication, specify whether to disable the user from temporarily logging in to the machine (lockout). When <On> is selected, specify how many consecutive times failures are permitted before lockout is activated and also the time required before a user can log in again after lockout.

<Enable Lockout>

<Off> †

<On>

<Lockout Threshold>

1 † to 10 (time(s))

<Lockout Period>

1 † to 60 (min.)



<Menu> ▶ <Management Settings> ▶ <Security Settings> ▶ <Authentication/Password Settings> ▶ <Authentication Function Settings> ▶ <Lockout Settings> ▶ <Enable Lockout> ▶ <On> ▶ Specify each setting item ▶ Restart the machine

! IMPORTANT:

- This option is not applied to login using the department ID.

<Encryption Settings>

Configure a setting for disabling a weak encryption or the key and certification using a weak encryption.

<Prohibit Use of Weak Encryption>

<Off> †

<On>

<Prohibit Key/Cert. with Weak Encryption>

<Off> †
<On>



<Menu> ▶ <Management Settings> ▶ <Security Settings> ▶ <Encryption Settings> ▶ <Prohibit Use of Weak Encryption> ▶ <On> ▶ <Prohibit Key/Cert. with Weak Encryption> ▶ Select <Off> or <On> ▶ Restart the machine

<Verify System at Startup>

When the machine starts, verification is performed to determine that the system has not been tampered. If tampering is detected, the machine enters a state to wait for firmware update. In this case, perform a firmware update operation from a computer. **▶ Updating the Firmware(P. 248)**

<Off> †
<On>



<Menu> ▶ <Management Settings> ▶ <Security Settings> ▶ <Verify System at Startup> ▶ <On> ▶ **OK** ▶ Restart the machine automatically

! IMPORTANT

- If nothing is displayed even after a while, system recovery may be impossible. In this case, contact your dealer or service representative.

Maintenance

Maintenance	340
Regular Cleaning	342
Cleaning the Exterior	343
Cleaning the Fixing Assembly	344
Replacing the Toner Cartridge	345
Checking the Remaining Amount of Consumables	352
Relocating the Machine	353
Adjusting Image Quality	355
Adjusting Print Density	356
Adjusting Print Position	357
Viewing the Counter Value	359
Printing Reports and Lists	360
Consumables	363

Maintenance

7YX2-065

This chapter describes upkeep of the machine, including how to clean the machine and adjustment of print quality.

! IMPORTANT

Maintenance and Inspections

- The minimum holding period for performance parts for repairs and toner cartridges is seven (7) years after production of the machine model is discontinued.
- If a problem occurs during operation, see "Troubleshooting (FAQ)" on the online manual website. If the problem still cannot be resolved or you think the machine needs to be checked, contact your dealer or service representative.

Installation

- If you find the machine's operation to be noisy in some operating modes or due to your surroundings, we recommend setting up the machine in a separate location from your office.
- Water droplets (condensation) may form inside the machine if the room where the machine is installed is heated rapidly, or if the machine is moved from a cool, dry location to a warm, humid location. Using the machine under these conditions may result in problems such as paper jams, poor print quality, or faults. Let the machine adjust to the ambient temperature and humidity for at least two hours before use.
- Machines with storage devices such as hard disks may not operate properly when used at high altitudes (3,000 meters above sea level or higher).

■ Basic Cleaning



▶ Regular Cleaning(P. 342)

■ Replacing Consumables

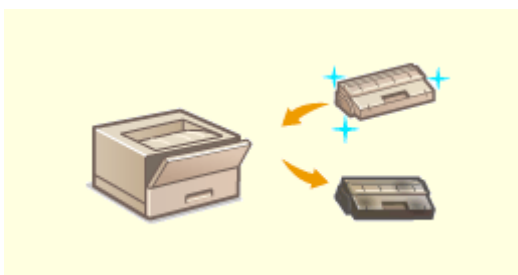

▶ Replacing the Toner Cartridge(P. 345)



▶ Checking the Remaining Amount of Consumables(P. 352)



▶ Consumables(P. 363)

■ Adjusting and Managing the Machine

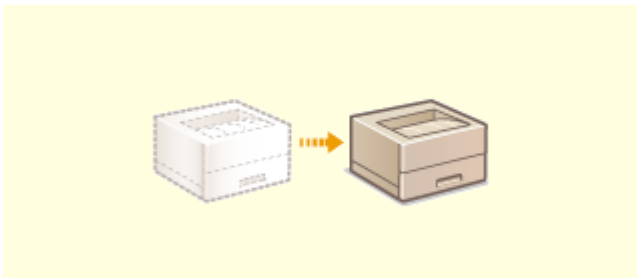

▶ Relocating the Machine(P. 353)



▶ Adjusting Image Quality(P. 355)

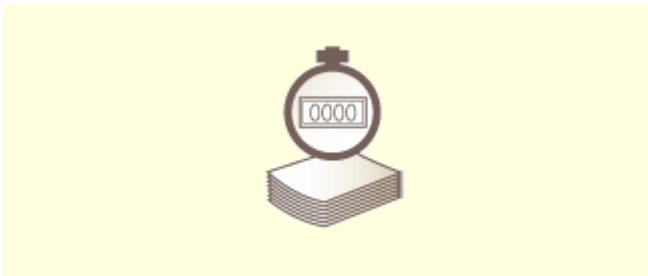

▶ Viewing the Counter Value(P. 359)



▶ Printing Reports and Lists(P. 360)

Regular Cleaning

7YX2-066

Regularly clean the machine to prevent deterioration in printing quality and to ensure that you use it safely and easily.

Where to Clean

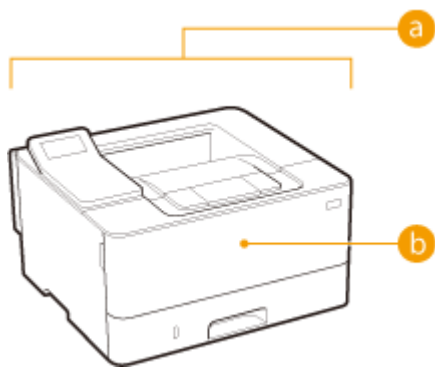

a Exterior of the machine and ventilation slots

▶ **Cleaning the Exterior(P. 343)**

b Internal fixing assembly

▶ **Cleaning the Fixing Assembly(P. 344)**

Cleaning the Exterior

7YX2-067

Regularly wipe the exterior of the machine, especially around the ventilation slots, to keep the machine in good condition.

1 Turn OFF the machine, and unplug the power cord from the AC power outlet.

- When you turn OFF the machine, data that is waiting to be printed is deleted.

2 Clean the exterior of the machine and the ventilation slots.

- Use a soft, well-wrung-out cloth dampened with water or a mild detergent diluted with water.
- To locate the ventilation slots, see [▶Front Side\(P. 74\)](#) .

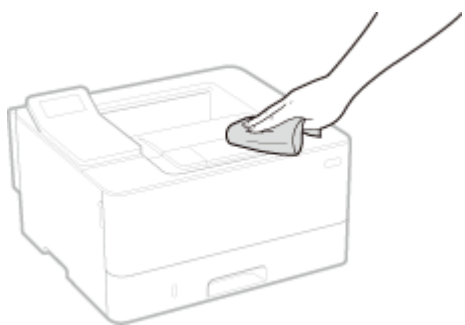

3 Wait for the exterior of machine to dry completely.

4 Reconnect the power cord and turn ON the machine.



Cleaning the Fixing Assembly



7YX2-068

Dirt may adhere to the fixing assembly inside the machine and cause black streaks to appear on printouts. To clean the fixing assembly, perform the following procedure. Note that you cannot clean the fixing assembly when the machine has documents waiting to be printed. To clean the fixing assembly, you need plain A4 or Letter size paper. Set the paper in the paper drawer or multi-purpose tray before performing the following procedure.  **Loading Paper(P. 101)**

NOTE

- Cleaning consumes the toner cartridge. Make sure that there is sufficient toner cartridge remaining beforehand.  **Checking the Remaining Amount of Consumables(P. 352)**

- 1** Select <Menu> in the Home screen.  **Home Screen(P. 91)**
- 2** Select <Adjustment/Maintenance>  <Maintenance>.
- 3** Select <Clean Fixing Assembly>.
- 4** Check that the size and type of paper displayed on the screen is loaded in the machine.
- 5** Press .

 Cleaning starts. When a message appears notifying that cleaning is complete, press  to return to the Home screen.

Replacing the Toner Cartridge

7YX2-069

A warning message appears in the display when the amount remaining in the toner cartridge is low or when printing is no longer possible because of toner depletion. Note that the print quality may suffer if you continue printing without resolving this issue. You can check the amount remaining in the toner cartridges on the display (**▶Checking the Remaining Amount of Consumables(P. 352)**).

- ▶**When a Message Appear(P. 345)**
- ▶**When Printouts are Poor in Quality(P. 347)**
- ▶**Before Replacing the Toner Cartridge(P. 347)**
- ▶**Procedure for Replacing the Toner Cartridge(P. 348)**

When a Message Appear

The message that is displayed depends on the amount remaining in the toner cartridges. Depending on which message is displayed, you will need to make sure that you have a replacement toner cartridge ready or replace the toner cartridge.

- ▶**Before Replacing the Toner Cartridge(P. 347)**
- ▶**Procedure for Replacing the Toner Cartridge(P. 348)**
- ▶**Consumables(P. 363)**

<Prepare cartridge.>

This message notifies you that a toner cartridge needs to be replaced soon. Make sure that you have a replacement toner cartridge ready. Replace the toner cartridge if you see this message before you start to print a large job.

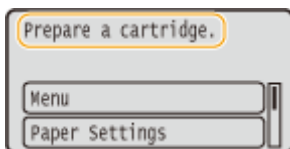

NOTE

When a message is displayed

- When printing, you can continue printing the original.
- If a message is displayed while an I-Fax document is being received, the machine does not perform printing so that unclear print is avoided. To continue printing even if the amount remaining in toner cartridge is running low, set <Continue Print. When Amount in Cart. Low> to <On>. **▶<Continue Print. When Amount in Cart. Low>(P. 325)**

Specify when a message is displayed

- You can set any value as the percentage of the amount remaining in the toner cartridge that triggers a message. **▶<Displ. Timing for Cartridge Prep. Notif.>(P. 258)**

<Low Cartridge Level>

This message notifies you that a toner cartridge needs to be replaced soon. Make sure that you have a replacement toner cartridge ready. Replace the toner cartridge if you see this message before you start to print a large job. This appears when <Action When Warning> is set to <Stop Printing> (**▶<Action When Warning>(P. 259)**).

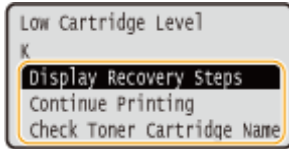

<Display Recovery Steps>

Displays the procedure for replacing a toner cartridge. Follow the on-screen instructions to replace the toner cartridge.

<Continue Printing>

You can end a printing stoppage state and continue printing.

<Check Toner Cartridge Name>

You can check the toner cartridge name.

NOTE:

- If a message is displayed while an I-Fax document is being received, the machine does not perform printing so that unclear print is avoided. Instead, the received data is stored in memory. To continue printing even if the amount remaining in toner cartridge is running low, set <Continue Print. When Amount in Cart. Low> to <On>. <Continue Print. When Amount in Cart. Low>(P. 325)

NOTE

Specify when a message is displayed

- You can set any value as the percentage of the amount remaining in the toner cartridge that triggers a message. <Displ. Timing for Cartridge Prep. Notif.>(P. 258)

<Cart. end of lifetime. Rplcmt. recommended.>

This message notifies you that a toner cartridge has reached the end of its lifetime. It is recommended that you replace the cartridge with a new one. You can continue printing, but the print quality cannot be guaranteed.

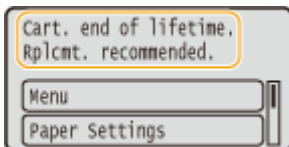

<Cannot print. A non-Canon or counterfeit cartridge may be in use.>

This message notifies you that the machine may not print in optimum quality. It is recommended that you replace this cartridge with a new one.



IMPORTANT

- When this message is displayed, you cannot continue printing. <Canon Genuine Mode>(P. 332)

When Printouts are Poor in Quality

If your printouts begin to show any of the following features, one of your toner cartridges is consumed. Replace the nearly empty toner cartridge even if no message is displayed.

- **Before Replacing the Toner Cartridge(P. 347)**
- **Procedure for Replacing the Toner Cartridge(P. 348)**

Streaks Appear/Printing is Uneven



Partially faded



Uneven density



White Spots Appear



Toner smudges and splatters appear



Blank space of originals becomes grayish in printouts



Before Replacing the Toner Cartridge

Perform the following before replacing the toner cartridge. The message may no longer appear, or print quality may be improved.

1 Open the front cover.

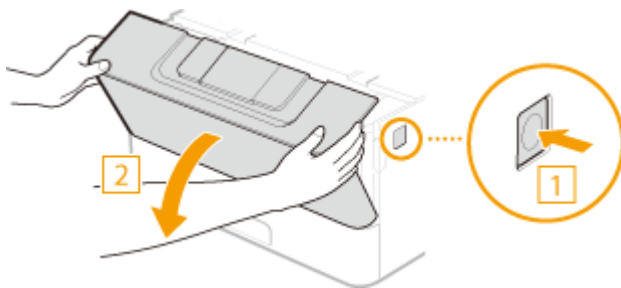

2 Remove the toner cartridge.

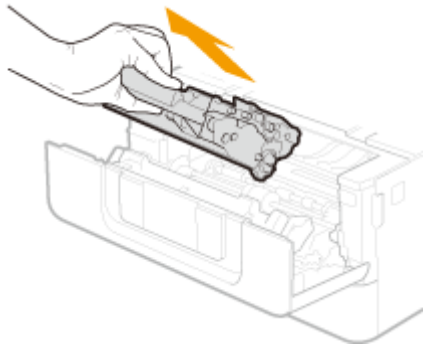

3 Shake the toner cartridge 5 or 6 times as shown below to evenly distribute the toner inside the cartridge.

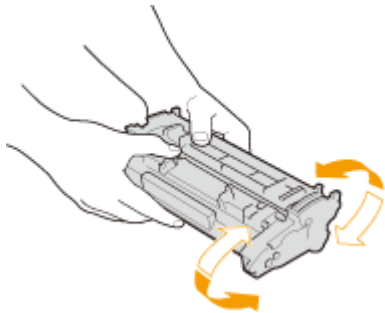

4 Install the toner cartridge.

- Fully push it in until it cannot go any further.

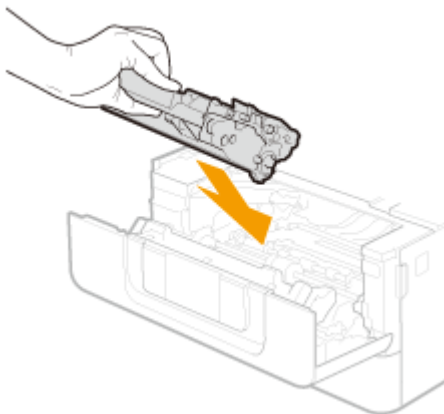

5 Close the front cover.

Procedure for Replacing the Toner Cartridge

CAUTION

Do not touch the contacts (a) inside the machine

- Doing so may result in a fault.

CAUTION

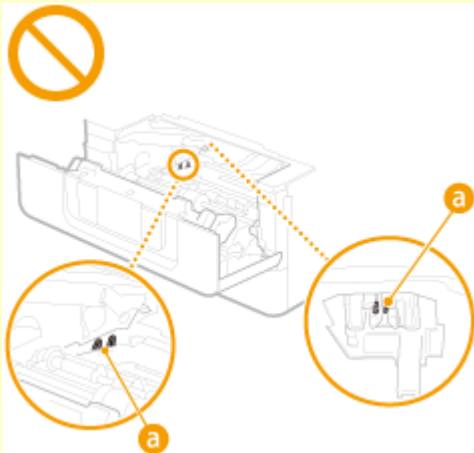

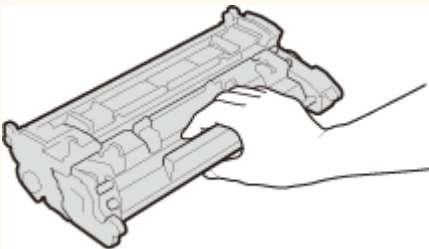

IMPORTANT

- Be sure to hold the toner cartridge using the handle.

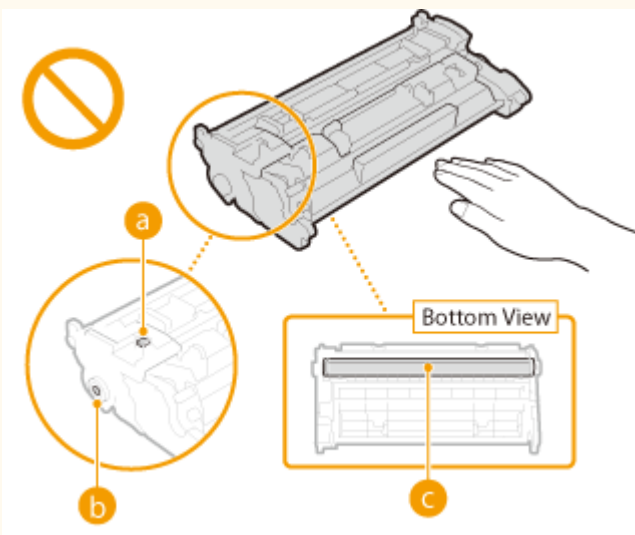

- Do not touch the toner cartridge memory (a) or the electrical contacts (b). To avoid scratching the surface of the drum inside the machine or exposing it to light, do not open the drum protective shutter (c).



Read the precautions in "Important Safety Instructions" provided with this product before replacing the toner cartridges.  **Manuals and Their Contents(P. 391)**

1 Open the front cover.



2 Remove the toner cartridge.

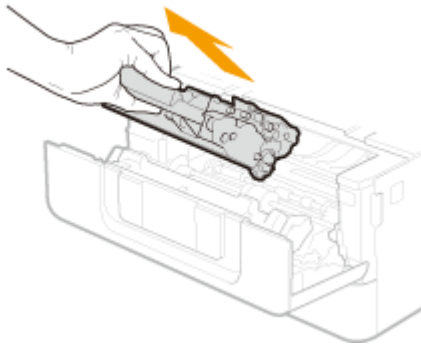

3 Remove the replacement toner cartridge from the protective case.

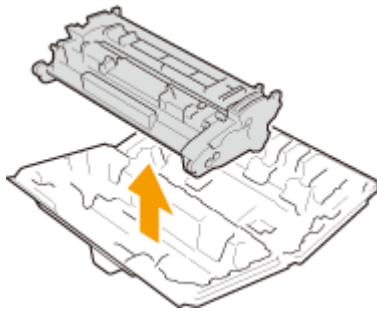

4 Shake the toner cartridge 5 or 6 times as shown below to evenly distribute the toner inside the cartridge.

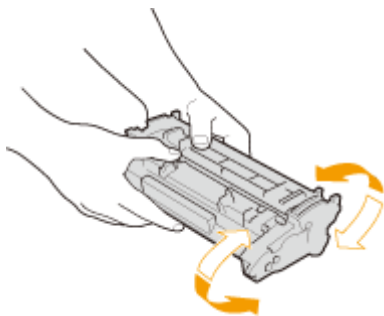

5 Install the toner cartridge.

- Fully push it in until it cannot go any further.

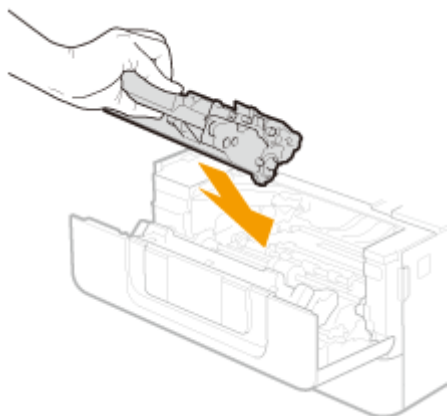

6 Close the front cover.

LINKS

▶ [Consumables\(P. 363\)](#)

Checking the Remaining Amount of Consumables

7YX2-06A

Use the procedure below to check the amount remaining in the toner cartridges. It is particularly important to check whether you need to have a new toner cartridge ready before starting a large print job.



 ▶ <Device Status> ▶ <Cartridge Level> ▶ Checking the amount remaining in the toner cartridges ▶ 

NOTE

- The displayed amount remaining in a toner cartridge can be used only as a guide and may differ from the actual amount.

LINKS

- ▶ [Replacing the Toner Cartridge\(P. 345\)](#)
- ▶ [Consumables\(P. 363\)](#)

Relocating the Machine

7YX2-06C

The machine is heavy. Make sure to follow the procedure below when moving the machine to avoid injury.

! IMPORTANT

- If the machine is to be transported for relocation, removals, etc., take the following steps to prevent damage and faults during transportation:
 - Remove the toner cartridges.
 - Securely pack the machine in the original packaging (box) and packing materials.

1 Turn OFF the machine and computer.

- When you turn OFF the machine, data that is waiting to be printed is deleted.

2 Disconnect the cables and cord from the machine in numerical order as in the illustration below.

- Whether the cables with "*" are connected depends on your environment.

- 1 Power plug
- 2 Power cord
- 3 USB keyboard*
- 4 USB cable*
- 5 LAN cable*

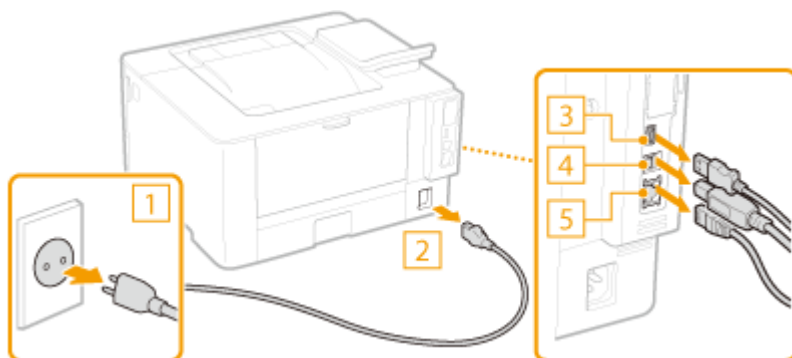

3 When transporting the machine across a long distance, remove the toner cartridges. ▶ Procedure for Replacing the Toner Cartridge (P. 348)

4 Pull out the paper drawer.

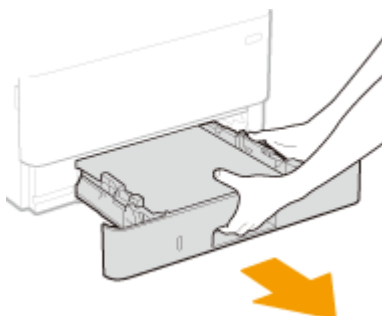

! IMPORTANT:

- Make sure to hold the paper drawer with both hands, and pull it out gently. Otherwise, you may damage the paper drawer by dropping it, if it slides out too easily.

5 Close all the open covers and multi-purpose tray, and move the machine to a new location.

- The machine is heavy (▶Main Unit(P. 377)). Do not try hard to carry the machine.
- Position yourself toward the front side of the machine and hold the lift handles, then lift up the machine. If you have attached the optional cassette feeding module, leave the cassette feeding module on the floor and move it after moving the main unit of the machine.

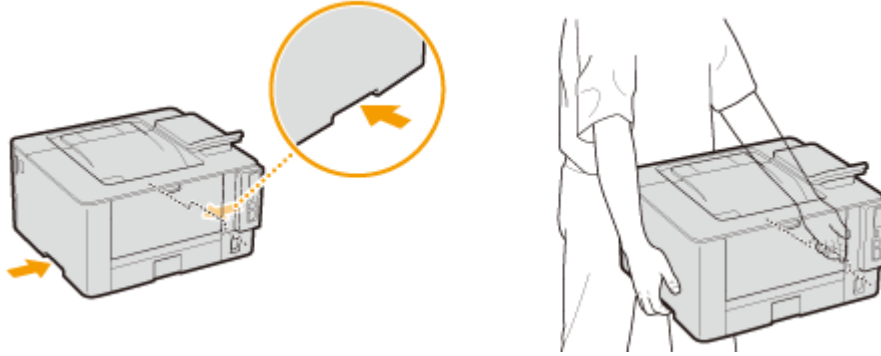

6 Carefully place the machine at the new installation site.

- For information about how to install the machine after relocating it, see "Setup Guide." ▶Manuals and Their Contents(P. 391)

Adjusting Image Quality

7YX2-06E

If the print results are not satisfactory such as low image quality, poor reproducibility, or skewed printouts, try the adjustments below.

■ Density Adjustment

When the print results are too dark or too light, you can adjust the density. ▶ **Adjusting Print Density(P. 356)**

■ Adjust Print Position

You can adjust the print position when the printed image is skewed or part of the image is outside the print range. ▶ **Adjusting Print Position(P. 357)**

Adjusting Print Density

7YX2-06F

When the print results are too dark or too light, you can adjust the density.

- 1** Select <Menu> in the Home screen. ▶ Home Screen(P. 91)
- 2** Select <Adjustment/Maintenance> ▶ <Adjust Image Quality>.
- 3** Select <Printer Density>.
- 4** Adjust the density.

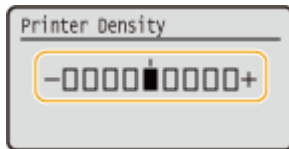

- 5** Press **OK**.

Adjusting Print Position

7YX2-06H

If a document is printed off-center or out of the printable range, adjust the print position. You can adjust the print position for each paper source. You can adjust the print position in the range -5.0 mm to +5.0 mm in increments of 0.1 mm.

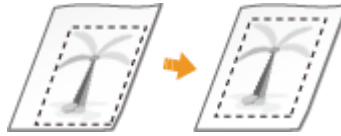

Checking the Direction and Distance to Adjust

When you adjust the print position, specify the direction using "+" and "-" and the distance using "mm." For <Adjust Vertically (Front Side)>/<Adjust Vertically (Back Side)>, specify a value with a "+" sign to shift the print position in the up-to-down direction. For <Adjust Horizontally (Front Side)>/<Adjust Horizontally (Back Side)>, specify a value with a "+" sign to shift the print position in the left-to-right direction. To shift in the reverse direction, specify a value with a "-" sign.

<Adjust Vertically (Front Side)>/<Adjust Vertically (Back Side)>



<Adjust Horizontally (Front Side)>/<Adjust Horizontally (Back Side)>

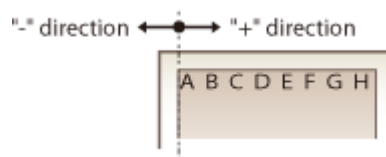

1 Select <Menu> in the Home screen. Home Screen(P. 91)

2 Select <Adjustment/Maintenance> <Adjust Image Quality>.

3 Select <Adjust Print Position>.

4 Select the paper source.

- When the optional cassette feeding module is installed, its paper drawer is also displayed.

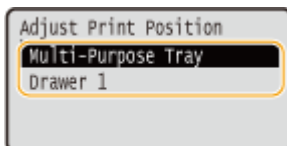

5 Select the combination of adjustment direction and printing side.

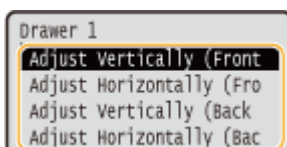

6 Set an adjustment value.

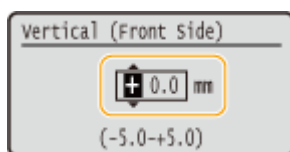

7 Press **OK**.

Adjusting the Print Position for All Print Jobs

- You can use <Function Settings> in the setting menu of the operation panel to adjust the print position for all print jobs, irrespective of the paper source. The print position can be adjusted in 0.5 mm increments between -50.0 mm and +50.0 mm. ▶<Offset Short Edge/Offset Long Edge>(P. 305)

Viewing the Counter Value

7YX2-06J

You can check the total number of pages printed by the machine. The number of printouts includes printouts of the list as well as printouts of data from computers.

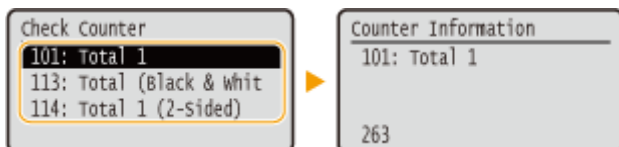
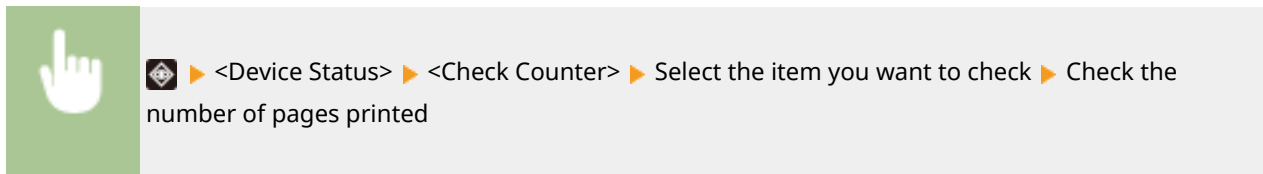

<101: Total 1>

Displays the total number of pages printed.

<113: Total (Black & White/Small)>

Displays the total number of pages printed in black and white.

<114: Total 1 (2-Sided)>

Displays the total number of pages printed in two-sided printing mode.

Printing Reports and Lists

You can print reports and lists to check information such as the total volume of printouts for each <Department ID> and machine settings.

- ▶ **Configuring the Print Settings for Reports and Lists(P. 360)**
- ▶ **Printing a Report on the Total Volume of Printouts by Department ID(P. 360)**
- ▶ **Printing Lists of Settings(P. 360)**
- ▶ **Printing Reports and Lists on the Usage Status of the Machine(P. 361)**

Configuring the Print Settings for Reports and Lists

You can perform 2-sided printing of reports and lists.



<Menu> ▶ <Output Reports> ▶ <Report Settings> ▶ <Default Settings for Report Output> ▶ <2-Sided Printing> ▶ <On> ▶

Printing a Report on the Total Volume of Printouts by Department ID

Department ID Management Report

When Department ID Management is enabled, you can check the total volume of printouts for each <Department ID> by printing a Department ID Management Report. By checking the printout totals, you can better manage your paper and toner cartridge supplies.



<Menu> ▶ <Output Reports> ▶ <Print List> ▶ <Department ID Management Report> ▶ Check that the size and type of paper displayed on the screen is loaded in the machine ▶ ▶ <Yes> ▶

Printing Lists of Settings

You can print information and settings registered in the machine as a list.

User Data List/System Manager Data List

You can check the list of the settings (▶ **Setting Menu List(P. 254)**) as well as the content that has been registered in the machine by printing a User Data List or a System Manager Data List. Both lists include the firmware version and the paper size and type registered in the machine.



<Menu> ▶ <Output Reports> ▶ <Print List> ▶ Select <User Data List> or <System Manager Data List> ▶ Check that the size and type of paper displayed on the screen is loaded in the machine ▶ **OK** ▶ <Yes> ▶

NOTE

- The User Data List does not include certain settings such as Network Settings and Management Settings. To check all the settings items, print the System Manager Data List.

IPSec Policy List

You can check the list of policy names and the IPSec settings registered in the machine by printing an IPSec Policy List.



<Menu> ▶ <Output Reports> ▶ <Print List> ▶ <IPSec Policy List> ▶ Check that the size and type of paper displayed on the screen is loaded in the machine ▶ **OK** ▶ <Yes> ▶

Printing Reports and Lists on the Usage Status of the Machine

You can print the machine status report, the usage log of toner cartridges, and the list of fonts available in PCL or PS mode.

Eco Report

You can check the monthly total volume of printouts and the power consumption with a report. This report includes tips that are useful for saving paper and power consumption based on the usage status.



<Menu> ▶ <Output Reports> ▶ <Print List> ▶ <Eco Report> ▶ Check that the size and type of paper displayed on the screen is loaded in the machine ▶ **OK** ▶ <Yes> ▶

NOTE

- The amount of power consumption may vary depending on the environment and conditions where the machine is used.

Consumables Status Report

You can check the consumables status installed in the machine with a report.



<Menu> ▶ <Output Reports> ▶ <Print List> ▶ <Consumables Status Report> ▶ Check that the size and type of paper displayed on the screen is loaded in the machine ▶ **OK** ▶ <Yes> ▶

PCL Font List

You can check the list of fonts available in PCL mode with a report.



<Menu> ▶ <Output Reports> ▶ <Print List> ▶ <PCL Font List> ▶ Check that the size and type of paper displayed on the screen is loaded in the machine ▶ **OK** ▶ <Yes> ▶

PS Font List

You can check the list of fonts available in PS mode with a report.



<Menu> ▶ <Output Reports> ▶ <Print List> ▶ <PS Font List> ▶ Check that the size and type of paper displayed on the screen is loaded in the machine ▶ **OK** ▶ <Yes> ▶

Cartridge Log Report

You can check the usage logs of toner cartridges with a report.



<Menu> ▶ <Output Reports> ▶ <Print List> ▶ <Cartridge Log Report> ▶ Check that the size and type of paper displayed on the screen is loaded in the machine ▶ **OK** ▶ <Yes> ▶

Consumables

7YX2-06L

The following is a guide to the estimated replacement time for the consumables used in this machine. Observe safety and health precautions when storing and handling consumables. For optimum print quality, using Canon genuine Toner, Cartridge and Parts is recommended.



NOTE

- To handle and store consumables, observe precautions in "Important Safety Instructions" provided with this product.
- Depending on the installation environment, printing paper size, or original type, you may need to replace consumables before the end of the estimated lifetime.
- Specifying an auto shutdown time shorter than the default setting (4 hours) may shorten the life of the toner cartridges.

■ Toner Cartridges

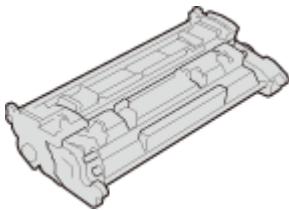

Supplied Toner Cartridge

The average yield* of the toner cartridge that comes with the machine are shown below.

- 1,500 sheets

Replacement Toner Cartridges

For optimum print quality, using Canon genuine toner cartridges is recommended.

Canon Genuine Toner Cartridge	Average yield * of toner cartridge
Canon Cartridge 057	3,100 sheets
Canon Cartridge 057 H	10,000 sheets

* The average yield is based on "ISO/IEC 19752" (the global standard related to "Method for the determination of toner cartridge yield for monochromatic electrophotographic printers and multi-function devices that contain printer components" issued by ISO [International Organization for Standardization]) when printing A4 size paper with the default print density setting.



Store toner cartridges as described below

Storing toner cartridges in an improper location or environment may cause problems such as data loss.

- Store toner cartridges in the following conditions:

 **CAUTION**

- Storage temperature range: 0 °C to 35 °C
- Storage humidity range: 35 % to 85 % RH (relative humidity, condensation-free)*

*Even within the approved storage humidity range, water droplets (condensation) may develop inside the toner cartridge if the temperatures inside and outside the toner cartridge differ. Condensation will adversely affect the print quality.

- Store unopened until immediately prior to use.
- Do not store toner cartridges upright or upside down.
- Do not store toner cartridges in the following locations:
 - Locations exposed to open flames
 - Locations exposed to direct sunlight or bright light for five minutes or more
 - Locations exposed to excessively salty air
 - Locations heavily exposed to corrosive gases (e.g. aerosol sprays or ammonia)
 - Very hot and/or humid locations
 - Locations subject to dramatic changes in temperature and humidity likely to cause condensation
 - Very dusty locations
 - Locations within the reach of children
- Store the packaging material safely for future use. It will be needed for situations such as storing the machine with the toner cartridges removed.
- Canon reserves the right to reposition, reshape, add or remove packaging material without notice.

 **IMPORTANT****Be careful of counterfeit toner cartridges**

- Please be aware that there are counterfeit Canon toner cartridges in the marketplace. Use of counterfeit toner cartridge may result in poor print quality or machine performance. Canon is not responsible for any malfunction, accident or damage caused by the use of counterfeit toner cartridge. For more information, see global.canon/ctc.

NOTE

- When replacing toner cartridges, see  **Replacing the Toner Cartridge(P. 345)** .

Troubleshooting (FAQ)

Troubleshooting (FAQ) 366

Troubleshooting (FAQ)

7YX2-06R

When a problem occurs, check this chapter to find out solutions before contacting Canon.

Appendix

Appendix	368
Third Party Software	370
Feature Highlights	371
Going Green and Saving Money	372
Improving Efficiency	373
So Much More	374
Specifications	376
Main Unit	377
Available Paper	379
Cassette Feeding Module-AH	382
Printer Functions	383
Management Functions	385
System Environment	387
Network Environment	388
Options	389
Optional Equipment	390
Manuals and Their Contents	391
Using User's Guide	392
Screen Layout of User's Guide	393
Viewing User's Guide	396
Basic Windows Operations	398
Notice	405

Appendix

7YX2-06S

This chapter contains technical specifications of this machine, instructions on how to use the User's Guide, disclaimers, copyright information, and other important information for customers.

■ Machine Specifications

See the following section(s) when you want to check the specifications of the main unit and optional equipment, network environment, print function, and so on.



▶ Specifications(P. 376)

■ Using Optional Equipment

See the following section(s) when you want to check what options are available to use this machine more conveniently and more effectively.

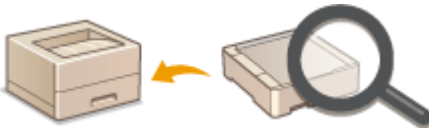

▶ Options(P. 389)

■ Referencing the Manual of This Machine

See the first of the following sections when you want to be sure of the kinds of the manuals describing the functions of the machine and how to operate the machine. When you want to know how to read and use the User's Guide (this manual), see the second section.



▶ Manuals and Their Contents(P. 391)

▶ Using User's Guide(P. 392)

■ Others

See the following section(s) when you want to get useful information, and check the disclaimers and copyright information.



- ▶ **Third Party Software(P. 370)**
- ▶ **Feature Highlights(P. 371)**
- ▶ **Basic Windows Operations(P. 398)**
- ▶ **Notice(P. 405)**

Third Party Software

7YX2-06U

For information related to third-party software, click the following icon(s).

Third-Party Software Included in This Manual



Feature Highlights

7YX2-06W

This section describes tips for leveraging the features of the machine by category. You can make use of the features according to your intended purposes and operating environment.

- ▶ **Going Green and Saving Money(P. 372)**
- ▶ **Improving Efficiency(P. 373)**
- ▶ **So Much More(P. 374)**

Going Green and Saving Money

7YX2-06X



There are lots of ways to cut back on paper, toner, power, and expenses.



2-Sided Printing

You can use the 2-sided printing function to print data from your computer and print received I-Fax documents. Because you'll only be using half the paper you would otherwise, you can cut your paper costs in half. To save even more, combine 2-sided printing with N on 1 printing of multiple pages on one sheet of paper. You can print up to 32 pages on a single sheet, which is both economical and environmentally friendly.

▶ **Printing from a Computer(P. 136)**

▶ **<Receive>(P. 325)** ▶ <E-Mail Settings> ▶ <Print on Both Sides>



Sleep Mode

For saving energy and money, a sleep mode that powers down a machine when nobody is using it has become an essential feature. This machine will enter sleep mode automatically, and can also be put to sleep whenever you want. Press  once to put the machine to sleep. Press it again to instantly wake the machine back into action.

▶ **Entering Sleep Mode(P. 131)**

Improving Efficiency

7YX2-06Y



Here are some simple operations that can make complicated tasks more efficient.

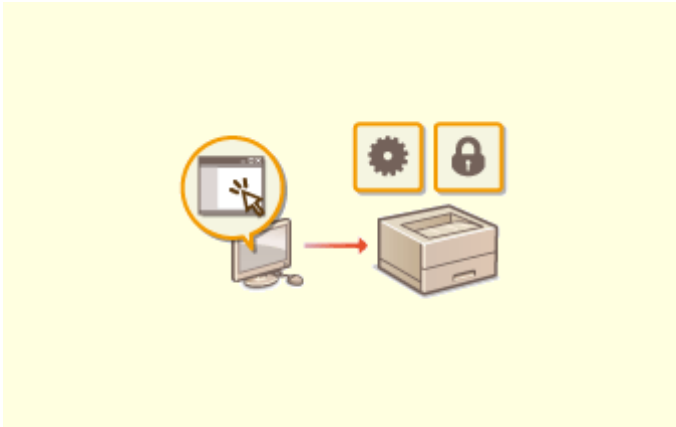

Remote Management with Remote UI

Remote UI lets you manage a lot from your computer, all without having to go over to the machine. Configure settings and keep an eye on the machine's status with an intuitive, easy-to-understand Web browser interface that you'll master immediately. Save your time and energy for things other than taking care of the machine.

▶ **Managing the Machine from a Computer (Remote UI) (P. 227)**

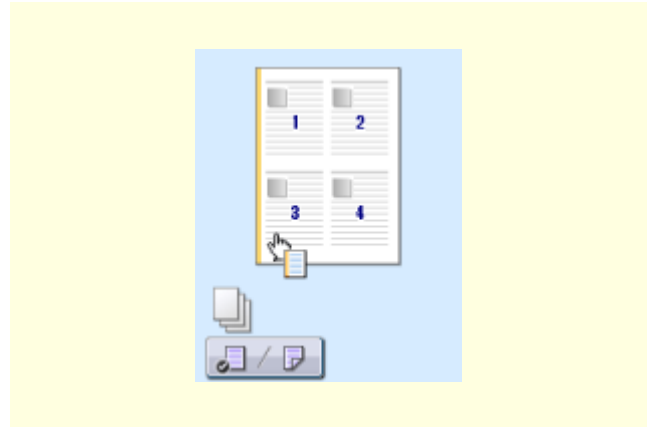

Make Print Settings Quickly with Intuitive Operation

You can easily specify the page layout as well as binding position, switching between 1-sided and 2-sided printing, etc. intuitively on the preview image in the printer driver. The simple click-operation allows you to conveniently make settings while viewing how settings are applied.

▶ **Printing from a Computer(P. 136)**

So Much More

7YX2-070



There are a variety of features for whatever you need to do - at home, in the office, or even on the road.

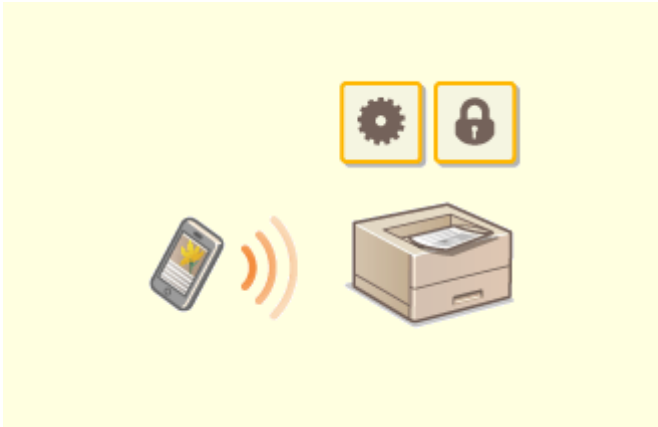

Using a smartphone/tablet

At times such as when you want to quickly print out a proposal you completed on a tablet while travelling to a business destination, Canon PRINT Business comes in handy. Even in environments without a wireless LAN router, you can connect to the machine with a mobile device wirelessly and directly.

PCless, quick, and easy! An even broader range of possibilities for work/play with functionality made for this age of speed.

▶ **Linking with Mobile Devices(P. 151)**



Keep Your Printouts Private

Normally, when you print something from your computer, it comes out of the printer right away. However, if you have sensitive documents, this may not be what you want. Just use secure printing and no one will be able to print your documents without entering your password on the machine's operation panel. Don't let your confidential documents lie exposed on the tray for everyone to see.

▶ **Printing a Document Secured by a PIN (Secure Print)(P. 143)**

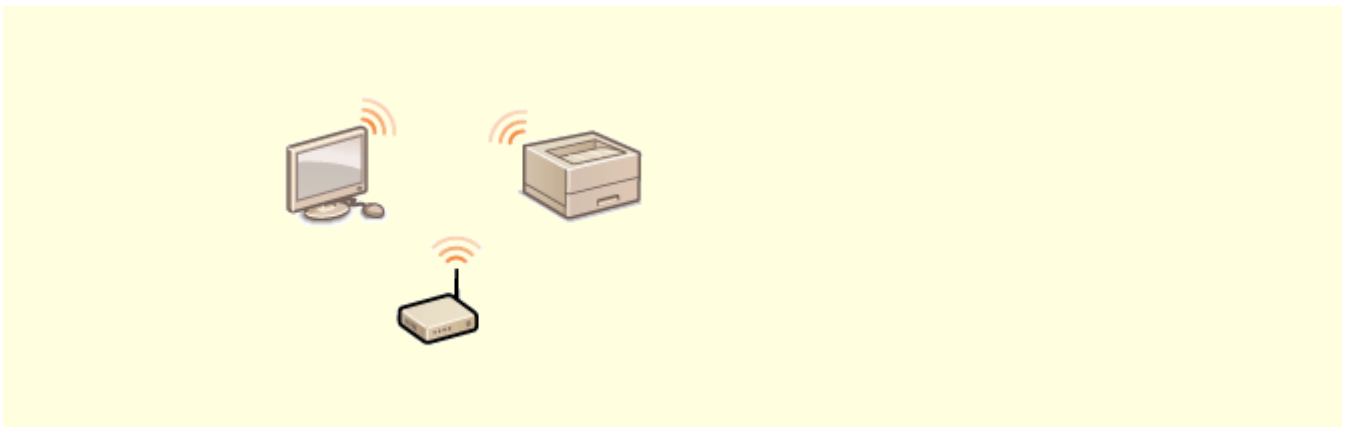

Go Wireless

No cables, easy installation, simple maintenance. If you've got a WPS wireless LAN router, bypass the settings process altogether and be ready to go before you know it. Enjoy the kind of clutter-free and easy to use document system that you can only get from wireless. Compatible with IEEE 802.11b/g/n for stress-free wireless, and also supports WEP and WPA/WPA2-PSK (TKIP/AES-CCMP) for tighter security.

▶ **Connecting to a Wireless LAN(P. 15)**

Specifications

7YX2-071

Specifications are subject to change without notice for product improvement or future release.

■ Machine Specifications

- ▶ **Main Unit(P. 377)**
- ▶ **Available Paper(P. 379)**

■ Specifications of Optional Equipment

- ▶ **Cassette Feeding Module-AH(P. 382)**

■ Functional Specifications

- ▶ **Printer Functions(P. 383)**
- ▶ **Management Functions(P. 385)**

■ Environment To Use the Machine

- ▶ **System Environment(P. 387)**
- ▶ **Network Environment(P. 388)**

Main Unit

7YX2-072

NOTE

- For information on paper sizes and types for each paper source, see " [▶ Available Paper\(P. 379\)](#) . "

Type	Desktop
Color Supported	Black and White
Resolution for Writing	600 dpi x 600 dpi
Number of Tones	256
Acceptable Paper Stock	<p>Paper Sizes</p> <ul style="list-style-type: none"> Max: 216.0 mm x 355.6 mm Min (Paper Drawer): 105.0 mm x 148.0 mm Min (Multi-Purpose Tray): 76.2 mm x 127.0 mm <p>Paper Weight</p> <ul style="list-style-type: none"> Paper Drawer: 60 g/m² to 120 g/m² Multi-Purpose Tray: 60 g/m² to 163 g/m²
Paper Type	▶ Available Paper(P. 379)
Warm-Up Time ^{*1}	<p>After Powering ON</p> <p>14.0 seconds or less</p> <p>Returning from the Sleep Mode</p> <p>4.0 seconds or less</p>
First Print Time (A4)	Approx. 5.4 seconds
Print Speed ^{*2} (A4)	<p>LBP236dw</p> <p>38.0 sheets/minute</p> <p>LBP233dw</p> <p>33.0 sheets/minute</p>
Paper Feeding System/Capacity ^{*3}	<p>Paper Drawer</p> <p>250 sheets (80 g/m²)/250 sheets (64 g/m²) x 1</p> <p>Multi-Purpose Tray</p> <p>100 sheets (80 g/m²)/100 sheets (64 g/m²) x 1</p>

Paper Output System/Capacity *3	Output Tray 150 sheets (68 g/m ²)
Power Source	AC 220 V - 240 V, 3.1 A, 50 Hz/60 Hz
Power Consumption *1	Maximum Power Consumption 1,330 W or less During Sleep Mode <ul style="list-style-type: none"> • Approx. 0.9 W (USB connection) • Approx. 0.9 W (wired LAN connection) • Approx. 0.9 W (wireless LAN connection) With the Main Power Turned OFF 0.1 W or less
Dimensions (W x D x H)	401 mm x 373 mm x 250 mm
Weight	Main Unit *4 Approx. 8.8 kg
Maximum Occupancy Space (W x D x H)	401 mm x 874 mm x 381 mm *Provide a space of 100 mm or more around the machine.
Memory Capacity	RAM: 1 GB
Environmental Conditions	<ul style="list-style-type: none"> • Temperature: 10 °C to 30 °C • Humidity: 20 % to 80 % RH (no condensation)

*1 May vary depending on the environment and conditions under which the machine is being used.

*2 Print speed is measured based on internal testing using A4 size paper printed with 100% print ratio to original on one-sided paper. Internal testing involved continuously printing the same one page of content on plain paper. Print speed may vary depending on paper type, paper size or paper feeding direction. The device may automatically pause or slow down in order to adjust printer condition such as controlling temperature of a certain unit or limiting impact to image quality during continuous printing.

*3 May vary depending on the installation environment and paper to use.

*4 The toner cartridge is not included.

Available Paper

7YX2-073

The paper types that can be used with this machine are shown in the following table.

■ Supported Paper Sizes

✓ : Available — : Unavailable

Paper Sizes	Paper Drawer ^{*1}	Multi-Purpose Tray	Automatic 2-Sided Printing ^{*2}
A4 ^{*3*4}	✓	✓	✓
B5	✓	✓	—
A5 ^{*5}	✓	✓	—
A6	✓	✓	—
Legal (LGL) ^{*3}	✓	✓	✓
Letter (LTR) ^{*3*4}	✓	✓	✓
Statement (STMT)	✓	✓	—
Executive (EXEC)	✓	✓	—
Oficio ^{*3}	✓	✓	✓
Oficio (Brazil) ^{*3}	✓	✓	✓
Oficio (Mexico) ^{*3}	✓	✓	✓
Letter (Government) ^{*3}	✓	✓	—
Legal (Government) ^{*3}	✓	✓	—
Foolscap/Folio ^{*3}	✓	✓	✓
Foolscap (Australia) ^{*3}	✓	✓	—
Legal (India) ^{*3}	✓	✓	✓
3x5inch	—	✓	—

Paper Sizes	Paper Drawer ^{*1}	Multi-Purpose Tray	Automatic 2-Sided Printing ^{*2}
Envelope No.10 (COM10)	—	✓	—
Envelope Monarch	—	✓	—
Envelope C5	—	✓	—
Envelope DL	—	✓	—
Custom Paper Size	✓ ^{*6}	✓ ^{*7}	✓ ^{*8}

^{*1}Includes the optional Cassette Feeding Module-AH.

^{*2}Automatic 2-sided printing is available without replacing paper.

^{*3}Allows you to print received I-Fax documents.

^{*4}Allows you to print reports or lists.

^{*5}Landscape or portrait orientation is available.

^{*6}The custom size ranging from 105.0 mm x 148.0 mm to 216.0 mm x 355.6 mm is available.

^{*7}The custom size ranging from 76.2 mm x 127.0 mm to 216.0 mm x 355.6 mm is available.

^{*8}The custom size ranging from 210.0 mm x 279.4 mm to 216.0 mm x 355.6 mm is available.

■ Supported Paper Types

Chlorine-free paper can be used with this machine.

✓ : Available — : Unavailable

Paper Type		Paper Drawer ^{*1}	Multi-Purpose Tray	Automatic 2-Sided Printing ^{*2}
Plain 1 ^{*3*4}	61 g/m ² to 74 g/m ²	✓	✓	✓
Plain 2 ^{*3*4}	75 g/m ² to 89 g/m ²	✓	✓	✓
Plain 3 ^{*4}	90 g/m ² to 105 g/m ²	✓	✓	✓
Recycled 1 ^{*3*4}	61 g/m ² to 74 g/m ²	✓	✓	✓
Recycled 2 ^{*3*4}	75 g/m ² to 89 g/m ²	✓	✓	✓
Color ^{*3*4}	61 g/m ² to 74 g/m ²	✓	✓	✓
Heavy 1	106 g/m ² to 120 g/m ²	✓	✓	✓
Heavy 2	121 g/m ² to 149 g/m ²	—	✓	—

Appendix

Paper Type		Paper Drawer ^{*1}	Multi-Purpose Tray	Automatic 2-Sided Printing ^{*2}
Heavy 3	150 g/m ² to 163 g/m ²	—	✓	—
Thin 1 ^{*3}	60 g/m ²	✓	✓	✓
Bond 1	60 g/m ² to 74 g/m ²	✓	✓	✓
Bond 2	75 g/m ² to 104 g/m ²	✓	✓	✓
Bond 3	105 g/m ² to 120 g/m ²	✓	✓	✓
Labels		—	✓	—
Envelope 1		—	✓	—
Envelope 2 ^{*5}		—	✓	—

^{*1}Includes the optional Cassette Feeding Module-AH.

^{*2}Automatic 2-sided printing is available without replacing paper.

^{*3}Allows you to print received I-Fax documents.

^{*4}Allows you to print reports or lists.

^{*5}If printing cannot be performed properly with <Envelope 1> selected, change the selection to <Envelope 2>.

Cassette Feeding Module-AH

7YX2-074

Paper Sizes	<ul style="list-style-type: none"> ● Max: 216.0 mm x 355.6 mm ● Min: 105.0 mm x 148.0 mm
Paper Weight	60 g/m ² to 120 g/m ²
Paper Drawers Capacity *	550 sheets (80 g/m ²)/640 sheets (64 g/m ²) x 1
Dimensions (W x D x H)	399 mm x 373 mm x 156 mm
Weight	Approx. 3.8 kg

*May vary depending on the installation environment and paper to use.

Printer Functions

7YX2-075

■ UFR II Printer Function

Type	Internal
Print Size	▶ Available Paper(P. 379)
Print Speed	Same as "Print Speed" in "Main Unit" ▶ Main Unit(P. 377)
Resolution	Data Processing 1200 dpi x 1200 dpi, 600 dpi x 600 dpi
Page Description Language (PDL)	UFR II
Protocol Supported	TCP/IP: LPD, Port9100, IPP, IPPS, WSD
Resident Fonts	None
Interface	USB USB2.0 High-Speed Wired LAN 10Base-T, 100Base-TX, 1000Base-T (IEEE 802.3 compliant) Wireless LAN IEEE 802.11b, IEEE 802.11g, IEEE 802.11n

■ PS Printer Function*

Type	Internal
Print Size	▶ Available Paper(P. 379)
Print Speed	Same as "Print Speed" in "Main Unit" ▶ Main Unit(P. 377)
Resolution	Data Processing 1200 dpi x 1200 dpi, 600 dpi x 600 dpi
Page Description Language (PDL)	Adobe®PostScript®3™
Protocol Supported	TCP/IP: LPD, Port9100, IPP, IPPS, WSD

Resident Fonts	136 Roman
Interface	USB USB2.0 High-Speed Wired LAN 10Base-T, 100Base-TX, 1000Base-T (IEEE 802.3 compliant) Wireless LAN IEEE 802.11b, IEEE 802.11g, IEEE 802.11n

*The PS printer function is available with the LBP236dw.

■ PCL Printer Function

Type	Internal
Print Size	▶ Available Paper(P. 379)
Print Speed	Same as "Print Speed" in "Main Unit" ▶ Main Unit(P. 377)
Resolution	Data Processing 1200 dpi x 1200 dpi, 600 dpi x 600 dpi
Page Description Language (PDL)	PCL6, PCL5
Protocol Supported	TCP/IP: LPD, Port9100, IPP, IPPS, WSD
Resident Fonts	PCL fonts: 45 Roman, 10 Bitmap fonts
Interface	USB USB2.0 High-Speed Wired LAN 10Base-T, 100Base-TX, 1000Base-T (IEEE 802.3 compliant) Wireless LAN IEEE 802.11b, IEEE 802.11g, IEEE 802.11n

Management Functions

7YX2-076

■ Firewall Settings

- Up to 16 IP addresses (or ranges of IP addresses) can be specified for both IPv4 and IPv6.
- Up to 32 MAC addresses can be specified.

■ IPsec

- IPsec that is supported by the machine conforms to RFC2401, RFC2402, RFC2406, and RFC4305.

Operating system	<ul style="list-style-type: none"> • Windows 8.1 • Windows 10 	
Connection mode	Transport mode	
Key exchange protocol	IKEv1 (main mode)	
	Authentication method	<ul style="list-style-type: none"> • Pre-shared key • Digital signature
	Hash algorithm (and key length)	<ul style="list-style-type: none"> • HMAC-SHA1-96 • HMAC-SHA2 (256 bits or 384 bits)
	Encryption algorithm (and key length)	<ul style="list-style-type: none"> • 3DES-CBC • AES-CBC (128 bits, 192 bits, or 256 bits)
	Key exchange algorithm/group (and key length)	Diffie-Hellman (DH) <ul style="list-style-type: none"> • Group 14 (2048 bits) • ECDH-P256 (256 bits) • ECDH-P384 (384 bits)
ESP	Hash algorithm	HMAC-SHA1-96
	Encryption algorithm (and key length)	<ul style="list-style-type: none"> • 3DES-CBC • AES-CBC (128 bits, 192 bits, or 256 bits)
	Hash algorithm/encryption algorithm (and key length)	AES-GCM (128 bits, 192 bits, or 256 bits)
AH	Hash algorithm	HMAC-SHA1-96

NOTE

- IPsec supports communication to a unicast address (or a single device).

■ Registration of Keys and Certificates

- If you install a key or CA certificate from a computer, make sure that they meet the following requirements:

Format	<ul style="list-style-type: none"> Key: PKCS#12^{*1} CA certificate: X.509 DER/PEM
File extension	<ul style="list-style-type: none"> Key: ".p12" or ".pfx" CA certificate: ".cer" or ".pem"
Public key algorithm (and key length)	<ul style="list-style-type: none"> RSA (512 bits, 1024 bits, 2048 bits, 4096 bits) DSA (1024 bits, 2048 bits, 3072 bits) ECDSA (P256, P384, P521)
Certificate signature algorithm	<ul style="list-style-type: none"> RSA: SHA-1, SHA-256, SHA-384^{*2}, SHA-512^{*2}, MD2, MD5 DSA: SHA-1 ECDSA: SHA-1, SHA-256, SHA-384, SHA-512
Certificate thumbprint algorithm	SHA1

^{*1}Requirements for the certificate contained in a key are pursuant to CA certificates.

^{*2}RSA-SHA-384 and RSA-SHA-512 are available only when the RSA key length is 1024 bits or more.

NOTE

- The machine does not support use of a certificate revocation list (CRL).

■ Definition of "Weak Encryption"

When <Prohibit Use of Weak Encryption> is set to <On>, the use of the following algorithms is prohibited.

Hash	MD4, MD5, SHA-1
HMAC	HMAC-MD5
Common key cryptosystem	RC2, RC4, DES
Public key cryptosystem	RSA encryption (512 bits/1024 bits), RSA signature (512 bits/1024 bits), DSA (512 bits/1024 bits), DH (512 bits/1024 bits)

NOTE

- Even when <Prohibit Key/Cert. with Weak Encryption> is set to <On>, the hash algorithm SHA-1, which is used for signing a root certificate, can be used.

System Environment

7YX2-077

System Requirements for the Remote UI *1	Windows <ul style="list-style-type: none"> • Internet Explorer 11 • Microsoft Edge • Google Chrome macOS <ul style="list-style-type: none"> • Safari 11 or later • Google Chrome
I-Fax Receiving Server Software	<ul style="list-style-type: none"> • Microsoft Exchange Server 2010 • Microsoft Exchange Server 2013 • Microsoft Exchange Server 2016 • Microsoft Exchange Server 2019 • Lotus Domino R7.0 • Qpopper 4.0.19
System Requirements for the User's Guide	Windows <ul style="list-style-type: none"> • Internet Explorer 9 and later • Microsoft Edge • Firefox • Firefox ESR • Chrome*2 macOS <ul style="list-style-type: none"> • Safari • Firefox • Chrome*2 Linux <ul style="list-style-type: none"> • Firefox iOS <ul style="list-style-type: none"> • Safari*2 Android <ul style="list-style-type: none"> • Chrome*2

*1 Before changing the settings of the machine, set your Web browser to enable all cookies and use JavaScript.

*2 Only when browsing the manual on the Internet.

Network Environment

7YX2-078

■ Common Specifications

Protocol Supported	TCP/IP <ul style="list-style-type: none"> ● Frame type: Ethernet II ● Print applications: LPD, Raw, IPP, IPPS, WSD, Mopria, AirPrint, Windows10 Mobile Print
---------------------------	---

■ Wired LAN Specifications

Interface	10BASE-T, 100BASE-TX, 1000BASE-T (RJ-45)
------------------	--

■ Wireless LAN Specifications

Standard	IEEE 802.11b, IEEE 802.11g, IEEE 802.11n
Transmission Scheme	<ul style="list-style-type: none"> ● IEEE 802.11b (Modulation system: DS-SS) ● IEEE 802.11g (Modulation system: OFDM method) ● IEEE 802.11n (Modulation system: OFDM method)
Communication Mode	<ul style="list-style-type: none"> ● Infrastructure Mode ● Access Point Mode
Security (encryption method)	Infrastructure Mode <ul style="list-style-type: none"> ● 128 (104)/64 (40) bit WEP ● WPA-PSK (TKIP/AES-CCMP) ● WPA2-PSK (TKIP/AES-CCMP) Access Point Mode WPA2-PSK (AES-CCMP)
Connection Method	WPS (Wi-Fi Protected Setup), Manual setup

Options

7YX2-079

Installing options on the machine enables you to use more features.

■ Knowing What Types of Options are Available

▶ Optional Equipment(P. 390)

■ Looking for Optional Equipment by Purpose

Adding a Paper Drawer

▶ Cassette Feeding Module-AH(P. 390)

Optional Equipment

7YX2-07A

The functionality of the machine can be fully utilized by using the optional equipment described below.

Cassette Feeding Module-AH

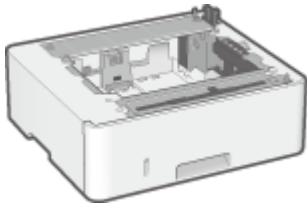

Installing this cassette feeding module enables you to load paper of a different size than that of paper loaded in the standard paper drawer. This surely reduces the time and labor for paper replacement.





Installation Method

See "Setup Guide." [▶ Manuals and Their Contents\(P. 391\)](#)

Manuals and Their Contents

7YX2-07C

The manuals listed below are included with the machine. Refer to them as necessary.

Important Safety Instructions		<p>The content described in this manual is for the prevention of damage to property and injury to users of the machine and others.</p> 
Setup Guide		<p>This manual outlines the initial settings on the machine required when the machine is turned on for the first time; and describes how to install the software and driver.</p> 
User's Guide (This Manual)		<p>This manual describes all the functions of the machine. You can browse information by category or enter a keyword to search for pages on a specific topic. ▶Using User's Guide(P. 392)</p>

For the manuals with  , please click [here](#) .

Using User's Guide

7YX2-07E

The User's Guide is a manual that can be viewed on your computer or mobile device and it describes all of the functions of the machine. You can search from your intended use or enter a keyword to quickly find the page you are looking for. The section describes the screen layout of the User's Guide and how to read the Guide. You can specify how the appearance of the User's Guide looks.

■ Screen Layout of User's Guide

This section describes the screens configuring the User's Guide and how to use the on-screen buttons. [▶Screen Layout of User's Guide\(P. 393\)](#)

■ Viewing User's Guide

This section describes the meaning of the marks used in the User's Guide, how the keys on the operation panel and the buttons on the computer display are represented, and other matters that help you understand the information contained in the User's Guide. [▶Viewing User's Guide\(P. 396\)](#)

■ Specifying How the Appearance of the User's Guide Looks

You can change the character size used in the User's Guide, and switch the screen layout to fit to the device you use to view the User's Guide.

How to Find the Topic You Are Looking for

Search the contents

- You can find the page you are looking for by selecting the topic from the "Contents" on the left side of the screen.

Search by keyword

- Perform a search by entering a keyword, such as "envelope" or "toner cartridge," and the pages containing the keyword are displayed. You can find the page you are looking for from those results. You can also enter phrases such as "connecting to a network." The keyword search also supports the AND Boolean to search for multiple keywords. For the organization of the search screen and how to operate the search screen, see [▶Search\(P. 394\)](#) .

Screen Layout of User's Guide

7YX2-07F

The User's Guide is divided into different screens, and the content of each screen varies.

Top Page

Appears when User's Guide is started.

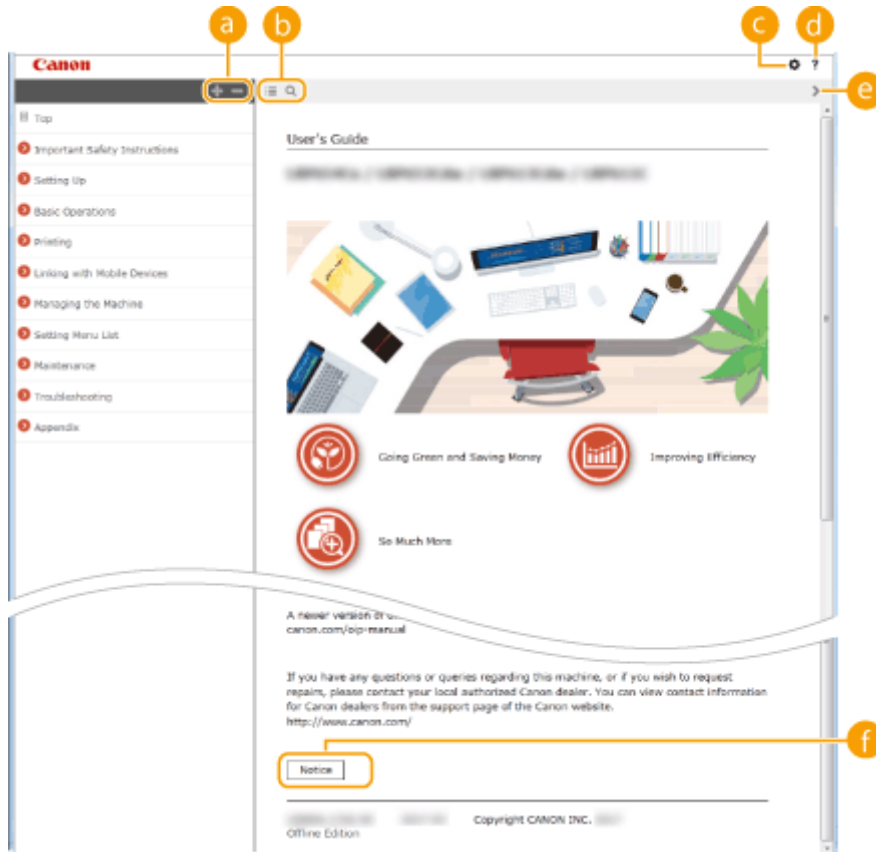

Click to also display all of the sections under the chapters. Click to return to the previous display.



Click to toggle the display between the contents and search. When the table of contents is displayed, each click on switches between hiding and showing the display. When the search display is shown, each click on switches between hiding and showing the display.



Click to set parameters to determine how the User's Guide is displayed, such as character size or layout.



Click to display information on how to view the User's Guide, how to perform a search, and other information.



Click to display the previous or following topic.



Click to view important information you should know when using the machine.

Topic Page

Contains information about how to configure and use the machine.

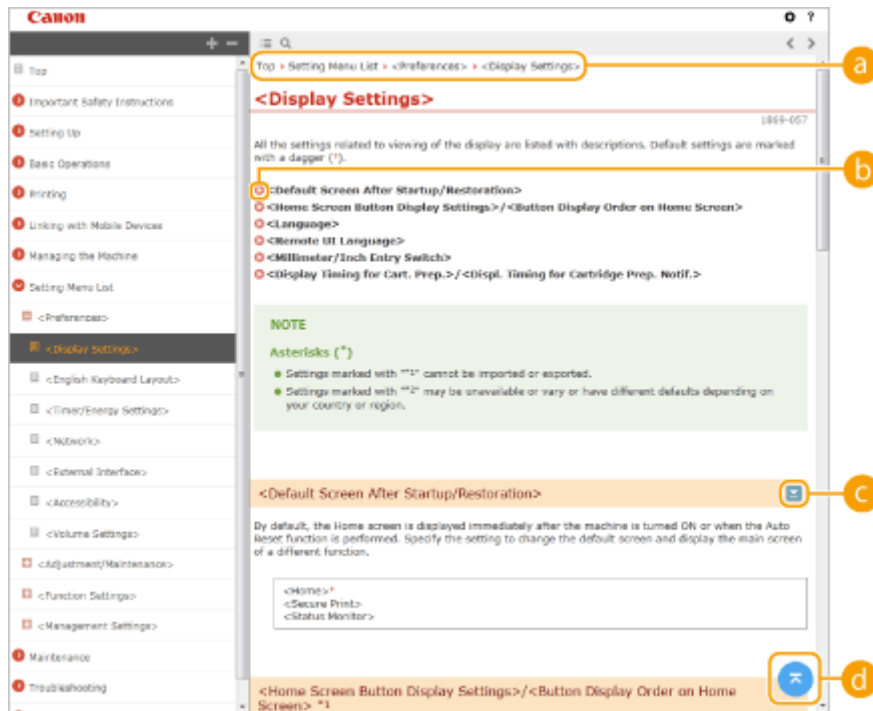

a Navigation

See what chapter topic you are currently viewing.



Click to jump to the corresponding page. To return to the previous page, click "Back" on your Web browser.



Click  to display the hidden detailed descriptions. Click  to close the detailed descriptions.



Click to return to the page top.

Search

Click  to display the search window. Contains a text box to perform a search by keyword and find the page you are looking for.

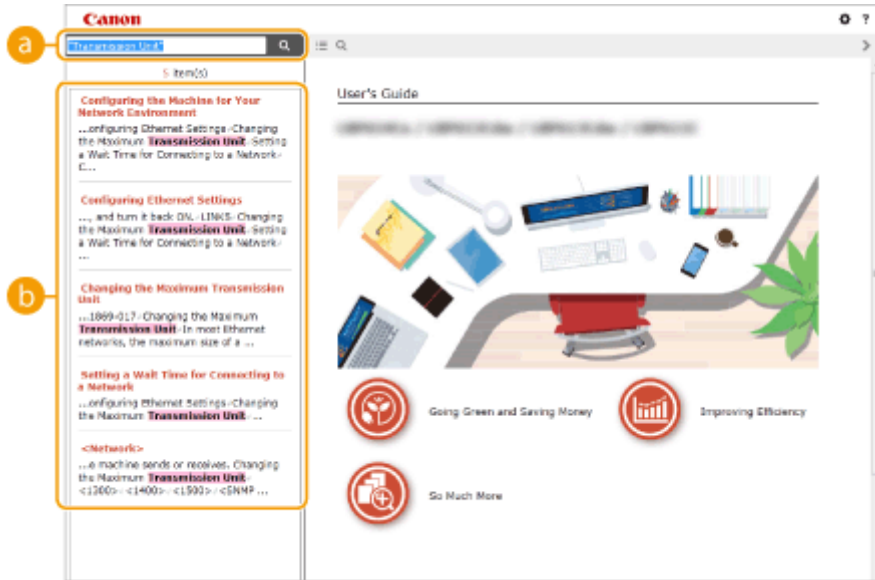

a [Enter keyword(s) here]

Enter a keyword or keywords and click  to display the search results. You can search for pages containing all the keywords by separating the keywords by a space (blank). Also you can only search for pages containing an exact phrase by enclosing the keywords in double quotation marks.

b Search result

Displays the search results of the pages that contain the specified keywords. From the results, locate the page you are looking for and click the topic title of the page.

NOTE:

- The specified keyword(s) are shown in bold in the search results.

Viewing User's Guide

7YX2-07H

This section describes the marks, buttons, screens, and other items used in the User's Guide. The warnings and cautions are also given in the "Important Safety Instructions" included with the machine. See also these instructions.

Marks

Cautions regarding safety, restrictions and cautions regarding the handling of the machine, useful tips, and other information are indicated using the marks below.



Indicates a warning concerning operations that may lead to death or injury to persons if not performed correctly. To use the machine safely, always pay attention to these warnings.



Indicates a caution concerning operations that may lead to injury to persons if not performed correctly. To use the machine safely, always pay attention to these cautions.



Indicates an operation that must not be performed. Read these items carefully, and make sure not to perform the described operations.



Indicates operational requirements and restrictions. Be sure to read these items carefully to operate the machine correctly, and avoid damage to the machine or property.

NOTE



Indicates a clarification of an operation, or contains additional explanations for a procedure.

TIPS



Indicates useful functions or tips for using the machine.

Keys and Buttons Used in this Manual

Keys on the operation panel and buttons on the computer display appear in the following notation:

Type	Example
Keys on the operation panel	 
Settings displayed on the operation panel	<Timer/Energy Settings> <Paper jammed.>
Buttons and other text interfaces displayed on the computer display	[Preferences]



▲, ▼, and  on the operation panel are used to select the target item in settings, but their description is omitted in the User's Guide. The operation for selecting <XXXXX> using ▲ or ▼ and pressing  is represented as shown below in the User's Guide.

- 1 Select <XXXXX>.

Computer Screens Used in This Manual

Unless otherwise noted, displays used in the User's Guide are those for the LBP236dw. Depending on the model or operating system you are using, the appearance of the displays used in this manual may slightly differ from the actual displays. Also, the appearance of drivers and software may differ depending on their version.

Illustrations Used in This Manual

Unless otherwise noted, illustrations used in the User's Guide are those for the LBP236dw. The illustrations of the toner cartridge are those for the Canon Cartridge 057.

Basic Windows Operations

7YX2-07K

- ▶ **Displaying the Printer Folder**(P. 398)
- ▶ **Enabling [Network discovery]**(P. 398)
- ▶ **Displaying Shared Printers in the Print Server**(P. 399)
- ▶ **Printing a Test Page in Windows**(P. 400)
- ▶ **Checking the Bit Architecture**(P. 400)
- ▶ **Checking the Printer Port**(P. 401)
- ▶ **Checking Bidirectional Communication**(P. 402)
- ▶ **Checking the SSID to Which Your Computer is Connected**(P. 403)
- ▶ **When Printing from the Windows Store App**(P. 404)

NOTE

- Depending on the computer that you use, the operation may differ.

■ Displaying the Printer Folder

Windows Vista

[Start] ▶ select [Control Panel] ▶ [Printer].

Windows 7/Server 2008 R2

[Start] ▶ select [Devices and Printers].

Windows 8/Server 2012

Right-click the lower-left corner of the screen ▶ select [Control Panel] ▶ [View devices and printers].

Windows 8.1/Server 2012 R2

Right-click [Start] ▶ select [Control Panel] ▶ [View devices and printers].

Windows 10

[

Windows Server 2008

[Start] ▶ select [Control Panel] ▶ double-click [Printers].

Windows Server 2016

Right-click [

■ Enabling [Network discovery]

Enable [Network discovery] to view the computers on your network.

Windows Vista

[Start] ▶ select [Control Panel] ▶ [View network status and tasks] ▶ select [Turn on network discovery] under [Network discovery].

Windows 7/Server 2008 R2

[Start] ▶ select [Control Panel] ▶ [View network status and tasks] ▶ [Change advanced sharing settings] ▶ select [Turn on network discovery] under [Network discovery].

Windows 8/Server 2012

Right-click the lower-left corner of the screen ▶ select [Control Panel] ▶ [View network status and tasks] ▶ [Change advanced sharing settings] ▶ select [Turn on network discovery] under [Network discovery].

Windows 8.1/Server 2012 R2

Right-click [Start] ► select [Control Panel] ► [View network status and tasks] ► [Change advanced sharing settings] ► select [Turn on network discovery] under [Network discovery].

Windows 10

[

Windows Server 2008

[Start] ► select [Control Panel] ► double-click [Network and Sharing Center] ► select [Turn on network discovery] under [Network discovery].

Windows Server 2016

Right-click [

■ Displaying Shared Printers in the Print Server

1 Open Windows Explorer.

Windows Vista/7/Server 2008

[Start] ► select [All Programs] or [Programs] ► [Accessories] ► [Windows Explorer].

Windows 8/Server 2012

Right-click the lower-left corner of the screen ► select [File Explorer].

Windows 8.1/Server 2012 R2

Right-click [Start] ► select [File Explorer].

Windows 10/Server 2016

Right-click [

2 Select the printer server in [Network] or [My Network Places].

- To view computers on the network, you may need to turn on network discovery or search the network for computers.

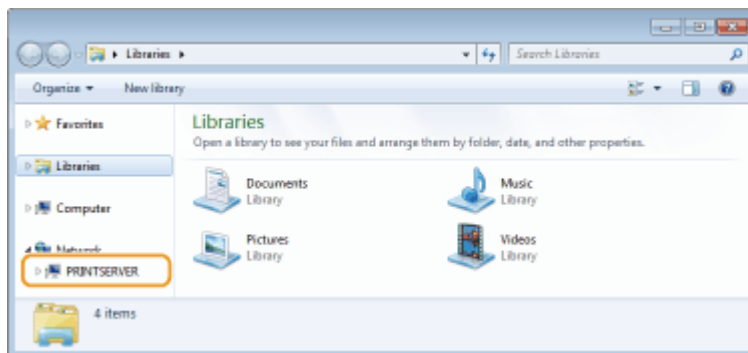

⇒ Shared printers are displayed.

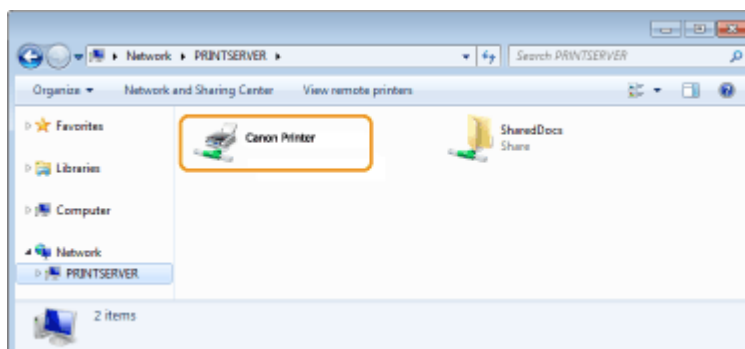

■ Printing a Test Page in Windows

You can check whether the printer driver is operational by printing a test page in Windows.

- 1 Load A4 size paper in the paper drawer. ▶ Loading Paper in the Paper Drawer(P. 103)
- 2 Open the printer folder. ▶ Displaying the Printer Folder(P. 398)
- 3 Right-click the printer driver icon for this machine, and click [Printer properties] or [Properties].

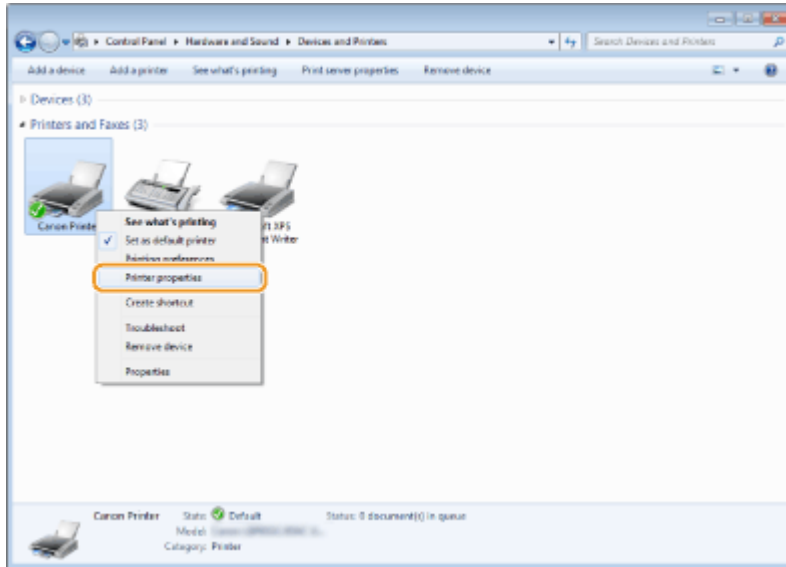

- 4 Click [Print Test Page] in [General] tab.

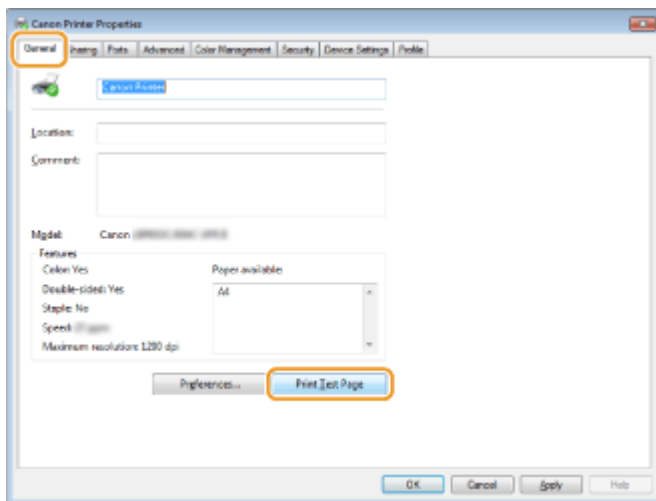

⇒ The test page is printed.

■ Checking the Bit Architecture

If you are not sure whether your computer is running 32-bit or 64-bit Windows follow the procedure below.

- 1 Display [Control Panel].

Windows Vista/7/Server 2008

[Start] ► select [Control Panel].

Windows 8/Server 2012

Right-click the lower-left corner of the screen ► select [Control Panel].

Windows 8.1/Server 2012 R2

Right-click [Start] ► select [Control Panel].

Windows 10/Server 2016

Proceed to step 2.

2 Display [System].**Windows Vista/7/8/Server 2008 R2/Server 2012**

Click [System and Maintenance] or [System and Security] ► [System].

Windows 10/Server 2016

Click [Start] ► [Settings] ► [System] ► select [About].

Windows Server 2008

Double-click [System].

3 Check the bit architecture.**For 32-bit versions**

[32-bit Operating System] is displayed.

For 64-bit versions

[64-bit Operating System] is displayed.

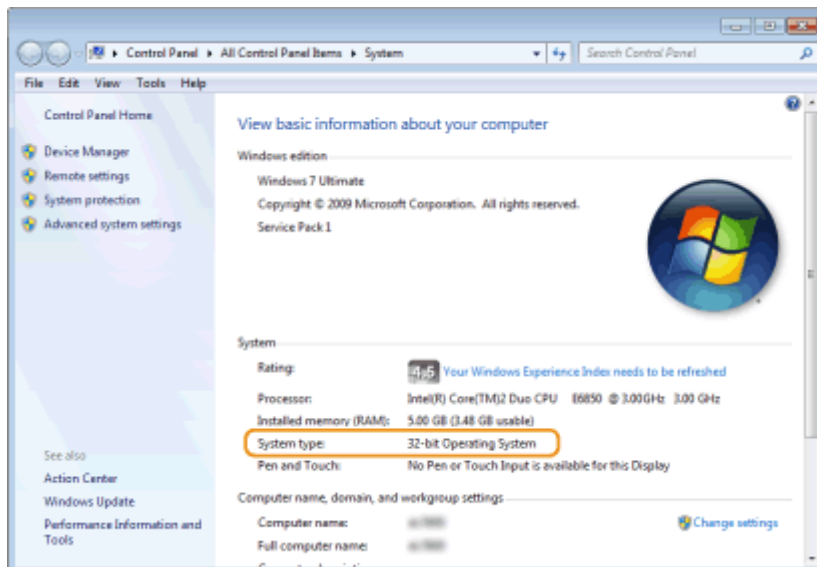
**■ Checking the Printer Port****1 Open the printer folder. ► Displaying the Printer Folder(P. 398)****2 Right-click the printer driver icon for this machine, and click [Printer properties] or [Properties].**

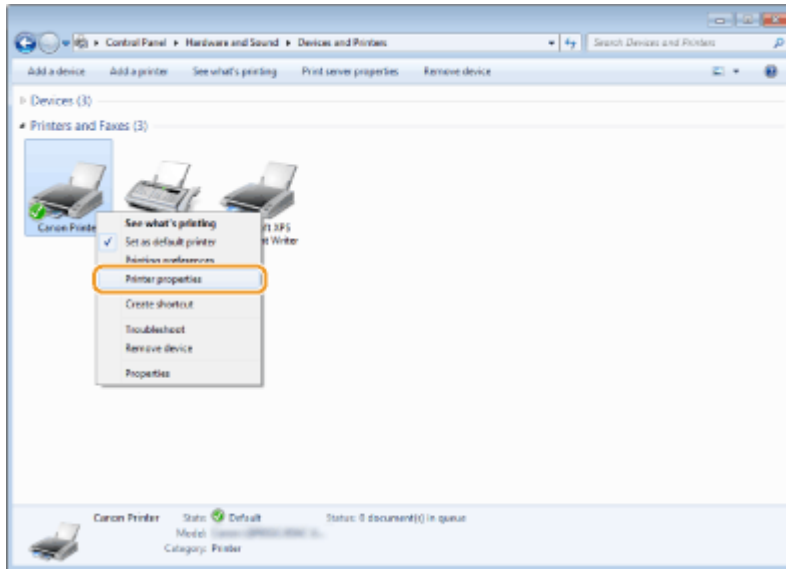

3 In the [Ports] tab, check that the port is selected correctly.

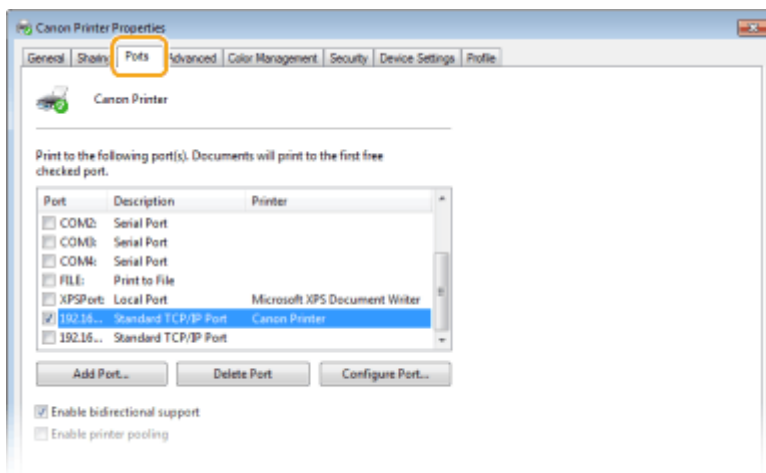

NOTE

If you are using a network connection and have changed the machine's IP address

- You need to add a new port. ► [Configuring Printer Ports\(P. 40\)](#)

■ Checking Bidirectional Communication

1 Open the printer folder. ► [Displaying the Printer Folder\(P. 398\)](#)

2 Right-click the printer driver icon for this machine, and click [Printer properties] or [Properties].

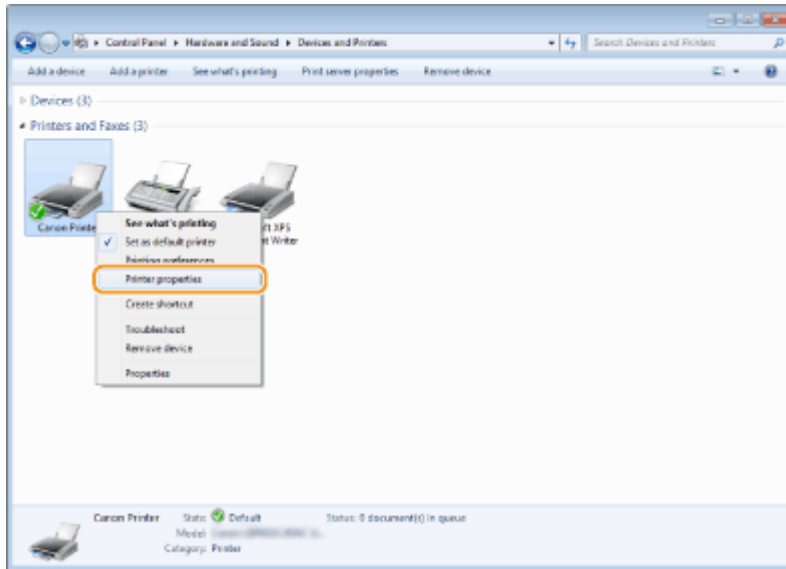

3 In the [Ports] tab, make sure that the [Enable bidirectional support] check box is selected.

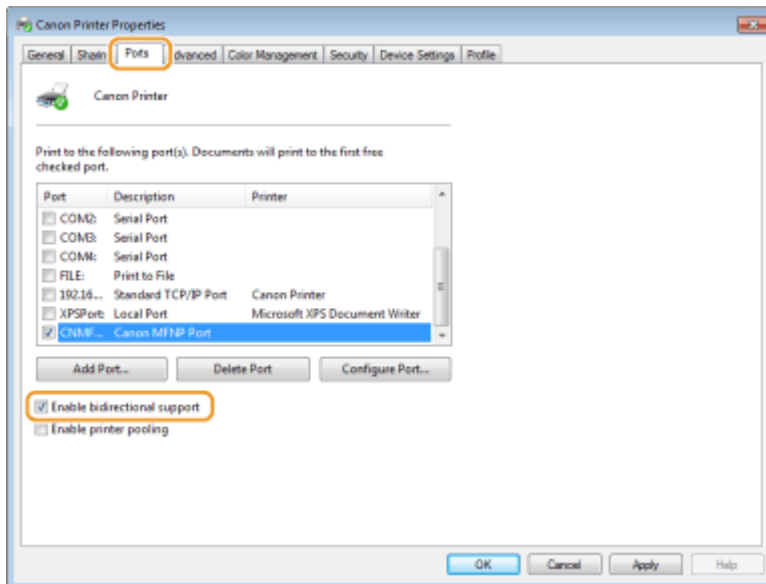

■ **Checking the SSID to Which Your Computer is Connected**

If your computer is connected to a wireless LAN network, click , , or in the system tray to display the SSID of the connected wireless LAN router.

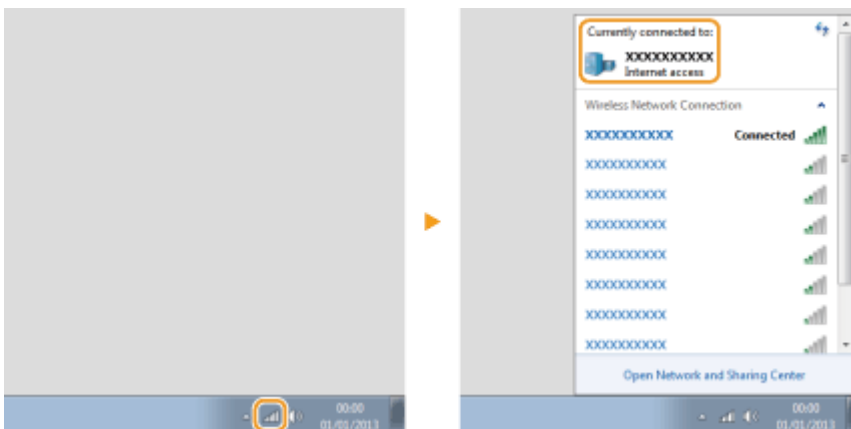

■ When Printing from the Windows Store App

Windows 8/Server 2012

Display the charms on the right side of the screen ► Tap or click [Devices] ► The driver that you use ► [Print].

Windows 8.1/Server 2012 R2

Display the charms on the right side of the screen ► Tap or click [Devices] ► [Print] ► The driver that you use ► [Print].

Windows 10

Tap or click [Print] on the application ► The driver that you use ► [Print].

NOTE

- If you print using this method, only a limited number of print settings are available.
- If the message [The printer requires your attention. Go to the desktop to take care of it.] is displayed, go to the desktop and follow the instructions in the displayed dialog box. This message appears when the machine is set to display the user name during printing and similar instances.

Notice

7YX2-07L

■ IPv6 Ready Logo



The protocol stack included in this product has obtained the IPv6 Ready Logo Phase-2 established by the IPv6 Forum.

■ Product Information required by COMMISSION REGULATION (EU) No.801/2013 amending Regulation (EC) No.1275/2008

Power consumption of a product in networked standby mode where wired network ports are connected and all wireless network ports are activated (if available at the same time).

Model Name	Power consumption of the product in networked standby mode
LBP236dw / LBP233dw	3.0 W or less

NOTE

- The above value(s) are the actual values for a single machine, chosen arbitrarily, and may therefore differ from the value(s) of the actual machine used. Optional network ports are either not connected or not activated in the measurement.

■ WEEE and Battery Directives



Only for European Union and EEA (Norway, Iceland and Liechtenstein)

These symbols indicate that this product is not to be disposed of with your household waste, according to the WEEE Directive (2012/19/EU), the Battery Directive (2006/66/EC) and/or national legislation implementing those Directives. If a chemical symbol is printed beneath the symbol shown above, in accordance with the Battery Directive, this indicates that a heavy metal (Hg = Mercury, Cd = Cadmium, Pb = Lead) is present in this battery or accumulator at a concentration above an applicable threshold specified in the Battery Directive.

This product should be handed over to a designated collection point, e.g., on an authorized one-for-one basis when you buy a new similar product or to an authorized collection site for recycling waste electrical and electronic equipment (EEE) and batteries and accumulators. Improper handling of this type of waste could have a possible impact on the environment and human health due to potentially hazardous substances that are generally associated with EEE. Your cooperation in the correct disposal of this product will contribute to the effective usage of natural resources.

For more information about the recycling of this product, please contact your local city office, waste authority, approved scheme or your household waste disposal service or visit www.canon-europe.com/sustainability/approach/.

■ Environmental Information

Reducing your environmental impact while saving money

Power Consumption and Activation Time

The amount of electricity a device consumes depends on the way the device is used. This product is designed and set in a way to allow you to reduce your electricity costs. After the last print it switches to Ready Mode. In this mode it can print again immediately if required. If the product is not used for a time, the device switches to its Power Save Mode. The devices consume less power (Watt) in these modes.

If you wish to set a longer Activation Time or would like to completely deactivate the Power Save Mode, please consider that this device may then only switch to a lower energy level after a longer period of time or not at all. Canon does not recommend extending the Activation Times from the optimum ones set as default.

Energy Star®

The Energy Star® programme is a voluntary scheme to promote the development and purchase of energy efficient models, which help to minimise environmental impact.

Products which meet the stringent requirements of the Energy Star® programme for both environmental benefits and the amount of energy consumption will carry the Energy Star® logo accordingly.

Paper types

This product can be used to print on both recycled and virgin paper (certified to an environmental stewardship scheme), which complies with EN12281 or a similar quality standard. In addition it can support printing on media down to a weight of 64g/m².

Lighter paper means less resources used and a lower environmental footprint for your printing needs.

Duplex printing (Standard duplex printing products only)

Duplex printing capability enables you to print on both sides automatically, and therefore helps to reduce the use of valuable resources by reducing your paper consumption.

The duplex function has been auto enabled during the set up and driver installation and Canon strongly recommends that you do not disable this function. You should continue to use the duplex function to reduce the environmental impact of your work with this product at all times.

■ Trademarks

Adobe and Reader are registered trademarks of Adobe Systems Incorporated in the United States and/or other countries.

Apple, Bonjour, iPad, iPhone, iPod touch, Safari, Mac, macOS and OS X are trademarks of Apple Inc.

iOS is a trademark or registered trademark of Cisco in the U.S. and other countries and is used under license.

Mopria®, the Mopria® Logo and the Mopria® Alliance logo are registered trademarks and service marks of Mopria Alliance, Inc. in the United States and other countries. Unauthorized use is strictly prohibited.

Google Chrome and Android are trademarks of Google LLC.

This product contains the Universal Font Scaling Technology or UFST® under license from Monotype Imaging, Inc.

UFST® is a trademark of Monotype Imaging, Inc. registered in the United States Patent and Trademark Office and may be registered in certain jurisdictions.

UFST: Copyright © 1989 - 1996, 1997, 2003, 2004, 2008, 2014 all rights reserved, by Monotype Imaging Inc.



Protected by U.S. Patents 5,737,599; 5,781,785; 5,819,301; 5,929,866; 5,943,063; 6,073,148; 6,515,763; 6,639,593; 6,754,382; 7,046,403; 7,213,269; 7,242,415; Patents pending in the U.S. and other countries.

All instances of the name PostScript in the text are references to the PostScript language as defined by Adobe Systems Incorporated unless otherwise stated. The name PostScript also is used as a product trademark for Adobe Systems' implementation of the PostScript language interpreter.

Except as otherwise stated, any reference to a "PostScript printing device," "PostScript display device," or similar item refers to a printing device, display device or item (respectively) that contains PostScript technology created or licensed by Adobe Systems Incorporated and not to devices or items that purport to be merely compatible with the PostScript language.

Adobe, the Adobe logo, PostScript, the PostScript logo, and PostScript 3 are either registered trademarks or trademarks of Adobe Systems Incorporated in the United States and/or other countries.

Linux is a registered trademark of Linus Torvalds. Microsoft and Windows are either registered trademarks or trademarks of Microsoft Corporation in the United States and/or other countries.

All other trademarks are the property of their respective owners.



Copyright © 2008 Adobe Systems Incorporated. All rights reserved.

Protected by U.S. Patents 6,185,684; 6,205,549; 7,213,269; 7,272,628; 7,278,168; Patents pending in the U.S. and other countries.

All instances of the name PostScript in the text are references to the PostScript language as defined by Adobe Systems Incorporated unless otherwise stated. The name PostScript also is used as a product trademark for Adobe Systems' implementation of the PostScript language interpreter.

Except as otherwise stated, any reference to a "PostScript printing device," "PostScript display device," or similar item refers to a printing device, display device or item (respectively) that contains PostScript technology created or licensed by Adobe Systems Incorporated and not to devices or items that purport to be merely compatible with the PostScript language.

Adobe, the Adobe logo, PostScript, the PostScript Logo, and PostScript 3 are either registered trademarks or trademarks of Adobe Systems Incorporated in the United States and/or other countries.

All other trademarks are the property of their respective owners.

All brand names and product names appearing on this document are registered trademarks or trademarks of their respective owners.

All other trademarks are the property of their respective owners.

■ Disclaimers

- The information in this document is subject to change without notice.
- CANON INC. MAKES NO WARRANTY OF ANY KIND WITH REGARD TO THIS MATERIAL, EITHER EXPRESS OR IMPLIED, EXCEPT AS PROVIDED HEREIN, INCLUDING WITHOUT LIMITATION, THEREOF, WARRANTIES AS TO MARKETABILITY, MERCHANTABILITY, FITNESS FOR A PARTICULAR PURPOSE OF USE, OR NON-INFRINGEMENT. CANON INC. SHALL

NOT BE LIABLE FOR ANY DIRECT, INCIDENTAL, OR CONSEQUENTIAL DAMAGES OF ANY NATURE, OR LOSSES OR EXPENSES RESULTING FROM THE USE OF THIS MATERIAL.

- If you are unable to view the manual in PDF format, download Adobe Acrobat Reader from the Adobe Systems website (<https://get.adobe.com/reader/>).

■ Copyright

Unauthorized reproduction of the contents of this document in whole or in part is prohibited.

■ When disposing of used toner cartridges

- To protect the environment and make more effective use of resources, Canon promotes the recovery and recycling of used toner cartridges. Please cooperate in the recovery of toner cartridges (resource reuse). For details on resource reuse, see the Canon website:
global.canon/ctc
When disposing of toner cartridges, pack them in their original packaging to prevent toner dispersal and dispose of the cartridges in accordance with your local government instructions.

V_210303

This Font Software is licensed under the SIL Open Font License, Version 1.1.

This license is copied below, and is also available with a FAQ at: <http://scripts.sil.org/OFL>

SIL OPEN FONT LICENSE Version 1.1 - 26 February 2007

PREAMBLE

The goals of the Open Font License (OFL) are to stimulate worldwide development of collaborative font projects, to support the font creation efforts of academic and linguistic communities, and to provide a free and open framework in which fonts may be shared and improved in partnership with others.

The OFL allows the licensed fonts to be used, studied, modified and redistributed freely as long as they are not sold by themselves. The fonts, including any derivative works, can be bundled, embedded, redistributed and/or sold with any software provided that any reserved names are not used by derivative works. The fonts and derivatives, however, cannot be released under any other type of license. The requirement for fonts to remain under this license does not apply to any document created using the fonts or their derivatives.

DEFINITIONS

"Font Software" refers to the set of files released by the Copyright Holder(s) under this license and clearly marked as such. This may include source files, build scripts and documentation.

"Reserved Font Name" refers to any names specified as such after the copyright statement(s).

"Original Version" refers to the collection of Font Software components as distributed by the Copyright Holder(s).

"Modified Version" refers to any derivative made by adding to, deleting, or substituting -- in part or in whole -- any of the components of the Original Version, by changing formats or by porting the Font Software to a new environment.

"Author" refers to any designer, engineer, programmer, technical writer or other person who contributed to the Font Software.

PERMISSION & CONDITIONS

Permission is hereby granted, free of charge, to any person obtaining a copy of the Font Software, to use, study, copy, merge, embed, modify, redistribute, and sell modified and unmodified copies of the Font Software, subject to the following conditions:

- 1) Neither the Font Software nor any of its individual components, in Original or Modified Versions, may be sold by itself.
- 2) Original or Modified Versions of the Font Software may be bundled, redistributed and/or sold with any software, provided that each copy contains the above copyright notice and this license. These can be included either as stand-alone text files, human-readable headers or in the appropriate machine-readable metadata fields within text or binary files as long as those fields can be easily viewed by the user.
- 3) No Modified Version of the Font Software may use the Reserved Font Name(s) unless explicit written permission is granted by the corresponding Copyright Holder. This restriction only applies to the primary font name as presented to the users.
- 4) The name(s) of the Copyright Holder(s) or the Author(s) of the Font Software shall not be used to promote, endorse or advertise any Modified Version, except to acknowledge the contribution(s) of the Copyright Holder(s) and the Author(s) or with their explicit written permission.
- 5) The Font Software, modified or unmodified, in part or in whole, must be distributed entirely under this license, and must not be distributed under any other license. The requirement for fonts to remain under this license does not apply to any document created using the Font Software.

TERMINATION

This license becomes null and void if any of the above conditions are not met.

DISCLAIMER

THE FONT SOFTWARE IS PROVIDED "AS IS", WITHOUT WARRANTY OF ANY KIND, EXPRESS OR IMPLIED, INCLUDING BUT NOT LIMITED TO ANY WARRANTIES OF MERCHANTABILITY, FITNESS FOR A PARTICULAR PURPOSE AND NONINFRINGEMENT OF COPYRIGHT, PATENT, TRADEMARK, OR OTHER RIGHT. IN NO EVENT SHALL THE COPYRIGHT HOLDER BE LIABLE FOR ANY CLAIM, DAMAGES OR OTHER LIABILITY, INCLUDING ANY GENERAL, SPECIAL, INDIRECT, INCIDENTAL, OR CONSEQUENTIAL DAMAGES, WHETHER IN AN ACTION OF CONTRACT, TORT OR OTHERWISE, ARISING FROM, OUT OF THE USE OR INABILITY TO USE THE FONT SOFTWARE OR FROM OTHER DEALINGS IN THE FONT SOFTWARE.

Third-Party Services

If you use third-party services through the PRODUCT, use of the services are subjected the conditions below.

When you access and/or obtain some third party content (such as text, images, videos, audios, or software) through the SOFTWARE, except as expressly permitted by the content owner or by applicable law, you may not (a) scrape, build databases or otherwise create permanent copies of such content, or keep cached copies longer than permitted by the cache header; (b) copy, translate, modify, create a derivative work of, sell, lease, lend, convey, distribute, publicly display or sublicense to any third party; (c) misrepresent the source or ownership; and (d) remove, obscure, or alter any copyright, trademark or other proprietary rights notices, falsify or delete any author attributions, legal notices or other labels of the origin or source of material.

The Software Subjected to Other License Conditions

Please refer to Contents of Software and respective License terms below, for more detail and corresponding license conditions.

Contents of Software

Names of Software	page
1. Adobe PostScript 3.....	3
2. expat.....	10
3. libjingle.....	11
4. Net-SNMP.....	12

1.Adobe PostScript 3

Copyright 2007–2008 Adobe Systems Incorporated and its licensors. All rights reserved.

Portions include software under the following terms:

This product contains either BSAFE and/or TIPEM software by RSA Security Inc.

Portions of Pool.c_Copyright 1987 – NeXT, Inc., and portions of Graphics.c_Copyright 1988 NeXT, Inc. as an unpublished work. All Rights Reserved.

The Apache Software License, Version 1.1

This product includes software developed by the Apache Software Foundation (<http://www.apache.org/>).

Portions Copyright (c) 1998–2000 The Apache Software Foundation. All rights reserved.

Redistribution and use in source and binary forms, with or without modification, are permitted provided that the following conditions are met:

1. Redistributions of source code must retain the above copyright notice, this list of conditions and the following disclaimer.
2. Redistributions in binary form must reproduce the above copyright notice, this list of conditions and the following disclaimer in the documentation and/or other materials provided with the distribution.
3. The end–user documentation included with the redistribution, if any, must include the following acknowledgment:

"This product includes software developed by the Apache Software Foundation (<http://www.apache.org/>)."

Alternately, this acknowledgment may appear in the software itself, if and wherever such third–party acknowledgments normally appear.

4. The names "Xerces" and "Apache Software Foundation" must not be used to endorse or promote products derived from this software without prior written permission. For written permission, please contact apache@apache.org.
5. Products derived from this software may not be called "Apache", nor may "Apache" appear in their name, without prior written permission of the Apache Software Foundation.

THIS SOFTWARE IS PROVIDED ``AS IS" AND ANY EXPRESSED OR IMPLIED WARRANTIES, INCLUDING,

BUT NOT LIMITED TO, THE IMPLIED WARRANTIES OF MERCHANTABILITY AND FITNESS FOR A PARTICULAR PURPOSE ARE DISCLAIMED. IN NO EVENT SHALL THE APACHE SOFTWARE FOUNDATION OR ITS CONTRIBUTORS BE LIABLE FOR ANY DIRECT, INDIRECT, INCIDENTAL, SPECIAL, EXEMPLARY, OR CONSEQUENTIAL DAMAGES (INCLUDING, BUT NOT LIMITED TO, PROCUREMENT OF SUBSTITUTE GOODS OR SERVICES; LOSS OF USE, DATA, OR PROFITS; OR BUSINESS INTERRUPTION) HOWEVER CAUSED AND ON ANY THEORY OF LIABILITY, WHETHER IN CONTRACT, STRICT LIABILITY, OR TORT (INCLUDING NEGLIGENCE OR OTHERWISE) ARISING IN ANY WAY OUT OF THE USE OF THIS SOFTWARE, EVEN IF ADVISED OF THE POSSIBILITY OF SUCH DAMAGE.

This software consists of voluntary contributions made by many individuals on behalf of the Apache Software Foundation and was originally based on software copyright (c) 1999, International Business Machines, Inc., <http://www.ibm.com>. For more information on the Apache Software Foundation, please see <http://www.apache.org/>.

This product includes software developed by the University of California, Berkeley and its contributors.

Portions Copyright (c) 1990 The Regents of the University of California. All rights reserved.

Redistribution and use in source and binary forms, with or without modification, are permitted provided that the following conditions are met:

1. Redistributions of source code must retain the above copyright notice, this list of conditions and the following disclaimer.
2. Redistributions in binary form must reproduce the above copyright notice, this list of conditions and the following disclaimer in the documentation and/or other materials provided with the distribution.
3. All advertising materials mentioning features or use of this software must display the following acknowledgement:

This product includes software developed by the University of California, Berkeley and its contributors.

4. Neither the name of the University nor the names of its contributors may be used to endorse or promote products derived from this software without specific prior written permission.

THIS SOFTWARE IS PROVIDED BY THE REGENTS AND CONTRIBUTORS "AS IS" AND ANY EXPRESS OR IMPLIED WARRANTIES, INCLUDING, BUT NOT LIMITED TO, THE IMPLIED WARRANTIES OF MERCHANTABILITY AND FITNESS FOR A PARTICULAR PURPOSE ARE DISCLAIMED. IN NO EVENT SHALL THE REGENTS OR CONTRIBUTORS BE LIABLE FOR ANY DIRECT, INDIRECT, INCIDENTAL, SPECIAL, EXEMPLARY, OR CONSEQUENTIAL DAMAGES (INCLUDING, BUT NOT LIMITED TO, PROCUREMENT OF SUBSTITUTE GOODS OR SERVICES; LOSS OF USE, DATA, OR PROFITS; OR BUSINESS INTERRUPTION)

HOWEVER CAUSED AND ON ANY THEORY OF LIABILITY, WHETHER IN CONTRACT, STRICT LIABILITY, OR TORT (INCLUDING NEGLIGENCE OR OTHERWISE) ARISING IN ANY WAY OUT OF THE USE OF THIS SOFTWARE, EVEN IF ADVISED OF THE POSSIBILITY OF SUCH DAMAGE.

Portions Copyright (c) 1985, 1986 The Regents of the University of California. All rights reserved.

This code is derived from software contributed to Berkeley by James A. Woods, derived from original work by Spencer Thomas and Joseph Orost.

Redistribution and use in source and binary forms are permitted provided that the above copyright notice and this paragraph are duplicated in all such forms and that any documentation, advertising materials, and other materials related to such distribution and use acknowledge that the software was developed by the University of California, Berkeley. The name of the University may not be used to endorse or promote products derived from this software without specific prior written permission.

THIS SOFTWARE IS PROVIDED ``AS IS" AND WITHOUT ANY EXPRESS OR IMPLIED WARRANTIES, INCLUDING, WITHOUT LIMITATION, THE IMPLIED WARRANTIES OF MERCHANTABILITY AND FITNESS FOR A PARTICULAR PURPOSE.

Portions Copyright (c) 1993 X Consortium

Permission is hereby granted, free of charge, to any person obtaining a copy of this software and associated documentation files (the "Software"), to deal in the Software without restriction, including without limitation the rights to use, copy, modify, merge, publish, distribute, sublicense, and/or sell copies of the Software, and to permit persons to whom the Software is furnished to do so, subject to the following conditions:

The above copyright notice and this permission notice shall be included in all copies or substantial portions of the Software.

THE SOFTWARE IS PROVIDED "AS IS", WITHOUT WARRANTY OF ANY KIND, EXPRESS OR IMPLIED, INCLUDING BUT NOT LIMITED TO THE WARRANTIES OF MERCHANTABILITY, FITNESS FOR A PARTICULAR PURPOSE AND NONINFRINGEMENT. IN NO EVENT SHALL THE X CONSORTIUM BE LIABLE FOR ANY CLAIM, DAMAGES OR OTHER LIABILITY, WHETHER IN AN ACTION OF CONTRACT, TORT OR OTHERWISE, ARISING FROM, OUT OF OR IN CONNECTION WITH THE SOFTWARE OR THE USE OR OTHER DEALINGS IN THE SOFTWARE.

Except as contained in this notice, the name of the X Consortium shall not be used in advertising or

otherwise to promote the sale, use or other dealings in this Software without prior written authorization from the X Consortium.

NOTICE REGARDING SABLOTRON

March 27, 2003

Portions of this product are based on Modifications created from the Original Code known as the "Sablotron XSLT Processor". The Sablotron XSLT Processor is subject to the Mozilla Public License Version 1.1 (the "License"). You may obtain a copy of the License at <http://www.mozilla.org/MPL/>

Software distributed under the License is distributed on an "AS IS" basis, WITHOUT WARRANTY OF ANY KIND, either express or implied. See the License for the specific language governing rights and limitations under the License.

The Original Code is the Sablotron XSLT Processor.

The Initial Developer of the Original Code is Ginger Alliance Ltd. Portions created by Ginger Alliance are Copyright (C) 2000 Ginger Alliance Ltd. All Rights Reserved.

Pursuant to sections 3.2 and 3.6 of the License, the Modifications created by Adobe Systems Incorporated are available as Source Code. The Modifications may be downloaded via the Internet from:

<http://partners.adobe.com/asn/tech/xml/sablotron/index.jsp>

The Original Code may be downloaded via the Internet from:

<https://sourceforge.net/projects/sablotron/>

This product includes software developed by the University of California, Berkeley and its contributors.

Portions Copyright (c) 1982, 1986, 1987, 1988, 1989, 1990, 1991, 1992, 1993, 1994 The Regents of the University of California. All rights reserved.

Redistribution and use in source and binary forms, with or without modification, are permitted provided that the following conditions are met:

1. Redistributions of source code must retain the above copyright notice, this list of conditions and the following disclaimer.
2. Redistributions in binary form must reproduce the above copyright notice, this list of conditions and the following disclaimer in the documentation and/or other materials provided with the distribution.
3. All advertising materials mentioning features or use of this software must display the following acknowledgement: This product includes software developed by the University of California, Berkeley and its contributors.
4. Neither the name of the University nor the names of its contributors may be used to endorse or promote products derived from this software without specific prior written permission.

THIS SOFTWARE IS PROVIDED BY THE REGENTS AND CONTRIBUTORS "AS IS" AND ANY EXPRESS OR IMPLIED WARRANTIES, INCLUDING, BUT NOT LIMITED TO, THE IMPLIED WARRANTIES OF MERCHANTABILITY AND FITNESS FOR A PARTICULAR PURPOSE ARE DISCLAIMED. IN NO EVENT SHALL THE REGENTS OR CONTRIBUTORS BE LIABLE FOR ANY DIRECT, INDIRECT, INCIDENTAL, SPECIAL, EXEMPLARY, OR CONSEQUENTIAL DAMAGES (INCLUDING, BUT NOT LIMITED TO, PROCUREMENT OF SUBSTITUTE GOODS OR SERVICES; LOSS OF USE, DATA, OR PROFITS; OR BUSINESS INTERRUPTION) HOWEVER CAUSED AND ON ANY THEORY OF LIABILITY, WHETHER IN CONTRACT, STRICT LIABILITY, OR TORT (INCLUDING NEGLIGENCE OR OTHERWISE) ARISING IN ANY WAY OUT OF THE USE OF THIS SOFTWARE, EVEN IF ADVISED OF THE POSSIBILITY OF SUCH DAMAGE.

Portions Copyright (c) 2001 by Andrei Alexandrescu. This code accompanies the book: Alexandrescu, Andrei. "Modern C++ Design: Generic Programming and Design Patterns Applied". Copyright (c) 2001. Addison-Wesley.

Permission to use, copy, modify, distribute and sell this software for any purpose is hereby granted without fee, provided that the above copyright notice appear in all copies and that both that copyright notice and this permission notice appear in supporting documentation. The author or Addison-Wesley Longman make no representations about the suitability of this software for any purpose. It is provided "as is" without express or implied warranty.

Portions developed by the University of California, Berkeley.

Portions Copyright © 1991–2005 Unicode, Inc. All rights reserved. Distributed under the Terms of Use in <http://www.unicode.org/copyright.html>.

Permission is hereby granted, free of charge, to any person obtaining a copy of the Unicode data files and associated documentation (the "Data Files") or Unicode software and associated documentation (the "Software") to deal in the Data Files or Software without restriction, including without limitation

the rights to use, copy, modify, merge, publish, distribute, and/or sell copies of the Data Files or Software, and to permit persons to whom the Data Files or Software are furnished to do so, provided that (a) the above copyright notice(s) and this permission notice appear in all copies of the Data Files or Software, (b) both the above copyright notice(s) and this permission notice appear in associated documentation, and (c) there is clear notice in each modified Data File or in the Software as well as in the documentation associated with the Data File(s) or Software that the data or software has been modified.

THE DATA FILES AND SOFTWARE ARE PROVIDED "AS IS", WITHOUT WARRANTY OF ANY KIND, EXPRESS OR IMPLIED, INCLUDING BUT NOT LIMITED TO THE WARRANTIES OF MERCHANTABILITY, FITNESS FOR A PARTICULAR PURPOSE AND NONINFRINGEMENT OF THIRD PARTY RIGHTS. IN NO EVENT SHALL THE COPYRIGHT HOLDER OR HOLDERS INCLUDED IN THIS NOTICE BE LIABLE FOR ANY CLAIM, OR ANY SPECIAL INDIRECT OR CONSEQUENTIAL DAMAGES, OR ANY DAMAGES WHATSOEVER RESULTING FROM LOSS OF USE, DATA OR PROFITS, WHETHER IN AN ACTION OF CONTRACT, NEGLIGENCE OR OTHER TORTIOUS ACTION, ARISING OUT OF OR IN CONNECTION WITH THE USE OR PERFORMANCE OF THE DATA FILES OR SOFTWARE.

Except as contained in this notice, the name of a copyright holder shall not be used in advertising or otherwise to promote the sale, use or other dealings in these Data Files or Software without prior written authorization of the copyright holder.

Unicode and the Unicode logo are trademarks of Unicode, Inc., and may be registered in some jurisdictions. All other trademarks and registered trademarks mentioned herein are the property of their respective owners.

Adobe shall retain and reproduce, and require its Sublicensees to retain and reproduce JIM's following copyright notice within each copy of the licensed programs in any form, in whole or in part: "© 1981, 1990 JMI Consultants, Inc. All rights reserved."

This product includes software developed by the University of California, Berkeley and its contributors.

Portions Copyright (c) 1990, 1993 The Regents of the University of California. All rights reserved.

This code is derived from software contributed to Berkeley by Chris Torek.

Redistribution and use in source and binary forms, with or without modification, are permitted provided that the following conditions are met:

1. Redistributions of source code must retain the above copyright notice, this list of conditions and

the following disclaimer.

2. Redistributions in binary form must reproduce the above copyright notice, this list of conditions and the following disclaimer in the documentation and/or other materials provided with the distribution.

3. All advertising materials mentioning features or use of this software must display the following acknowledgement:

This product includes software developed by the University of California, Berkeley and its contributors.

4. Neither the name of the University nor the names of its contributors may be used to endorse or promote products derived from this software without specific prior written permission.

THIS SOFTWARE IS PROVIDED BY THE REGENTS AND CONTRIBUTORS "AS IS" AND ANY EXPRESS OR IMPLIED WARRANTIES, INCLUDING, BUT NOT LIMITED TO, THE IMPLIED WARRANTIES OF MERCHANTABILITY AND FITNESS FOR A PARTICULAR PURPOSE ARE DISCLAIMED. IN NO EVENT SHALL THE REGENTS OR CONTRIBUTORS BE LIABLE FOR ANY DIRECT, INDIRECT, INCIDENTAL, SPECIAL, EXEMPLARY, OR CONSEQUENTIAL DAMAGES (INCLUDING, BUT NOT LIMITED TO, PROCUREMENT OF SUBSTITUTE GOODS OR SERVICES; LOSS OF USE, DATA, OR PROFITS; OR BUSINESS INTERRUPTION) HOWEVER CAUSED AND ON ANY THEORY OF LIABILITY, WHETHER IN CONTRACT, STRICT LIABILITY, OR TORT (INCLUDING NEGLIGENCE OR OTHERWISE) ARISING IN ANY WAY OUT OF THE USE OF THIS SOFTWARE, EVEN IF ADVISED OF THE POSSIBILITY OF SUCH DAMAGE.

The Loki Library

Portions Copyright (c) 2001 by Andrei Alexandrescu // This code accompanies the book: Alexandrescu, Andrei. "Modern C++ Design: Generic Programming and Design Patterns Applied". Copyright (c) 2001. Addison-Wesley.

Permission to use, copy, modify, distribute and sell this software for any purpose is hereby granted without fee, provided that the above copyright notice appear in all copies and that both that copyright notice and this permission notice appear in supporting documentation. The author or Addison-Wesley Longman make no representations about the suitability of this software for any purpose. It is provided "as is" without express or implied warranty.

Updated Information/Additional Third Party Code Information available at <http://www.adobe.com/go/thirdparty> .

2. expat

Copyright (c) 1998, 1999, 2000 Thai Open Source Software Center Ltd
and Clark Cooper

Copyright (c) 2001, 2002, 2003, 2004, 2005, 2006 Expat maintainers.

Permission is hereby granted, free of charge, to any person obtaining a copy of this software and associated documentation files (the "Software"), to deal in the Software without restriction, including without limitation the rights to use, copy, modify, merge, publish, distribute, sublicense, and/or sell copies of the Software, and to permit persons to whom the Software is furnished to do so, subject to the following conditions:

The above copyright notice and this permission notice shall be included in all copies or substantial portions of the Software.

THE SOFTWARE IS PROVIDED "AS IS", WITHOUT WARRANTY OF ANY KIND, EXPRESS OR IMPLIED, INCLUDING BUT NOT LIMITED TO THE WARRANTIES OF MERCHANTABILITY, FITNESS FOR A PARTICULAR PURPOSE AND NONINFRINGEMENT. IN NO EVENT SHALL THE AUTHORS OR COPYRIGHT HOLDERS BE LIABLE FOR ANY CLAIM, DAMAGES OR OTHER LIABILITY, WHETHER IN AN ACTION OF CONTRACT, TORT OR OTHERWISE, ARISING FROM, OUT OF OR IN CONNECTION WITH THE SOFTWARE OR THE USE OR OTHER DEALINGS IN THE SOFTWARE.

3. libjingle

Copyright 2004--2007, Google Inc.

Redistribution and use in source and binary forms, with or without modification, are permitted provided that the following conditions are met:

1. Redistributions of source code must retain the above copyright notice, this list of conditions and the following disclaimer.
2. Redistributions in binary form must reproduce the above copyright notice, this list of conditions and the following disclaimer in the documentation and/or other materials provided with the distribution.
3. The name of the author may not be used to endorse or promote products derived from this software without specific prior written permission.

THIS SOFTWARE IS PROVIDED BY THE AUTHOR ``AS IS" AND ANY EXPRESS OR IMPLIED WARRANTIES, INCLUDING, BUT NOT LIMITED TO, THE IMPLIED WARRANTIES OF MERCHANTABILITY AND FITNESS FOR A PARTICULAR PURPOSE ARE DISCLAIMED. IN NO EVENT SHALL THE AUTHOR BE LIABLE FOR ANY DIRECT, INDIRECT, INCIDENTAL, SPECIAL, EXEMPLARY, OR CONSEQUENTIAL DAMAGES (INCLUDING, BUT NOT LIMITED TO, PROCUREMENT OF SUBSTITUTE GOODS OR SERVICES; LOSS OF USE, DATA, OR PROFITS; OR BUSINESS INTERRUPTION) HOWEVER CAUSED AND ON ANY THEORY OF LIABILITY, WHETHER IN CONTRACT, STRICT LIABILITY, OR TORT (INCLUDING NEGLIGENCE OR OTHERWISE) ARISING IN ANY WAY OUT OF THE USE OF THIS SOFTWARE, EVEN IF ADVISED OF THE POSSIBILITY OF SUCH DAMAGE.

4. Net-SNMP

Various copyrights apply to this package, listed in various separate parts below. Please make sure that you read all the parts.

----- Part 1: CMU/UCD copyright notice: (BSD like) -----

Copyright 1989, 1991, 1992 by Carnegie Mellon University

Derivative Work - 1996, 1998-2000

Copyright 1996, 1998-2000 The Regents of the University of California

All Rights Reserved

Permission to use, copy, modify and distribute this software and its documentation for any purpose and without fee is hereby granted, provided that the above copyright notice appears in all copies and that both that copyright notice and this permission notice appear in supporting documentation, and that the name of CMU and The Regents of the University of California not be used in advertising or publicity pertaining to distribution of the software without specific written permission.

CMU AND THE REGENTS OF THE UNIVERSITY OF CALIFORNIA DISCLAIM ALL WARRANTIES WITH REGARD TO THIS SOFTWARE, INCLUDING ALL IMPLIED WARRANTIES OF MERCHANTABILITY AND FITNESS. IN NO EVENT SHALL CMU OR THE REGENTS OF THE UNIVERSITY OF CALIFORNIA BE LIABLE FOR ANY SPECIAL, INDIRECT OR CONSEQUENTIAL DAMAGES OR ANY DAMAGES WHATSOEVER RESULTING FROM THE LOSS OF USE, DATA OR PROFITS, WHETHER IN AN ACTION OF CONTRACT, NEGLIGENCE OR OTHER TORTIOUS ACTION, ARISING OUT OF OR IN CONNECTION WITH THE USE OR PERFORMANCE OF THIS SOFTWARE.

----- Part 2: Networks Associates Technology, Inc copyright notice (BSD) -----

Copyright (c) 2001-2003, Networks Associates Technology, Inc

All rights reserved.

Redistribution and use in source and binary forms, with or without modification, are permitted provided that the following conditions are met:

- * Redistributions of source code must retain the above copyright notice, this list of conditions and the following disclaimer.
- * Redistributions in binary form must reproduce the above copyright notice, this list of conditions and the following disclaimer in the documentation and/or other materials provided with the distribution.
- * Neither the name of the Networks Associates Technology, Inc nor the names of its contributors may be used to endorse or promote products derived from this software without specific prior written permission.

THIS SOFTWARE IS PROVIDED BY THE COPYRIGHT HOLDERS AND CONTRIBUTORS "AS IS" AND ANY EXPRESS OR IMPLIED WARRANTIES, INCLUDING, BUT NOT LIMITED TO, THE IMPLIED WARRANTIES OF MERCHANTABILITY AND FITNESS FOR A PARTICULAR PURPOSE ARE DISCLAIMED. IN NO EVENT SHALL THE COPYRIGHT HOLDERS OR CONTRIBUTORS BE LIABLE FOR ANY DIRECT, INDIRECT, INCIDENTAL, SPECIAL, EXEMPLARY, OR CONSEQUENTIAL DAMAGES (INCLUDING, BUT NOT LIMITED TO, PROCUREMENT OF SUBSTITUTE GOODS OR SERVICES; LOSS OF USE, DATA, OR PROFITS; OR BUSINESS INTERRUPTION) HOWEVER CAUSED AND ON ANY THEORY OF LIABILITY, WHETHER IN CONTRACT, STRICT LIABILITY, OR TORT (INCLUDING NEGLIGENCE OR OTHERWISE) ARISING IN ANY WAY OUT OF THE USE OF THIS SOFTWARE, EVEN IF ADVISED OF THE POSSIBILITY OF SUCH DAMAGE.

----- Part 3: Cambridge Broadband Ltd. copyright notice (BSD) -----

Portions of this code are copyright (c) 2001–2003, Cambridge Broadband Ltd.
All rights reserved.

Redistribution and use in source and binary forms, with or without modification, are permitted provided that the following conditions are met:

- * Redistributions of source code must retain the above copyright notice,

this list of conditions and the following disclaimer.

- * Redistributions in binary form must reproduce the above copyright notice, this list of conditions and the following disclaimer in the documentation and/or other materials provided with the distribution.

- * The name of Cambridge Broadband Ltd. may not be used to endorse or promote products derived from this software without specific prior written permission.

THIS SOFTWARE IS PROVIDED BY THE COPYRIGHT HOLDER "AS IS" AND ANY EXPRESS OR IMPLIED WARRANTIES, INCLUDING, BUT NOT LIMITED TO, THE IMPLIED WARRANTIES OF MERCHANTABILITY AND FITNESS FOR A PARTICULAR PURPOSE ARE DISCLAIMED. IN NO EVENT SHALL THE COPYRIGHT HOLDER BE LIABLE FOR ANY DIRECT, INDIRECT, INCIDENTAL, SPECIAL, EXEMPLARY, OR CONSEQUENTIAL DAMAGES (INCLUDING, BUT NOT LIMITED TO, PROCUREMENT OF SUBSTITUTE GOODS OR SERVICES; LOSS OF USE, DATA, OR PROFITS; OR BUSINESS INTERRUPTION) HOWEVER CAUSED AND ON ANY THEORY OF LIABILITY, WHETHER IN CONTRACT, STRICT LIABILITY, OR TORT (INCLUDING NEGLIGENCE OR OTHERWISE) ARISING IN ANY WAY OUT OF THE USE OF THIS SOFTWARE, EVEN IF ADVISED OF THE POSSIBILITY OF SUCH DAMAGE.

----- Part 4: Sun Microsystems, Inc. copyright notice (BSD) -----

Copyright (c) 2003 Sun Microsystems, Inc., 4150 Network Circle, Santa Clara, California 95054, U.S.A. All rights reserved.

Use is subject to license terms below.

This distribution may include materials developed by third parties.

Sun, Sun Microsystems, the Sun logo and Solaris are trademarks or registered trademarks of Sun Microsystems, Inc. in the U.S. and other countries.

Redistribution and use in source and binary forms, with or without modification, are permitted provided that the following conditions are met:

- * Redistributions of source code must retain the above copyright notice, this list of conditions and the following disclaimer.
- * Redistributions in binary form must reproduce the above copyright notice, this list of conditions and the following disclaimer in the documentation and/or other materials provided with the distribution.
- * Neither the name of the Sun Microsystems, Inc. nor the names of its contributors may be used to endorse or promote products derived from this software without specific prior written permission.

THIS SOFTWARE IS PROVIDED BY THE COPYRIGHT HOLDERS AND CONTRIBUTORS "AS IS" AND ANY EXPRESS OR IMPLIED WARRANTIES, INCLUDING, BUT NOT LIMITED TO, THE IMPLIED WARRANTIES OF MERCHANTABILITY AND FITNESS FOR A PARTICULAR PURPOSE ARE DISCLAIMED. IN NO EVENT SHALL THE COPYRIGHT HOLDERS OR CONTRIBUTORS BE LIABLE FOR ANY DIRECT, INDIRECT, INCIDENTAL, SPECIAL, EXEMPLARY, OR CONSEQUENTIAL DAMAGES (INCLUDING, BUT NOT LIMITED TO, PROCUREMENT OF SUBSTITUTE GOODS OR SERVICES; LOSS OF USE, DATA, OR PROFITS; OR BUSINESS INTERRUPTION) HOWEVER CAUSED AND ON ANY THEORY OF LIABILITY, WHETHER IN CONTRACT, STRICT LIABILITY, OR TORT (INCLUDING NEGLIGENCE OR OTHERWISE) ARISING IN ANY WAY OUT OF THE USE OF THIS SOFTWARE, EVEN IF ADVISED OF THE POSSIBILITY OF SUCH DAMAGE.

----- Part 5: Sparta, Inc copyright notice (BSD) -----

Copyright (c) 2003–2013, Sparta, Inc
All rights reserved.

Redistribution and use in source and binary forms, with or without modification, are permitted provided that the following conditions are met:

- * Redistributions of source code must retain the above copyright notice, this list of conditions and the following disclaimer.
- * Redistributions in binary form must reproduce the above copyright notice, this list of conditions and the following disclaimer in the documentation and/or other materials provided with the distribution.

- * Neither the name of Sparta, Inc nor the names of its contributors may be used to endorse or promote products derived from this software without specific prior written permission.

THIS SOFTWARE IS PROVIDED BY THE COPYRIGHT HOLDERS AND CONTRIBUTORS "AS IS" AND ANY EXPRESS OR IMPLIED WARRANTIES, INCLUDING, BUT NOT LIMITED TO, THE IMPLIED WARRANTIES OF MERCHANTABILITY AND FITNESS FOR A PARTICULAR PURPOSE ARE DISCLAIMED. IN NO EVENT SHALL THE COPYRIGHT HOLDERS OR CONTRIBUTORS BE LIABLE FOR ANY DIRECT, INDIRECT, INCIDENTAL, SPECIAL, EXEMPLARY, OR CONSEQUENTIAL DAMAGES (INCLUDING, BUT NOT LIMITED TO, PROCUREMENT OF SUBSTITUTE GOODS OR SERVICES; LOSS OF USE, DATA, OR PROFITS; OR BUSINESS INTERRUPTION) HOWEVER CAUSED AND ON ANY THEORY OF LIABILITY, WHETHER IN CONTRACT, STRICT LIABILITY, OR TORT (INCLUDING NEGLIGENCE OR OTHERWISE) ARISING IN ANY WAY OUT OF THE USE OF THIS SOFTWARE, EVEN IF ADVISED OF THE POSSIBILITY OF SUCH DAMAGE.

----- Part 6: Cisco/BUPTNIC copyright notice (BSD) -----

Copyright (c) 2004, Cisco, Inc and Information Network
Center of Beijing University of Posts and Telecommunications.
All rights reserved.

Redistribution and use in source and binary forms, with or without modification, are permitted provided that the following conditions are met:

- * Redistributions of source code must retain the above copyright notice, this list of conditions and the following disclaimer.
- * Redistributions in binary form must reproduce the above copyright notice, this list of conditions and the following disclaimer in the documentation and/or other materials provided with the distribution.
- * Neither the name of Cisco, Inc, Beijing University of Posts and Telecommunications, nor the names of their contributors may be used to endorse or promote products derived from this software without specific prior written permission.

THIS SOFTWARE IS PROVIDED BY THE COPYRIGHT HOLDERS AND CONTRIBUTORS ``AS IS" AND ANY EXPRESS OR IMPLIED WARRANTIES, INCLUDING, BUT NOT LIMITED TO, THE IMPLIED WARRANTIES OF MERCHANTABILITY AND FITNESS FOR A PARTICULAR PURPOSE ARE DISCLAIMED. IN NO EVENT SHALL THE COPYRIGHT HOLDERS OR CONTRIBUTORS BE LIABLE FOR ANY DIRECT, INDIRECT, INCIDENTAL, SPECIAL, EXEMPLARY, OR CONSEQUENTIAL DAMAGES (INCLUDING, BUT NOT LIMITED TO, PROCUREMENT OF SUBSTITUTE GOODS OR SERVICES; LOSS OF USE, DATA, OR PROFITS; OR BUSINESS INTERRUPTION) HOWEVER CAUSED AND ON ANY THEORY OF LIABILITY, WHETHER IN CONTRACT, STRICT LIABILITY, OR TORT (INCLUDING NEGLIGENCE OR OTHERWISE) ARISING IN ANY WAY OUT OF THE USE OF THIS SOFTWARE, EVEN IF ADVISED OF THE POSSIBILITY OF SUCH DAMAGE.

----- Part 7: Fabasoft R&D Software GmbH & Co KG copyright notice (BSD) -----

Copyright (c) Fabasoft R&D Software GmbH & Co KG, 2003

oss@fabasoft.com

Author: Bernhard Penz <bernhard.penz@fabasoft.com>

Redistribution and use in source and binary forms, with or without modification, are permitted provided that the following conditions are met:

- * Redistributions of source code must retain the above copyright notice, this list of conditions and the following disclaimer.
- * Redistributions in binary form must reproduce the above copyright notice, this list of conditions and the following disclaimer in the documentation and/or other materials provided with the distribution.
- * The name of Fabasoft R&D Software GmbH & Co KG or any of its subsidiaries, brand or product names may not be used to endorse or promote products derived from this software without specific prior written permission.

THIS SOFTWARE IS PROVIDED BY THE COPYRIGHT HOLDER ``AS IS" AND ANY EXPRESS OR IMPLIED WARRANTIES, INCLUDING, BUT NOT LIMITED TO, THE IMPLIED WARRANTIES OF MERCHANTABILITY AND FITNESS FOR A PARTICULAR PURPOSE ARE DISCLAIMED. IN NO EVENT SHALL THE COPYRIGHT HOLDER BE LIABLE FOR ANY DIRECT, INDIRECT, INCIDENTAL, SPECIAL, EXEMPLARY, OR CONSEQUENTIAL DAMAGES (INCLUDING, BUT NOT LIMITED TO, PROCUREMENT OF

SUBSTITUTE GOODS OR SERVICES; LOSS OF USE, DATA, OR PROFITS; OR BUSINESS INTERRUPTION) HOWEVER CAUSED AND ON ANY THEORY OF LIABILITY, WHETHER IN CONTRACT, STRICT LIABILITY, OR TORT (INCLUDING NEGLIGENCE OR OTHERWISE) ARISING IN ANY WAY OUT OF THE USE OF THIS SOFTWARE, EVEN IF ADVISED OF THE POSSIBILITY OF SUCH DAMAGE.

----- Part 8: Apple Inc. copyright notice (BSD) -----

Copyright (c) 2007 Apple Inc. All rights reserved.

Redistribution and use in source and binary forms, with or without modification, are permitted provided that the following conditions are met:

1. Redistributions of source code must retain the above copyright notice, this list of conditions and the following disclaimer.
2. Redistributions in binary form must reproduce the above copyright notice, this list of conditions and the following disclaimer in the documentation and/or other materials provided with the distribution.
3. Neither the name of Apple Inc. ("Apple") nor the names of its contributors may be used to endorse or promote products derived from this software without specific prior written permission.

THIS SOFTWARE IS PROVIDED BY APPLE AND ITS CONTRIBUTORS "AS IS" AND ANY EXPRESS OR IMPLIED WARRANTIES, INCLUDING, BUT NOT LIMITED TO, THE IMPLIED WARRANTIES OF MERCHANTABILITY AND FITNESS FOR A PARTICULAR PURPOSE ARE DISCLAIMED. IN NO EVENT SHALL APPLE OR ITS CONTRIBUTORS BE LIABLE FOR ANY DIRECT, INDIRECT, INCIDENTAL, SPECIAL, EXEMPLARY, OR CONSEQUENTIAL DAMAGES (INCLUDING, BUT NOT LIMITED TO, PROCUREMENT OF SUBSTITUTE GOODS OR SERVICES; LOSS OF USE, DATA, OR PROFITS; OR BUSINESS INTERRUPTION) HOWEVER CAUSED AND ON ANY THEORY OF LIABILITY, WHETHER IN CONTRACT, STRICT LIABILITY, OR TORT (INCLUDING NEGLIGENCE OR OTHERWISE) ARISING IN ANY WAY OUT OF THE USE OF THIS SOFTWARE, EVEN IF ADVISED OF THE POSSIBILITY OF SUCH DAMAGE.

----- Part 9: ScienceLogic, LLC copyright notice (BSD) -----

Copyright (c) 2009, ScienceLogic, LLC
All rights reserved.

Redistribution and use in source and binary forms, with or without modification, are permitted provided that the following conditions are met:

- * Redistributions of source code must retain the above copyright notice, this list of conditions and the following disclaimer.
- * Redistributions in binary form must reproduce the above copyright notice, this list of conditions and the following disclaimer in the documentation and/or other materials provided with the distribution.
- * Neither the name of ScienceLogic, LLC nor the names of its contributors may be used to endorse or promote products derived from this software without specific prior written permission.

THIS SOFTWARE IS PROVIDED BY THE COPYRIGHT HOLDERS AND CONTRIBUTORS
"AS IS" AND ANY EXPRESS OR IMPLIED WARRANTIES, INCLUDING, BUT NOT
LIMITED TO, THE IMPLIED WARRANTIES OF MERCHANTABILITY AND FITNESS FOR
A PARTICULAR PURPOSE ARE DISCLAIMED. IN NO EVENT SHALL THE COPYRIGHT
HOLDERS OR CONTRIBUTORS BE LIABLE FOR ANY DIRECT, INDIRECT,
INCIDENTAL, SPECIAL, EXEMPLARY, OR CONSEQUENTIAL DAMAGES (INCLUDING,
BUT NOT LIMITED TO, PROCUREMENT OF SUBSTITUTE GOODS OR SERVICES; LOSS
OF USE, DATA, OR PROFITS; OR BUSINESS INTERRUPTION) HOWEVER CAUSED AND
ON ANY THEORY OF LIABILITY, WHETHER IN CONTRACT, STRICT LIABILITY, OR
TORT (INCLUDING NEGLIGENCE OR OTHERWISE) ARISING IN ANY WAY OUT OF THE
USE OF THIS SOFTWARE, EVEN IF ADVISED OF THE POSSIBILITY OF SUCH
DAMAGE.

----- Part 10: Lennart Poettering copyright notice (BSD-like) -----

Copyright 2010 Lennart Poettering

Permission is hereby granted, free of charge, to any person
obtaining a copy of this software and associated documentation files

(the "Software"), to deal in the Software without restriction, including without limitation the rights to use, copy, modify, merge, publish, distribute, sublicense, and/or sell copies of the Software, and to permit persons to whom the Software is furnished to do so, subject to the following conditions:

The above copyright notice and this permission notice shall be included in all copies or substantial portions of the Software.

THE SOFTWARE IS PROVIDED "AS IS", WITHOUT WARRANTY OF ANY KIND, EXPRESS OR IMPLIED, INCLUDING BUT NOT LIMITED TO THE WARRANTIES OF MERCHANTABILITY, FITNESS FOR A PARTICULAR PURPOSE AND NONINFRINGEMENT. IN NO EVENT SHALL THE AUTHORS OR COPYRIGHT HOLDERS BE LIABLE FOR ANY CLAIM, DAMAGES OR OTHER LIABILITY, WHETHER IN AN ACTION OF CONTRACT, TORT OR OTHERWISE, ARISING FROM, OUT OF OR IN CONNECTION WITH THE SOFTWARE OR THE USE OR OTHER DEALINGS IN THE SOFTWARE.

----- Part 11: IETF copyright notice (BSD) -----

Copyright (c) 2013 IETF Trust and the persons identified as authors of the code. All rights reserved.

Redistribution and use in source and binary forms, with or without modification, are permitted provided that the following conditions are met:

- * Redistributions of source code must retain the above copyright notice, this list of conditions and the following disclaimer.
- * Redistributions in binary form must reproduce the above copyright notice, this list of conditions and the following disclaimer in the documentation and/or other materials provided with the distribution.
- * Neither the name of Internet Society, IETF or IETF Trust, nor the names of specific contributors, may be used to endorse or promote products derived from this software without specific prior written permission.

THIS SOFTWARE IS PROVIDED BY THE COPYRIGHT HOLDERS AND CONTRIBUTORS "AS IS" AND ANY EXPRESS OR IMPLIED WARRANTIES, INCLUDING, BUT NOT LIMITED TO, THE IMPLIED WARRANTIES OF MERCHANTABILITY AND FITNESS FOR A PARTICULAR PURPOSE ARE DISCLAIMED. IN NO EVENT SHALL THE COPYRIGHT OWNER OR CONTRIBUTORS BE LIABLE FOR ANY DIRECT, INDIRECT, INCIDENTAL, SPECIAL, EXEMPLARY, OR CONSEQUENTIAL DAMAGES (INCLUDING, BUT NOT LIMITED TO, PROCUREMENT OF SUBSTITUTE GOODS OR SERVICES; LOSS OF USE, DATA, OR PROFITS; OR BUSINESS INTERRUPTION) HOWEVER CAUSED AND ON ANY THEORY OF LIABILITY, WHETHER IN CONTRACT, STRICT LIABILITY, OR TORT (INCLUDING NEGLIGENCE OR OTHERWISE) ARISING IN ANY WAY OUT OF THE USE OF THIS SOFTWARE, EVEN IF ADVISED OF THE POSSIBILITY OF SUCH DAMAGE.

----- Part 12: Arista Networks copyright notice (BSD) -----

Copyright (c) 2013, Arista Networks, Inc.
All rights reserved.

Redistribution and use in source and binary forms, with or without modification, are permitted provided that the following conditions are met:

- * Redistributions of source code must retain the above copyright notice, this list of conditions and the following disclaimer.
- * Redistributions in binary form must reproduce the above copyright notice, this list of conditions and the following disclaimer in the documentation and/or other materials provided with the distribution.
- * Neither the name of Arista Networks, Inc. nor the names of its contributors may be used to endorse or promote products derived from this software without specific prior written permission.

THIS SOFTWARE IS PROVIDED BY THE COPYRIGHT HOLDERS AND CONTRIBUTORS "AS IS" AND ANY EXPRESS OR IMPLIED WARRANTIES, INCLUDING, BUT NOT LIMITED TO, THE IMPLIED WARRANTIES OF MERCHANTABILITY AND FITNESS FOR A PARTICULAR PURPOSE ARE DISCLAIMED. IN NO EVENT SHALL THE COPYRIGHT HOLDERS OR CONTRIBUTORS BE LIABLE FOR ANY DIRECT, INDIRECT,

INCIDENTAL, SPECIAL, EXEMPLARY, OR CONSEQUENTIAL DAMAGES (INCLUDING, BUT NOT LIMITED TO, PROCUREMENT OF SUBSTITUTE GOODS OR SERVICES; LOSS OF USE, DATA, OR PROFITS; OR BUSINESS INTERRUPTION) HOWEVER CAUSED AND ON ANY THEORY OF LIABILITY, WHETHER IN CONTRACT, STRICT LIABILITY, OR TORT (INCLUDING NEGLIGENCE OR OTHERWISE) ARISING IN ANY WAY OUT OF THE USE OF THIS SOFTWARE, EVEN IF ADVISED OF THE POSSIBILITY OF SUCH DAMAGE.

----- Part 13: VMware, Inc. copyright notice (BSD) -----

Copyright (c) 2016, VMware, Inc.

All rights reserved.

Redistribution and use in source and binary forms, with or without modification, are permitted provided that the following conditions are met:

- * Redistributions of source code must retain the above copyright notice, this list of conditions and the following disclaimer.
- * Redistributions in binary form must reproduce the above copyright notice, this list of conditions and the following disclaimer in the documentation and/or other materials provided with the distribution.
- * Neither the name of VMware, Inc. nor the names of its contributors may be used to endorse or promote products derived from this software without specific prior written permission.

THIS SOFTWARE IS PROVIDED BY THE COPYRIGHT HOLDERS AND CONTRIBUTORS "AS IS" AND ANY EXPRESS OR IMPLIED WARRANTIES, INCLUDING, BUT NOT LIMITED TO, THE IMPLIED WARRANTIES OF MERCHANTABILITY AND FITNESS FOR A PARTICULAR PURPOSE ARE DISCLAIMED. IN NO EVENT SHALL THE COPYRIGHT HOLDERS OR CONTRIBUTORS BE LIABLE FOR ANY DIRECT, INDIRECT, INCIDENTAL, SPECIAL, EXEMPLARY, OR CONSEQUENTIAL DAMAGES (INCLUDING, BUT NOT LIMITED TO, PROCUREMENT OF SUBSTITUTE GOODS OR SERVICES; LOSS OF USE, DATA, OR PROFITS; OR BUSINESS INTERRUPTION) HOWEVER CAUSED AND ON ANY THEORY OF LIABILITY, WHETHER IN CONTRACT, STRICT LIABILITY, OR TORT (INCLUDING NEGLIGENCE OR OTHERWISE) ARISING IN ANY WAY OUT OF THE USE OF THIS SOFTWARE, EVEN IF ADVISED OF THE POSSIBILITY OF SUCH DAMAGE.

----- Part 14: USC/Information Sciences Institute copyright notice (BSD) -----

Copyright (c) 2017–2018, Information Sciences Institute
All rights reserved.

Redistribution and use in source and binary forms, with or without
modification, are permitted provided that the following conditions are met:

- * Redistributions of source code must retain the above copyright notice,
this list of conditions and the following disclaimer.
- * Redistributions in binary form must reproduce the above copyright
notice, this list of conditions and the following disclaimer in the
documentation and/or other materials provided with the distribution.
- * Neither the name of Information Sciences Institute nor the names of its
contributors may be used to endorse or promote products derived from
this software without specific prior written permission.

THIS SOFTWARE IS PROVIDED BY THE COPYRIGHT HOLDERS AND CONTRIBUTORS "AS IS" AND ANY EXPRESS OR IMPLIED WARRANTIES, INCLUDING, BUT NOT LIMITED TO, THE IMPLIED WARRANTIES OF MERCHANTABILITY AND FITNESS FOR A PARTICULAR PURPOSE ARE DISCLAIMED. IN NO EVENT SHALL THE COPYRIGHT HOLDERS OR CONTRIBUTORS BE LIABLE FOR ANY DIRECT, INDIRECT, INCIDENTAL, SPECIAL, EXEMPLARY, OR CONSEQUENTIAL DAMAGES (INCLUDING, BUT NOT LIMITED TO, PROCUREMENT OF SUBSTITUTE GOODS OR SERVICES; LOSS OF USE, DATA, OR PROFITS; OR BUSINESS INTERRUPTION) HOWEVER CAUSED AND ON ANY THEORY OF LIABILITY, WHETHER IN CONTRACT, STRICT LIABILITY, OR TORT (INCLUDING NEGLIGENCE OR OTHERWISE) ARISING IN ANY WAY OUT OF THE USE OF THIS SOFTWARE, EVEN IF ADVISED OF THE POSSIBILITY OF SUCH DAMAGE.