

HERO 11  
BLACK

## Join the GoPro Movement

---



@GoPro



@GoPro



@GoPro



facebook.com/GoPro



@GoPro



pinterest.com/GoPro

## Contents

---

Meet HERO11 Black	6
Setting Up Your Camera	8
Getting to Know Your GoPro	14
Customizing Your GoPro	29
HERO11 Black Power Tools	39
Using QuikCapture	47
Adding HiLight Tags	48
Setting the Screen Orientation	49
Recording Video	50
Video Settings	58
Taking Photos	61
Photo Settings	68
Capturing Time Lapse	70
Time Lapse Settings	76
Live Streaming + Webcam Mode	79
Exposure Control	80
Controlling Your GoPro With Your Voice	84
Playing Back Your Media	88
Connecting to the GoPro Quik App	92

## Contents

---

Transferring Your Media	94
Setting Your Preferences	99
Important Messages	108
Resetting Your Camera	110
Mounting Your GoPro	112
Removing the Door	117
Maintenance	119
Battery Information	120
Troubleshooting	124
Tech Specs: Video	125
Tech Specs: Photo	137
Tech Specs: Time Lapse	143
Tech Specs: Protune	149
Customer Support	157
Trademarks	157
Regulatory Information	157

## Meet HERO11 Black

---

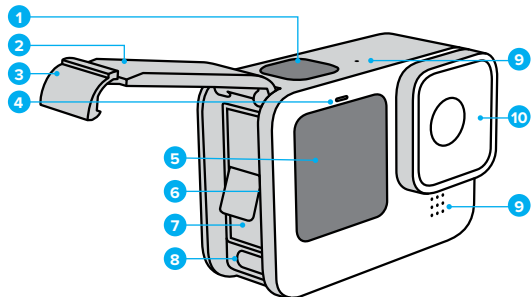



- 1. Shutter Button 
- 2. Door
- 3. Door Latch
- 4. Status Light
- 5. Front Screen

- 6. microSD™ Card Slot
- 7. Battery
- 8. USB-C Port
- 9. Microphone
- 10. Removable Lens

## Meet HERO11 Black

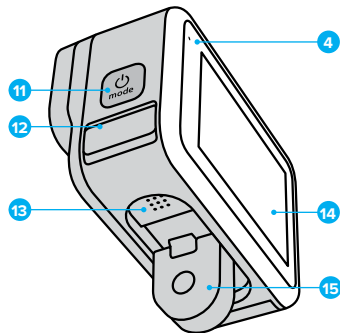
---



- 11. Mode Button 
- 12. Drain Microphone  
(Designed to drain water.  
This is not a door/latch.  
Do not try to open.)

- 13. Speaker
- 14. Touch Screen
- 15. Folding Fingers

Learn how to use the accessories that came with your GoPro.  
See [Mounting Your GoPro \(page 112\)](#).

## Setting Up Your Camera

---

### SD CARDS

You'll need a microSD card (sold separately) to save your videos and photos. Use a brand-name card that fits these requirements:

- microSD, microSDHC™, or microSDXC™
- Rated Class V30, UHS-3, or higher
- Capacity up to 512GB

For a list of recommended microSD cards, visit [gopro.com/microsdcards](https://gopro.com/microsdcards).

Be sure your hands are clean and dry before handling your SD card. Check the manufacturer's guidelines to see your card's acceptable temperature range and other important information.

*Heads Up:* SD cards can degrade over time and affect your camera's ability to save your media. Try swapping out an older card for a new one if you're having any problems.

---

**PRO TIP:** Keep your SD card in good condition by reformatting it regularly. This will erase all of your media, so be sure to save it first.

1. Swipe down on the rear screen to access the Dashboard.
2. Swipe left and tap Preferences > Reset > Format SD Card.

To learn how to save your videos and photos, see [Transferring Your Media \(page 94\)](#).

## Setting Up Your Camera

---

### RECHARGEABLE BATTERY

For maximum performance, be sure to use the Enduro Battery with your new GoPro.

---

**PRO TIP:** There's an easy way to check your battery's status and make sure you're using the right one.

1. Swipe down on the rear screen to access the Dashboard.
2. Swipe left and tap Preferences > About > Battery Info.



**WARNING:** Although non-GoPro batteries may fit in your HERO11 Black, they could greatly limit your camera's performance. Use of non-GoPro batteries will also void your warranty and may cause fire, electric shock, or other safety risks.

---

For more important information on battery safety and use, see [Battery Information \(page 120\)](#).

## Setting Up Your Camera

---

### SD CARD + BATTERY SETUP

1. Unlock the door latch and flip the door open.



2. With your camera off and battery removed, insert the SD card into the card slot with the label facing the battery compartment.

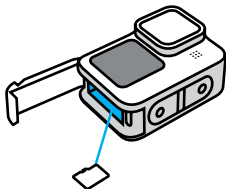

You can eject the card by pressing it into the slot with your fingernail.

## Setting Up Your Camera

---

3. Insert the battery.

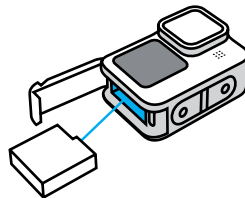

4. Connect your camera to a USB charger or computer using the included USB-C cable.

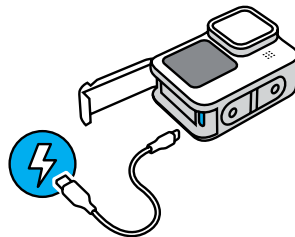

It takes about 3 hours for the battery to fully charge. The camera status light will turn off when it's done. To learn more, see [Battery Information \(page 120\)](#).

**PRO TIP:** For the fastest charging, use the GoPro Supercharger (sold separately).

## Setting Up Your Camera

---

5. Unplug the cable and shut the door when charging is complete. Be sure the door latch is closed and locked before using your camera.

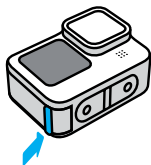

**NOTE:** Your camera's door is removable. Be sure that the door is securely locked and sealed after closing.

## Setting Up Your Camera

---

### UPDATING YOUR CAMERA'S SOFTWARE

To get the latest features and best performance from your GoPro, make sure it's using the most current software.

#### Updating With the GoPro Quik App

1. Download the app from the Apple® App Store® or Google Play™.
2. Follow the app's on-screen instructions to connect your camera to your mobile device. If new camera software is available, the app will tell you how to install it.

#### Updating Manually

1. Visit [gopro.com/update](https://gopro.com/update).
2. Choose HERO11 Black from the list of cameras.
3. Select *Update your camera manually* and follow the instructions.

---

**PRO TIP:** Want to know what software version you're using? Here's where you can find out.

1. Swipe down on the rear screen to access the Dashboard.
2. Swipe left and tap Preferences > About > Camera Info.

## Getting to Know Your GoPro

---

### POWERING ON

Press the Mode button  to turn on your camera.

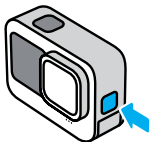

### POWERING OFF

Press and hold the Mode button  for 3 seconds to turn it off.

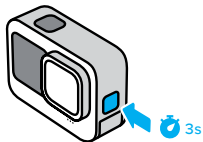

**WARNING:** Use caution when using your GoPro and its mounts and accessories. Always be aware of your surroundings to avoid injuring yourself and others.

Be sure to follow all local laws including all privacy laws, which may restrict recording in certain areas.

---

## Getting to Know Your GoPro

---

### THE FRONT SCREEN

The front LCD screen shows your camera's status, plus a live view from the lens. This makes it easy to capture perfectly framed shots.

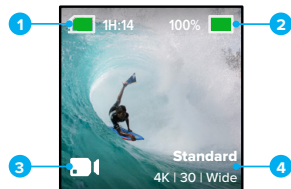

1. Recording Time/Photos Remaining
2. Battery Status
3. Current Mode (Video, Photo, or Time Lapse)
4. Capture Settings







## Getting to Know Your GoPro

---

### Display Options

The front screen features four display options.

1. Swipe down on the rear screen to access the Dashboard.
2. Tap the  to access the front screen settings.
3. Tap the icon of the setting that you want.

Setting	Description
 Full Screen	Displays the live preview as a full-screen shot. The image is cropped for the display, but will be captured without cropping.
 Actual Screen	Displays the live preview from the lens without cropping.
 Status Only	Displays camera status without the live preview from the lens.
 Screen Off	Turns the screen off. Use this setting in dark environments where light from the screen might interfere with your shot. This setting also maximizes battery life.

## Getting to Know Your GoPro

---

### USING THE REAR TOUCH SCREEN

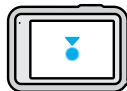

**Tap**  
Select an item to turn it on or off.

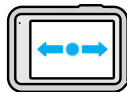

**Swipe Left or Right**  
Switch between Video, Photo, and Time Lapse modes.

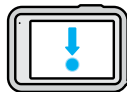

**Swipe Down From the Edge of the Screen**  
Open the Dashboard when your camera is in a landscape orientation.



**Swipe Up From the Edge of the Screen**  
See the last photo or video you captured and access the Media Gallery.



**Press and Hold the Capture Screen**  
Turn on and adjust Exposure Control.

**PRO TIP:** You can hide your camera's status information and icons on both the front and rear screen by tapping the rear screen. Tap the screen again or press a button to bring it all back.

## Getting to Know Your GoPro

---

### GETTING THE SHOT

1. Simply press the Shutter button  to start recording.

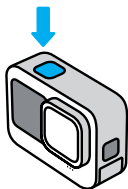

2. Press the Shutter button  again to stop recording (Video, Time Lapse, and Live Streaming only).

## Getting to Know Your GoPro

---

Your GoPro has three main capture modes.

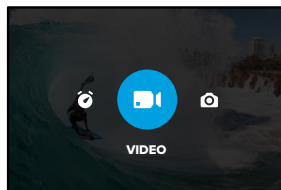

Using the rear touch screen, swipe left or right to the mode you want.

### EASY CONTROLS (DEFAULT)

These simplified controls make it as easy as possible to point, shoot, and get amazing results with your GoPro. Each mode is preloaded with ultra versatile capture settings that are great for most shots.

#### **Video (Default)**

Records 5.3K video at 30 frames per second with the Wide digital lens. Includes onscreen shortcuts that make it easy to swap digital lenses and shoot slo-mo footage.

#### **Photo**

Takes 27MP photos in the 8:7 aspect ratio with the Wide digital lens. Includes onscreen shortcuts for changing digital lenses and setting the photo timer.

#### **Time Lapse**

Captures 4K TimeWarp footage with the Wide digital lens. Includes onscreen shortcut for changing digital lenses and Speed Ramp.

## Getting to Know Your GoPro

---

### PRO CONTROLS

The pro controls unlock your GoPro's preset settings and the ability to take complete control of all modes, settings, and features.

#### Video (Default)

Includes Standard, Full Frame, Activity, Cinematic, and Slo-Mo presets.

To learn more, see [Recording Video \(page 50\)](#).

#### Photo

Includes Photo, Burst, and Night presets.

To learn more, see [Taking Photos \(page 61\)](#).

#### Time Lapse

Includes TimeWarp, Star Trails, Light Painting, Vehicle Light Trails, Time Lapse, and Night Lapse presets.

To learn more, see [Capturing Time Lapse \(page 70\)](#).

*Heads Up:* You can choose which preset will be loaded and ready to go when you turn on your GoPro.

1. Swipe down on the rear screen to access the Dashboard.
2. Swipe left and tap Preferences > General > Default Preset.

---

**PRO TIP:** With the camera on, you can press the Mode button  to switch modes.

### SWITCHING CONTROLS

Your GoPro uses the Easy Controls by default, but you can switch to the Pro Controls with just a couple of swipes and a tap.

1. Swipe down on the rear screen to access the Dashboard.
2. Swipe left and tap Interface to toggle between the Easy and Pro Controls.

## Getting to Know Your GoPro

---

### VIDEO MODES

These modes help you optimize video performance based on how you use your camera.

1. Swipe down on the rear screen to access the Dashboard.
2. Swipe left and tap  to toggle between modes.

#### Highest Quality (Default)

Includes the highest quality video resolutions and frame rates for the best possible video and ultra slo-mo footage.

To learn more, see [Highest Quality Video Mode \(page 130\)](#).

#### Extended Battery

Uses mid-range quality video resolutions and frame rates to help you capture stunning footage while extending battery life.

To learn more, see [Extended Battery Settings \(page 132\)](#).

---

**PRO TIP:** Use the Standard preset in Extended Battery mode .

## Getting to Know Your GoPro

### THE TOUCH SCREEN

The rear touch screen gives you access to your camera's capture settings.

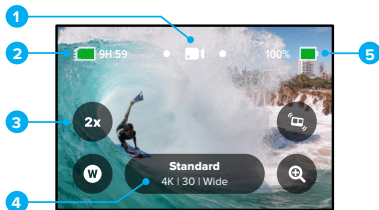

1. Current Mode (Video, Photo, or Time Lapse)
2. Recording Time/Photos Remaining
3. Customizable On-Screen Shortcuts
4. Capture Settings
5. Battery Status

*Heads Up:* The capture settings are not available when you turn your GoPro to take portrait shots. Be sure to choose the settings you want before rotating your camera.

**PRO TIP:** Press the Mode button  to quickly jump back to this screen from almost anywhere.

## Getting to Know Your GoPro

### CHANGING PRESETS

Each capture mode has presets that make it easy to switch back and forth between the best mode and settings for your shot.

1. Tap the capture settings.

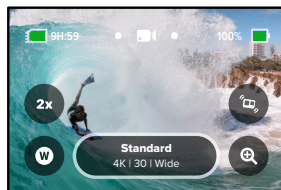

2. Tap the preset that you want. All of the preset's settings will be locked into your camera and ready to go.

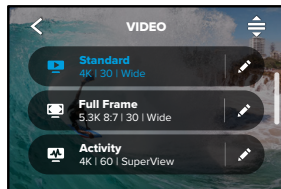

## Getting to Know Your GoPro

### CUSTOMIZING THE PRESETS

You can change the settings in your presets with just a few taps.

1. From the capture screen, you can press and hold the capture settings to skip straight to the settings menu.

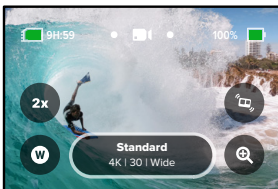

2. Tap the setting that you want to change.

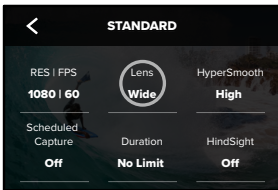

## Getting to Know Your GoPro

The on-screen instructions will give you a rundown of your options.

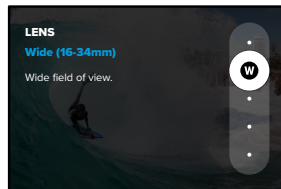

For details on settings, see [Tech Specs](#) (starting page 125).

3. Scroll down for the more advanced settings.

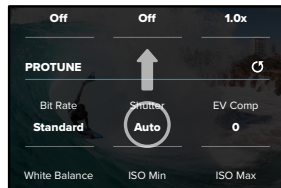

For details on all advanced settings, see [Protune](#) (starting page 149).

## Getting to Know Your GoPro

---

4. Tap  to save your changes and return to the presets screen.

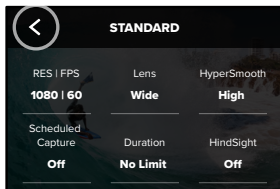

*Heads Up:* You can't delete the preloaded presets, but you can customize them any way you want. You can also create your own custom presets.

To learn more, see [Creating Your Own Presets \(page 29\)](#).

---

**PRO TIP:** You can also get to the settings menu by tapping  next to the preset you want to adjust.

## Getting to Know Your GoPro

---

### RESTORING PRESETS TO THEIR ORIGINAL SETTINGS

You can go back to your presets' original settings anytime.

1. Tap .



2. Tap .

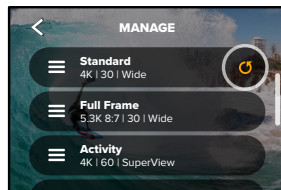

3. Tap Done.



*Heads Up:* You can also scroll to the end of the list of settings and tap Restore.

## Getting to Know Your GoPro

---

### NAVIGATING WITH THE BUTTONS

Although your GoPro is waterproof, the touch screen won't work under water. Use the buttons and front screen to swap modes and presets.

1. With the camera on, you can press the Mode button  to switch modes.
2. Hold down the Mode button and press the Shutter button . A menu will appear on the front screen.
3. Press the Mode button to scroll through the presets.
4. Use the Shutter button to select a preset.

*Heads Up:* The Dashboard and Media Gallery are not available when navigating with the buttons.

## Customizing Your GoPro

---

### CREATING YOUR OWN PRESETS

The perfect capture settings for a day out on the slopes may not be so great when you're recording indoors. Custom presets let you set up and save settings for both so you can switch back and forth in no time.

1. Tap the capture settings, and then tap  in the upper right corner.

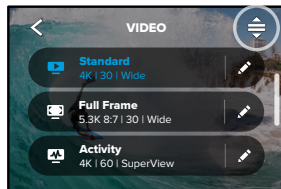

2. Tap  in the upper right corner.

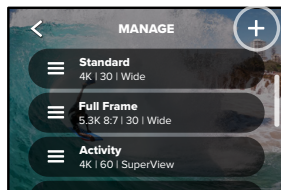

## Customizing Your GoPro

3. Choose a preset mode.

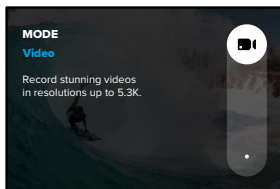

Tap a setting to change it.

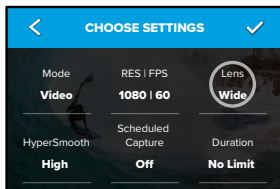

The on-screen instructions will give you a rundown of your options.  
For details on all settings, see [Tech Specs \(starting page 125\)](#).

## Customizing Your GoPro

4. Scroll down for the more advanced settings.

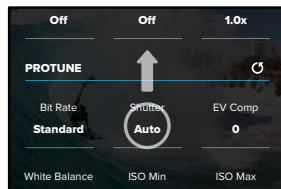

For details on advanced settings, see [Protune \(starting page 149\)](#).

5. Tap ✓ when you're finished.

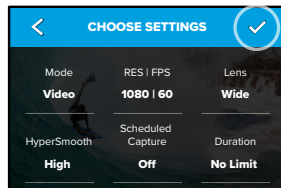



## Customizing Your GoPro

6. Choose an icon and name for your preset.

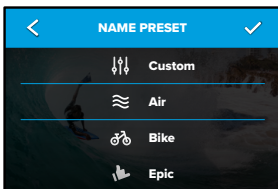

7. Tap ✓ to save your preset.

You may need to fine-tune your presets after trying them out.

Tap  next to the preset to make adjustments.

## Customizing Your GoPro

### DELETING YOUR PRESET

1. Tap .

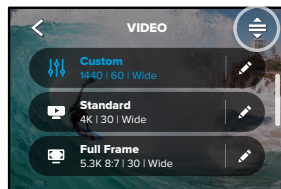

2. Tap .

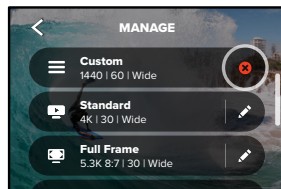

*Heads Up:* You can also scroll to the end of the list of settings and tap Delete.

## Customizing Your GoPro

---

### SUGGESTED SETTINGS

Here are some of the best modes and settings for capturing your favorite activities. Try them as starting points for your presets, and then experiment to find what works best for you.

Activity	Video	Photo
Air	<ul style="list-style-type: none"><li>• 4K60, Wide Lens</li><li>• 1080p120, Wide Lens</li><li>• 15x TimeWarp Video</li></ul>	<ul style="list-style-type: none"><li>• Time Lapse Photo (1-second interval) 1080p120, Wide Lens</li><li>• Burst (30/3 Rate), Wide Lens</li></ul>
Bike	<ul style="list-style-type: none"><li>• 5.3K30 8:7, Wide Lens</li><li>• 4K30 4:3, Wide Lens</li><li>• 2.7K60 4:3, Wide Lens</li><li>• 15x TimeWarp Video</li></ul>	<ul style="list-style-type: none"><li>• Time Lapse Photo (5-second interval), Wide Lens</li></ul>
Indoor	<ul style="list-style-type: none"><li>• 4K30 4:3, Wide Lens</li><li>• 1080p30, Wide Lens</li></ul>	<ul style="list-style-type: none"><li>• Photo, Wide Lens</li></ul>
Motor	<ul style="list-style-type: none"><li>• 4K30 4:3, Wide Lens</li><li>• 2.7K60 4:3, Wide Lens</li><li>• 15x TimeWarp Video</li></ul>	<ul style="list-style-type: none"><li>• Time Lapse Photo (5-second interval), Wide Lens</li></ul>
Mounted	<ul style="list-style-type: none"><li>• 5.3K30, Wide Lens</li><li>• 4K60 4:3, Wide Lens</li><li>• Auto TimeWarp Video</li></ul>	<ul style="list-style-type: none"><li>• Time Lapse Photo (5-second interval), Wide Lens</li></ul>
Outdoor	<ul style="list-style-type: none"><li>• 5.3K30, Wide Lens</li><li>• 4K60 4:3, Wide Lens</li><li>• 10x TimeWarp Video</li></ul>	<ul style="list-style-type: none"><li>• Photo, Wide Lens</li></ul>

## Customizing Your GoPro

---

Activity	Video	Photo
POV*	<ul style="list-style-type: none"><li>• 4K60 4:3, Wide Lens</li><li>• 4K120 4:3, Wide Lens</li><li>• 15x TimeWarp Video</li></ul>	<ul style="list-style-type: none"><li>• Time Lapse Photo (2-second interval), Wide Lens</li><li>• Burst (30/3 Rate), Wide Lens</li></ul>
Selfie	<ul style="list-style-type: none"><li>• 4K30 4:3, Narrow Lens</li><li>• 4K60 4:3, Wide Lens</li></ul>	<ul style="list-style-type: none"><li>• Photo, Narrow Lens, SuperPhoto, Photo Timer</li></ul>
Snow	<ul style="list-style-type: none"><li>• 4K60, Wide Lens</li><li>• 1080p120, Wide Lens</li><li>• 15x TimeWarp Video</li></ul>	<ul style="list-style-type: none"><li>• Time Lapse Photo (1-second interval), Wide Lens</li><li>• Burst (30/3 Rate), Wide Lens</li></ul>
Trail	<ul style="list-style-type: none"><li>• 4K30 4:3, Wide Lens</li><li>• 4K60 4:3, Wide Lens</li><li>• 15x TimeWarp Video</li></ul>	<ul style="list-style-type: none"><li>• Photo, Wide Lens</li></ul>
Travel	<ul style="list-style-type: none"><li>• 5.3K30, Wide Lens</li><li>• 4K60 4:3, Wide Lens</li><li>• 10x TimeWarp Video</li></ul>	<ul style="list-style-type: none"><li>• Photo, Wide Lens</li></ul>
Water	<ul style="list-style-type: none"><li>• 4K60, Wide Lens</li><li>• 1080p240, Wide Lens</li></ul>	<ul style="list-style-type: none"><li>• Time Lapse Photo (2- or 5-second interval), Wide Lens</li><li>• Burst (30/6 Rate), Wide Lens</li></ul>

\*Point-of-view (POV) shots are those taken from your point of view using a body mount or handheld mount.

## Customizing Your GoPro

### PERSONALIZING YOUR ON-SCREEN SHORTCUTS

On-screen shortcuts give you quick one-tap access to your camera's capture settings. Each mode has its own default shortcuts, but you can change them to the settings that you use most. You can even set up different shortcuts for each preset.

1. Tap the  next to the preset you want to adjust.

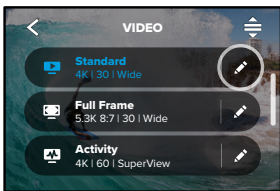

2. Scroll down to the On-Screen Shortcuts.

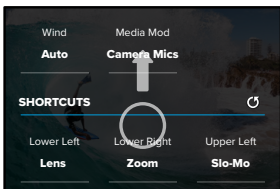

## Customizing Your GoPro

3. Tap where you'd like to put your new shortcut.

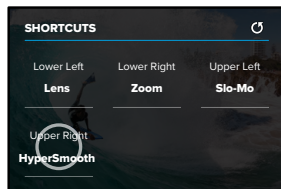

4. Scroll through all of the available shortcuts on the right and choose the one you want.

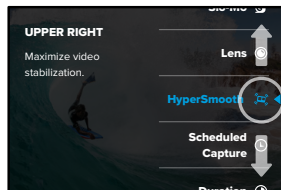

For details on shortcuts, see [Tech Specs \(starting page 125\)](#) and [Protune \(starting page 149\)](#).

## Customizing Your GoPro

5. Tap  to save your changes and return to the presets screen.

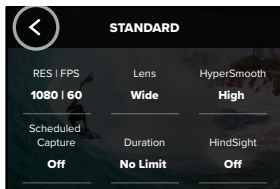

Now you can simply tap the shortcut to change settings.

## HERO11 Black Power Tools

Your GoPro comes with Power Tools—a full suite of smart capture settings that extend the capture options beyond simply pressing the shutter button.

### HINDSIGHT

HindSight is a powerful feature that can capture up to 30 seconds of video before you press the Shutter button. This lets you record key moments even after they happen.

#### Using HindSight

Imagine your kid making the game-winning play during their big game. This is a moment you don't want to miss. With HindSight on, you can frame your shot, but you don't have to start recording. You can press the Shutter button  after they make the big play. HindSight will save the video it captured before you pressed the Shutter button (up to 30 seconds) and will continue recording until you stop the video.

#### Setting Up HindSight

1. After choosing a video preset, press and hold the capture settings to go to the settings menu.

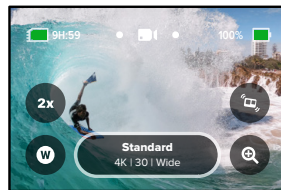

## HERO11 Black Power Tools

---

2. Tap HindSight.

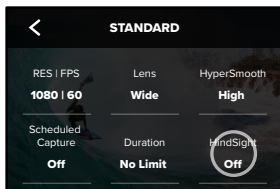

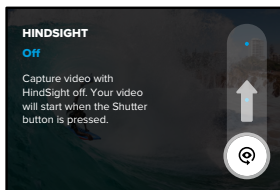

3. Set HindSight for either 15 or 30 seconds.



## HERO11 Black Power Tools

---

The  on the rear touch screen will let you know that HindSight is on. Press the Shutter button  at any time to start recording.

The indicator at the top center of the screen will turn blue when the HindSight buffer is full. That means that your camera is storing the previous 15 or 30 seconds of video. It will only save the video if you press the Shutter button  to start recording.

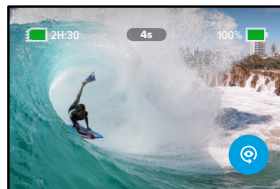

*Heads Up:* Make sure that you've locked in the capture settings you want before starting HindSight. You won't be able to change settings once HindSight is on.

## HERO11 Black Power Tools

You can also tap Stop HindSight at any time to cancel HindSight and save battery power.



Your camera will also pause HindSight if you have not started recording 15 minutes after you turned HindSight on. This is another way to conserve battery power.

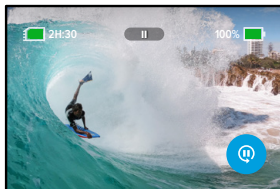

**Heads Up:** HindSight works by capturing video the entire time that it's on (even when you're not actively recording). Depending on how you use it, HindSight may use your camera's battery capacity faster than recording in normal video mode.

## HERO11 Black Power Tools

### SCHEDULED CAPTURE

Scheduled capture lets you set your GoPro to automatically turn itself on and capture a shot up to 24 hours in advance. It's available for all presets.

### Setting Up Scheduled Capture

1. Press and hold the capture settings on the capture screen to go to the settings menu.

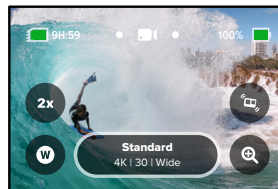

2. Tap Scheduled Capture.

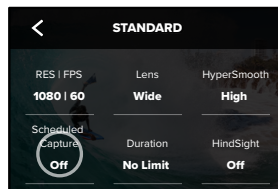

## HERO11 Black Power Tools

3. Set when you want your GoPro to capture the shot.

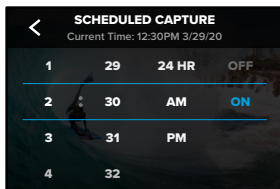

4. After setting the time, you can turn your GoPro off or continue using your camera's other presets.

*Heads Up:* Your GoPro will stay on after taking the shot. It will turn itself off after idling for the length of time set in Preferences.

1. Swipe down on the rear screen to access the Dashboard.
2. Swipe left and tap Preferences > General > Auto Power Off.

**PRO TIP:** Use duration capture to choose the shot length when using scheduled capture. Your camera will automatically stop recording after it gets the shot. You'll have to press the Shutter button  to stop recording if you're not using duration capture.

## HERO11 Black Power Tools

### DURATION CAPTURE

Use duration capture to set how long your GoPro records before it stops. It's available in Video, TimeWarp, Time Lapse, and Night Lapse modes in increments from 15 seconds to 3 hours.

### Setting Up Duration Capture

1. Press and hold the capture settings on the capture screen to go to the settings menu.

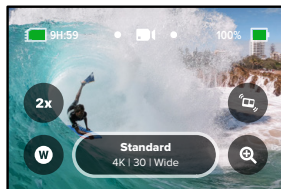

2. Tap Duration.

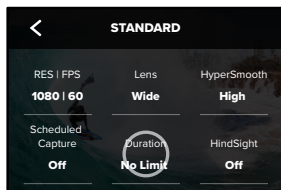

## HERO11 Black Power Tools

---

3. Choose the duration for your shot.

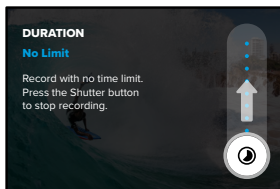

4. Press the Shutter button  to start recording. Your GoPro will automatically stop after recording for the set duration.

*Heads Up:* Duration capture sets how long your GoPro will record. The length of your final video will vary based on the mode you're using. TimeWarp and time lapse videos will be shorter than the set duration.

---

**PRO TIP:** Choose No Limit to capture footage without a time limit. Press the Shutter button  to stop recording.

## Using QuikCapture

---

QuikCapture is the fastest and easiest way to power on your GoPro and get the shot. All it takes is the push of the Shutter button.

### RECORDING VIDEO WITH QUIKCATURE

1. With your camera off, press the Shutter button .

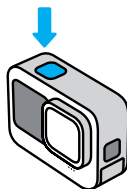

2. Press the Shutter button  again to stop recording and turn off your camera.

*Heads Up:* When using QuikCapture, your camera will start recording with the video settings that you used last.

For more Video options, see [Recording Video \(page 50\)](#).

### TURNING OFF QUIKCATURE

QuikCapture is on by default, but you can turn it off.

1. Swipe down on the rear screen to access the Dashboard.
2. Tap .



---

**PRO TIP:** Since it only turns the camera on when it's recording, QuikCapture is a great way to maximize battery life.



## Adding HiLight Tags

---

Mark favorite moments in your videos and photos by pressing the Mode button  during recording or playback. This adds a HiLight Tag  that makes those moments easier to find when you're watching your footage, creating a video, or looking for a certain shot.

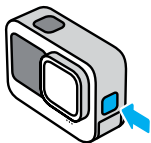

You can also add HiLight Tags by saying, "GoPro, HiLight" when Voice Control is on and by tapping  when watching your footage with the GoPro Quik app.

---

**PRO TIP:** The Quik app looks for HiLight Tags when it creates videos. This helps to ensure that favorite moments are included in your stories.

## Setting the Screen Orientation

---

You can easily switch between landscape and portrait shots by rotating your camera. It can even capture photos and videos right-side up when it's mounted upside down.

The orientation is locked in when you press the Shutter button . If your camera tilts during recording, like on a roller coaster, your footage will tilt with it. You'll capture every twist and turn.

### LOCKING THE ORIENTATION

You can lock the screen in landscape or portrait orientation. This is especially useful when you're using body and handheld mounts. That's when accidentally shooting in the wrong orientation is most likely to happen.

Swipe down on the rear screen to access the Dashboard.

1. Turn your camera to the orientation you want.
2. Tap  on the Dashboard.

The screen is now locked and will match the orientation of your camera.

*Heads Up:* Locking the screen in this way will only work when the Orientation is set to All (default) in Preferences.

### SETTING LANDSCAPE LOCK

You can also set your GoPro to record only in landscape orientation.

Swipe down on the rear screen to access the Dashboard.

1. Swipe left and tap Preferences > Displays > Orientation.
2. Switch from Auto (default) to Landscape.

Your GoPro will record right-side up whether your camera is right-side up or upside down. You can also lock the orientation on the Dashboard.

## Recording Video

---

Your GoPro comes loaded with five video presets. Once you've chosen your preset, press the Shutter button  to start recording.

### STANDARD (DEFAULT)

A versatile preset that's great for all-purpose recording. It shoots 5.3K video (1080p in Extended Battery mode) at 30 frames per second (fps) for full-screen playback on your phone and TV. The digital lens is set to Wide to capture more of the scene in the frame.

### FULL FRAME (HIGHEST QUALITY MODE ONLY)

This preset captures 5.3K video in the ultra immersive 8:7 aspect ratio at 30 fps with the Wide digital lens. The extra height and width in each shot makes it perfect for creating extra-tall 9:16 vertical shots or any other size you need for any social media platform with less cropping.

### ACTIVITY

Use this preset to capture ultra immersive footage of your favorite activities. It records 4K video (2.7K in Extended Battery mode) at 60 fps with the SuperView digital lens. This gives your video the classic GoPro look with high-resolution, full-screen playback.

### CINEMATIC

Captures stunning 5.3K high-resolution video (4K in Extended Battery Mode) at 30 fps. This preset uses the Linear digital lens (with Horizon Lock in Highest Quality mode) to smooth out the fish-eye effect and give your footage a dramatic cinematic feel.

### SLO-MO

Great for fast-action shots, this preset records 2.7K footage at 240 fps (1080p at 240 fps in Extended Battery Mode) with the Wide lens. This lets you slow things down to 8x normal speed during playback and catch amazing details you can't see with the naked eye.

## Recording Video

---

### ON-SCREEN SHORTCUTS

The video presets feature four default shortcuts, but you can swap them out with any shortcuts you'd like.

To learn more, see [Personalizing Your On-Screen Shortcuts \(page 36\)](#).

### Slo-Mo

Tap the Slo-Mo shortcut to change the recording speed of your video.

1. Tap **2x** before you start recording.

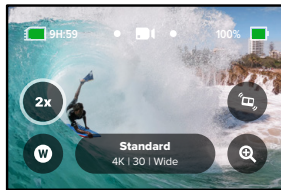

## Recording Video

---

- Use the slider to choose 1x (at 24 or 30 frames per second), 2x, 4x, or 8x slow motion.



*Heads Up:* Available speeds will vary based on the resolution and digital lens selected. Slo-Mo is unavailable when recording in 5K 4:3.

- Press the Shutter button  to start recording.

**PRO TIP:** Any video recorded in Slo-Mo can be played back in slow motion or normal speed.

## Recording Video

---

### Digital Lenses

Changing digital lenses on your GoPro is just like switching out the lenses on an old-school camera. They affect the field of view, the cropping, and the fisheye effect in your shot.

- Tap .

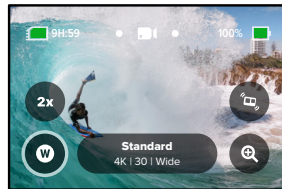

## Recording Video

---

2. Scroll through the options to see a live preview of each option, and then tap the one that you want.



*Heads Up:* Some digital lenses only work with select frame rates. If needed, your GoPro will automatically adjust the frame rate when you switch lenses.

---

**PRO TIP:** Use the Linear + Horizon Lock and Linear + Horizon Leveling digital lenses to give your videos the cinematic look of professional productions by keeping the horizon straight and level.

To learn more, see [Horizon Lock / Horizon Leveling](#) (starting page 133).

## Recording Video

---

### HyperSmooth

The HyperSmooth shortcut lets you quickly choose your level of video stabilization.

1. Tap  before you start recording.

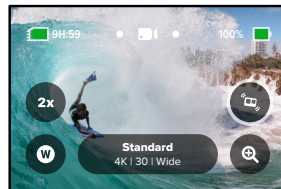

2. Use the slider to choose HyperSmooth Off, On, Boost, or AutoBoost.

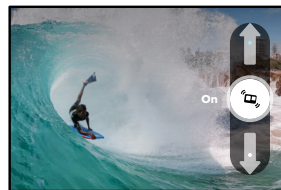

To learn more, see [HyperSmooth Video Stabilization](#) (page 136).

## Recording Video

*Heads Up:* HyperSmooth options may vary based on the video resolution and frame rate selected.

**PRO TIP:** HyperSmooth Boost provides ultimate video stabilization by tightly cropping the image. Turn HyperSmooth off for uncropped, unstabilized footage, or use the On or AutoBoost settings for stabilized video with a wider field of view.

### Touch Zoom

Touch Zoom helps you capture a closer view of the action.

1. Tap .

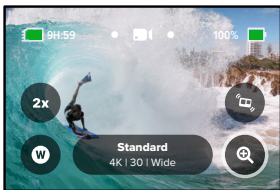

## Recording Video

2. Use the slider to choose how much you want to zoom.

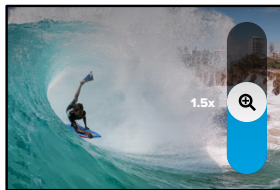



3. The zoom level is locked until you readjust it, switch capture modes, or turn off your camera.

### LOOPING VIDEO



Looping lets you save space on your SD card by recording in a continuous loop until you've captured the moment you want. Use it when you're waiting for something to happen (like fishing) or when nothing may happen (like a dashcam).

Here's how it works:

- If you select 5-minute intervals, only the previous 5 minutes are saved when you press the Shutter button  to stop recording.
- If you record for 5 minutes and don't press the Shutter button , your camera will loop back and record over the start of the video.

### Set Up Looping Video

To capture Looping video, you'll need to set up a new preset.

1. Tap the video capture settings, and then tap  in the upper right corner.
2. Tap  in the upper right corner.
3. Tap Looping and choose the settings you want for your video.

## Video Settings

Here's a breakdown of the video settings. Tap the  and then the setting to make changes.

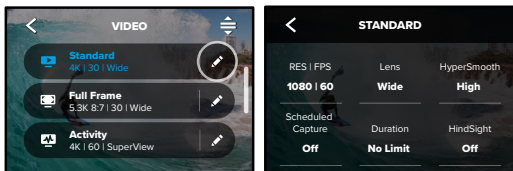

### RES | FPS

This is where you can choose the aspect ratio, resolution (Res), and frame rate (also called frames per second or fps) for your videos. Aspect ratios are listed across the top row. Resolutions are in the middle row. Frame rates are at the bottom of the screen.

Tap any setting that you want for your video. Your camera will select the best available compatible settings. For example, if you tap the 16:9 aspect ratio, your camera will automatically choose 5.3K video at a frame rate of 60 fps. These will be highlighted in blue and displayed at the center of the screen. Simply tap another resolution or frame rate to make changes.

*Heads Up:* Available settings will vary based on the aspect ratio, resolution, and frame rate selected. Compatible settings are shown in blue or white. Non-compatible settings are shown in gray.

To learn more, see:

- [Video Resolution \(page 144\)](#)
- [Frames per Second \(FPS\) \(page 127\)](#)
- [Aspect Ratio \(Video\) \(page 128\)](#)

## Video Settings

### LENS

Choose the best digital lens for your shot—HyperView, SuperView, Wide, Linear + Horizon Lock/Leveling, or Linear. The default lens will vary based on the preset. Heads Up: Available lenses will vary based on the resolution and frame rate you select.

To learn more, see [Digital Lenses \(Video\) \(page 129\)](#).

### INTERVAL (LOOPING)

Choose how long your GoPro records before looping back to record over the start of the video. The default interval is 5 minutes.

To learn more, see [Looping Interval \(page 136\)](#).

### HYPERSMOOTH

Perfect for biking, skiing, handheld shots, and more, HyperSmooth video stabilization delivers insanely smooth, gimbal-like footage without the gimbal. The available settings are Off, On, Boost, and AutoBoost.

To learn more, see [HyperSmooth Video Stabilization \(page 136\)](#).

### SCHEDULED CAPTURE

Set when your GoPro will turn itself on and start recording.

### DURATION

Choose how long your camera records before automatically stopping.

### HINDSIGHT

Choose whether HindSight saves 15 or 30 seconds of video before you press the Shutter button .

## Video Settings

---

### TIMER

Set up a 3- or 10-second timer for your video.

### TOUCH ZOOM

Touch Zoom helps you capture a closer view of the action. Use the slider on the right to lock in the zoom level.

### PROTUNE

Protune gives you manual control of advanced settings, including Bit Rate, Color, ISO Limit, Exposure, and microphone settings.

To learn more, see [Protune \(page 149\)](#).

## Taking Photos

---

Your GoPro has three Photo presets. Simply choose the type of photo you want and press the Shutter button  to get the shot. All photos are captured at 27MP using the ultra versatile 8:7 aspect ratio that's great for social media. The default digital lens on all three presets is set to Wide.

To learn more, see [Aspect Ratio \(Video\) \(page 128\)](#).

### PHOTO (DEFAULT)

Use this preset to capture photos with SuperPhoto image processing. A single press of the Shutter button  will capture a single photo.

### BURST

Burst captures a series of photos at blistering rates. This makes it perfect for fast-action shots. This preset automatically shoots up to 30 photos in 1 second based on lighting conditions.

### NIGHT

The Night preset automatically adjusts your camera's shutter speed to let in more light for your shot. It's perfect for dim or dark scenes, but it's not recommended for handheld or mounted shots when the camera is moving.

## Taking Photos

---

### ON-SCREEN SHORTCUTS

The photo presets feature four default shortcuts, but you can swap them out with any shortcuts you'd like.

To learn more, see [Personalizing Your On-Screen Shortcuts \(page 36\)](#).

*Heads Up:* Output is only a default shortcut for the Photo preset, but you can also set it up in Burst and Night modes.

### Photo Timer

Use the Timer to set up a selfie, group shot, and more.

1. Tap .

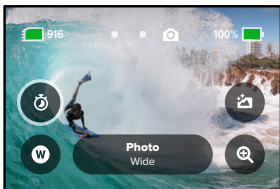

## Taking Photos

---

1. Choose 3 seconds (great for selfies) or 10 seconds (great for group shots).

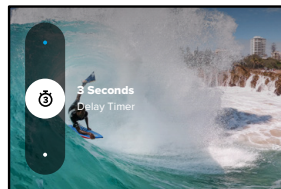

2. Press the Shutter button . Your camera will start the countdown. It will also beep, and the front status light will blink. Both will speed up as the time winds down before snapping the photo.

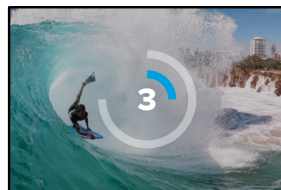

*Heads Up:* To help prevent blurry low-light shots, the timer is automatically set to 3 seconds when you switch to Night photo mode.



## Taking Photos

---

### Digital Lenses

Digital lenses affect the field of view, the cropping, and the fisheye effect in your photo. Switch them up to see what works best for your shot.

1. Tap **W**.

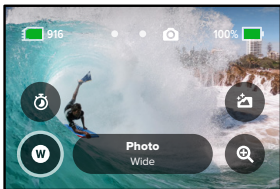

2. Scroll through the options to see a live preview of each option, and then tap the one that you want.

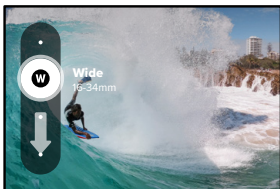

## Taking Photos

---

### Output

Your GoPro lets you decide how your photos are processed and saved. Photo mode (shooting one photo at a time) gives you the most options.

Output	Mode	Description
SuperPhoto (Default)	Photo	Automatically uses advanced image processing to give you the most brilliant photos possible in any lighting. May take longer to process each shot.
HDR	Photo	Takes and combines multiple photos into a single shot. Brings out the details in scenes that mix bright light and shadows.
Standard	Photo, Burst, Night	Saves photos as standard .jpg files.
RAW	Photo, Burst, Night	Saves each photo as .jpg and .gpr files for use with your favorite photo editing programs.

## Taking Photos

---

1. Tap .

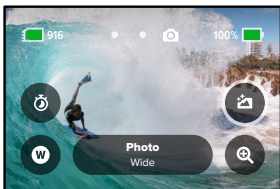

2. Scroll through the options on the right, and then tap the one that you want.

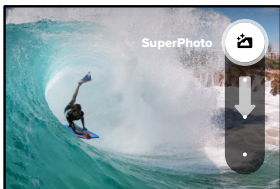

## Taking Photos

---

### Touch Zoom

Touch Zoom helps you capture a closer view of the action.

1. Tap .

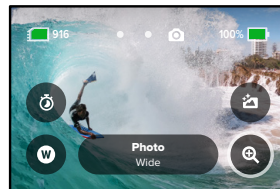

2. Use the slider to choose how much you want to zoom.



3. The zoom level is locked until you readjust it, switch capture modes, or turn off your camera.

---

**PRO TIP:** You can set up your shot using any combination of Burst, Photo Timer, and Zoom.

## Photo Settings

---

Here's an overview of the available photo settings. Tap the  to access the settings menu, and then tap the setting itself to make changes.

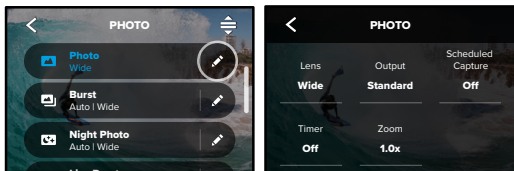

### LENS

Choose best digital lens for your shot—Wide or Linear. Scroll through them on the right side to see a live preview of each, and then tap the one you want.

To learn more, see [Digital Lenses \(Photo\) \(starting page 141\)](#).

### OUTPUT (PHOTO, BURST, NIGHT)

Set the level of processing for your shot and how the files are saved. Choose SuperPhoto, HDR, Standard, or RAW Format.

To learn more, see:

- [SuperPhoto \(page 138\)](#)
- [High Dynamic Range \(HDR\) \(starting page 138\)](#)
- [RAW Format \(starting page 142\)](#)

### SCHEDULED CAPTURE

Set when your GoPro will turn itself on and take a photo.

## Photo Settings

---

### TIMER

Set up a 3- or 10-second timer for your photo.

### ZOOM

Touch Zoom helps you capture a closer view of the action. Use the slider on the right to lock in the zoom level.

### SHUTTER (NIGHT)

Set how long your camera's shutter stays open for night shots. Choose longer exposures for darker shots.

To learn more, see [Shutter Speed \(page 140\)](#).

### BURST RATE (BURST)

Choose how many photos your camera will take in a 1, 3, 6, or 10 second burst.

To learn more, see [Burst Rate \(page 140\)](#).

### PROTUNE (PHOTO, BURST, NIGHT)

Protune gives you manual control of advanced settings including Shutter, Bit Rate, Color, ISO Limit, and Exposure.

To learn more, see [Protune \(starting page 149\)](#).

## Capturing Time Lapse

---

Time Lapse turns long events into short, shareable videos by taking a frame of video at set intervals. Your GoPro has six Time Lapse presets. All you have to do is press the Shutter button  to start recording, and then press it again to stop.

### TIMEWARP (DEFAULT)

HERO11 Black lets you speed up time by using TimeWarp video stabilization to capture ultra smooth time lapse video while you're on the move. This preset captures 4K video with the Wide digital lens while automatically adjusting your capture speed for the best results.

Tap the screen during recording to activate Speed Ramp. This slows down your TimeWarp to real speed or half speed. Tap the screen again to speed back up.

---

**PRO TIP:** You can also use the Mode button  to activate Speed Ramp. Scroll down to Shortcuts in the setting menu to set it up.

### STAR TRAILS

Mount your camera to a stationary object or tripod, point it toward the night sky, and let physics take over. Star Trails uses the Earth's rotation and the stars to create beautiful trails of light across the sky. Use the trail length effect to choose maximum, long, or short trail lengths.

### LIGHT PAINTING

Light Painting uses a long exposure to let you create brilliant brush stroke effects with moving light. Mount your camera to a stationary object or tripod, grab a flashlight, glow stick, or other light source, and get creative.

## Capturing Time Lapse

---

### VEHICLE LIGHT TRAILS

Mount your camera to a stationary object or tripod and point your camera at moving vehicles to create stunning light trail footage. Be sure to use the trail length effect to choose maximum, long, or short trail lengths.

### TIME LAPSE

Use this preset to capture time lapse video when your camera is mounted and still. It's great for sunsets, street scenes, art projects, and other shots that unfold over a long period of time. It records 4K video with the Wide digital lens while capturing a shot every 0.5 seconds.

### NIGHT LAPSE

Night Lapse was made to capture time lapse video in dark and low-light environments. It automatically adjusts the shutter speed to let in more light and picks the interval that will give you the best results. It records 4K video with the Wide digital lens. Night Lapse isn't recommended for handheld or mounted shots when the camera is moving.

---

**PRO TIP:** HERO11 Black can also capture Time Lapse and Night Lapse photos. Simply go to Format in settings and chose Photo.

## Capturing Time Lapse

---

### ON-SCREEN SHORTCUTS

The Time Lapse presets include two default shortcuts, but you can swap them out with any shortcuts you'd like.

To learn more, see [Personalizing Your On-Screen Shortcuts \(page 36\)](#).

---

**PRO TIP:** Although there are only two default shortcuts, you can have up to four.

### Digital Lenses

Swap out digital lenses to change the field of view, the cropping, and the fisheye effect in your shot.

1. Tap **W**.

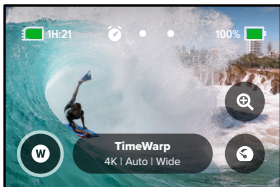

## Capturing Time Lapse

---

2. Scroll through the options to see a live preview of each option, and then tap the one that you want.

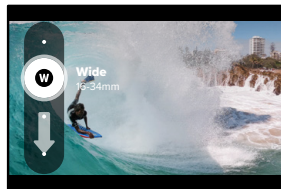

*Heads Up:* Available lenses will vary based on the mode you select.

## Capturing Time Lapse

### Touch Zoom

Touch Zoom helps you capture a closer view of the action.

1. Tap .

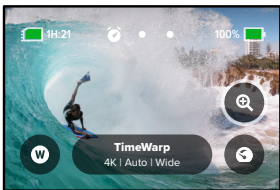

2. Use the slider to choose how much you want to zoom.

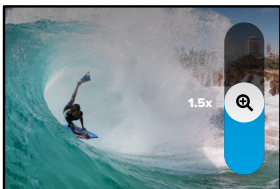

3. The zoom level is locked until you readjust it, switch capture modes, or turn off your camera.

## Capturing Time Lapse

### Speed Ramp (TimeWarp)

Set Speed Ramp to slow your TimeWarp video down to 1x real speed (30 fps) or 0.5x half speed (60 fps).

*Heads Up:* Half speed is available when shooting 1080p footage.

1. Tap  to switch Speed Ramp from real speed (default) to half speed.

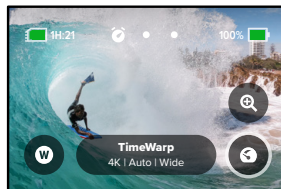

2. Tap the screen while recording to slow down your video. Tap again to speed back up.

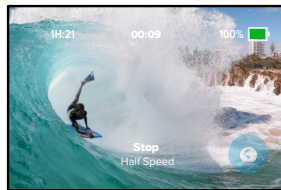

## Time Lapse Settings

---

Here's where you can make adjustments to your Time Lapse settings.

Tap the  and then tap the setting to make changes.

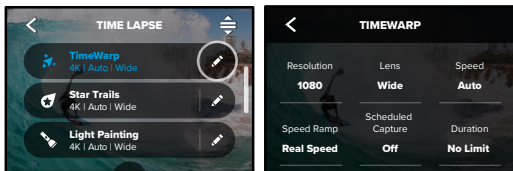

### RESOLUTION

Resolutions (RES) are grouped by aspect ratio. Tall 4:3 resolutions (great for selfies and point-of-view shots) are listed in the top row. Widescreen 16:9 resolutions (great for cinematic shots) are in the bottom row.

To learn more, see:

- [Video Resolution \(TimeWarp, Time Lapse Video\) \(page 144\)](#)
- [Aspect Ratio \(Video\) \(page 128\)](#)

### LENS

Choose the best digital lens for your shot—Wide or Linear. Scroll through them on the right side to see a live preview of each, and then tap the one you want.

*Heads Up:* Available lenses will vary based on the mode you select.

To learn more, see [Digital Lenses \(Photo\) \(page 141\)](#).

## Time Lapse Settings

---

### SCHEDULED CAPTURE

Set when your GoPro will turn itself on and start recording.

### DURATION

Choose how long your camera records before automatically stopping.

### TIMER

Set up a 3- or 10-second timer for your time lapse.

### ZOOM

Touch Zoom helps you capture a closer view of the action. Use the slider on the right to lock in the zoom level.

### SPEED (TIMEWARP)

Set your video speed. Choose a lower speed (2x or 5x) for short activities or higher speeds (10x, 15x, or 30x) for longer activities. Leave speed on Auto (default) to let your GoPro automatically adjust the speed based on motion, scene detection, and lighting.

To learn more, see [TimeWarp Video Speed \(page 143\)](#).

### SPEED RAMP (TIMEWARP)

Choose to slow your TimeWarp video down to real speed or half speed while recording.

To learn more, see [TimeWarp Video Speed \(page 143\)](#).

### TRAIL LENGTH (STAR TRAILS, VEHICLE LIGHT TRAILS)

Set the length of the light trails when recording with the Star Trails or Vehicle Light Trails presets. Choose Max for continuous trails with no breaks, long trails, or short trails.

## Time Lapse Settings

---

### FORMAT (TIME LAPSE, NIGHT LAPSE)

Switch from capturing Time Lapse and Night Lapse video to Time Lapse and Night Lapse photo. The photo format takes a continuous series of photos at set intervals. This lets you focus on your activity instead of on your camera. You can then look through all of your photos and find the best shots later.

### INTERVAL (TIME LAPSE)

Choose how often your camera captures a frame of video or takes a photo. Use shorter intervals for quick activities and longer intervals for extended activities.

To learn more, see [Time Lapse Interval \(page 145\)](#).

### INTERVAL (NIGHT LAPSE)

Set how often your camera takes a shot in low and ultra low-light scenes. Choose shorter intervals for scenes with a lot of movement and more light. Use longer intervals in scenes with little or no movement or light.

To learn more, see [Night Lapse Interval \(page 28\)](#).

### OUTPUT (TIME LAPSE PHOTO, NIGHT LAPSE PHOTO)

Save your photos as standard .jpg or RAW files.

To learn more, see [RAW Format \(page 142\)](#).

### SHUTTER (NIGHT LAPSE)

Set how long your camera's shutter stays open for night shots. Choose longer exposures for darker shots.

To learn more, see [Shutter Speed \(page 140\)](#).

### PROTUNE (TIMEWARP, TIME LAPSE VIDEO, NIGHT LAPSE VIDEO)



Take manual control of advanced video settings.

To learn more, see [Protune \(starting page 149\)](#).

## Live Streaming + Webcam Mode

---

### SETTING UP A LIVE STREAM

1. Connect to the GoPro Quik app. For details, see [Connecting to the GoPro Quik App \(page 92\)](#).
2. In the app, tap  to control your camera.
3. Tap  and follow the instructions to set up your stream.

For complete step-by-step instructions, visit [gopro.com/live-stream-setup](https://gopro.com/live-stream-setup).

### USING YOUR GOPRO AS A WEBCAM

Both your GoPro and computer must be set up for webcam mode before you go live. Your camera is in webcam mode by default. Connect your camera to your computer using the included USB-C cable, and then follow the step-by-step setup instructions at [gopro.com/webcam](https://gopro.com/webcam).



## Exposure Control

---

Your GoPro scans the entire scene to choose the exposure level for your shot. Exposure Control lets you decide if only a section of the shot should be used to set the exposure.

Check out the shot preview on your touch screen. Try Exposure Control if there are sections that are too dark or too light.

### SETTING EXPOSURE CONTROL

If you're snowboarding on a sunny day, you might try locking the exposure on your subject's jacket. This will help prevent your shots from being underexposed (too dark) compared to the bright snow.

1. Tap and hold anywhere on the rear touch screen until a set of brackets appears. The exposure will be based on area in the brackets.

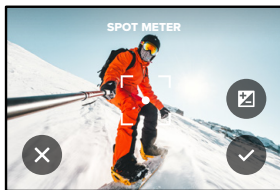

---

**PRO TIP:** Tapping and holding the center of the screen will bring up the Spot Meter. This will base the exposure on the center of the screen.

## Exposure Control

---

2. You can change the exposure by dragging the brackets to any other area of the screen.

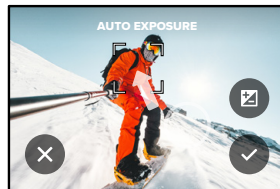

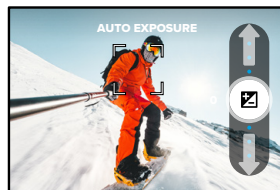

3. Brightness can be fine tuned by tapping . This lets you adjust the Exposure Value Compensation (EV Comp).



Slide up to brighten the image. Slide down to darken it. You can adjust up to two stops in either direction.

## Exposure Control

---

4. Check the screen to see if the exposure looks good. Tap  inside the brackets to lock in the exposure. You can also tap  to cancel any changes.

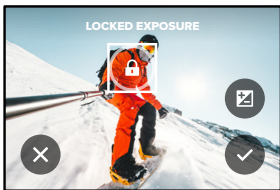

## Exposure Control

---

### TURNING EXPOSURE CONTROL OFF

Tapping the brackets on the capture screen will turn Exposure Control off and reset your camera to full-screen auto exposure.

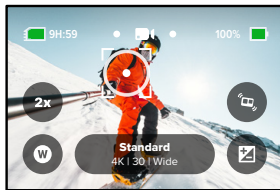

*Heads Up:* If the EV Comp was adjusted during Exposure Control, it will return to its default setting when Exposure Control is turned off. For details, see [Exposure Value Compensation \(EV Comp\)](#) (page 153).

## Controlling Your GoPro With Your Voice

---

Voice Control gives you easy, hands-free control of your GoPro. It's great when you're busy with handlebars, ski poles, and more. Just tell your GoPro what you want it to do.

### TURNING VOICE CONTROL ON + OFF

1. Swipe down on the rear screen to access the Dashboard.
2. Tap  to turn Voice Control on or off.

### CAPTURING WITH VOICE CONTROL

With Voice Control on, you can simply tell your GoPro to start capturing.

Command	Description
GoPro, capture	Starts capturing with the mode your camera is set to.
GoPro, stop capture	Stops capture in Video and Time Lapse modes. Photo and Burst mode stop on their own.

**PRO TIP:** Saying "GoPro, capture" and "GoPro, stop capture" is the hands-free way of pressing the Shutter button . They will start and stop capture using the mode and settings you currently have on your camera.

## Controlling Your GoPro With Your Voice

---

### LIST OF VOICE COMMANDS

There are two types of voice commands: Action commands and Mode commands.

### Using Action Commands

These commands let you switch modes on the fly. If you just recorded a video, you can say, "GoPro, take a photo" to snap a photo without manually switching modes.

Action Command	Description
GoPro, start recording	Starts recording video.
GoPro, HiLight	Adds a HiLight Tag to your video during recording.
GoPro, stop recording	Stops recording video.
GoPro, take a photo	Takes a single photo.
GoPro, shoot burst	Takes burst photos.
GoPro, start time lapse	Starts capturing with the last time lapse mode you used.
GoPro, stop time lapse	Stops capturing time lapse.
GoPro, turn off	Turns your camera off.

## Controlling Your GoPro With Your Voice

---

### Using Mode Commands

Use these commands to switch capture modes on the go. Then say, "GoPro, capture" or press the Shutter button  to get the shot.

Mode Command	Description
GoPro, Video mode	Switches your camera to Video mode (does <b>not</b> start recording).
GoPro, Photo mode	Switches your camera to Photo mode (does <b>not</b> take a photo).
GoPro, Time Lapse mode	Switches your camera to Time Lapse photo mode (does <b>not</b> start taking time lapse photos).

**PRO TIP:** If you're recording video or time lapse, you must stop recording by pressing the Shutter button  or by saying, "GoPro, stop capture" before trying a new command.

## Controlling Your GoPro With Your Voice

---

### SEE A COMPLETE LIST OF COMMANDS ON YOUR CAMERA

1. Swipe down on the rear screen to access the Dashboard.
2. Swipe left and tap Preferences > Voice Control > Commands.

### CHANGING YOUR VOICE CONTROL LANGUAGE

1. Swipe down on the rear screen to access the Dashboard.
2. Swipe left and tap Preferences > Voice Control > Language.

*Heads Up:* Voice Control may be affected by wind, noise, and your distance from the camera. Keep your camera clean and wipe away any debris for the best performance.





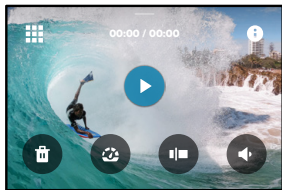

## Playing Back Your Media

---

Swipe up to see the last video, photo, or burst you took. Swipe left and right to flip through the other files on your SD card.





The Media Gallery includes the following playback options:

-  Pause playback
-  Resume playback
-  See all of the media on your SD card
-  See all of the modes and setting used to capture the shot
-  Delete the file from your SD card
-  Play back in slow motion or normal speed
-  Use a slider to scan through your videos, bursts, and time lapse photos

## Playing Back Your Media

---

-  Add/remove HiLight Tag
-  Adjust the playback volume
-  Go to the previous or next photo in a burst or group of continuous photos

*Heads Up:* The playback options will vary based on the type of media you're viewing.

---

**PRO TIP:** Some playback options are not available when you're holding your camera in portrait orientation. Make adjustments to those settings in landscape orientation before rotating your camera.

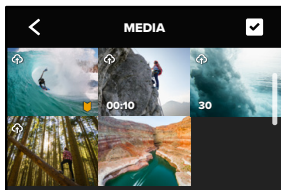

## Playing Back Your Media

---



### USING GALLERY VIEW

Gallery view gives you quick access to all of the videos and photos stored on your SD card.



1. From the playback screen, tap .
2. Swipe up to scroll through your media.
3. Tap a video or photo to see it in full-screen view.
4. Tap  to select files.
5. Tap  to go back to the playback screen.

*Heads Up:* Gallery view is not available when you're holding your camera in portrait orientation. Also, the more content you have on your SD card, the longer it will take to load.

## Playing Back Your Media

---

### DELETING MULTIPLE FILES

1. Tap .
2. Tap all of the files that you want to delete. Tap a file again if you want to de-select it.
3. Tap  to delete the selected files.

### VIEWING VIDEOS + PHOTOS ON A MOBILE DEVICE

1. Connect your camera to the GoPro Quik app. For details, see [Connecting to the GoPro Quik App \(page 92\)](#).
2. Use the controls on the app to play back, edit, and share your videos and photos.

### VIEWING VIDEOS + PHOTOS ON A COMPUTER

To see your media on a computer, you must first save the files to the computer. To learn more, see [Transferring Your Media \(page 94\)](#).

---

**PRO TIP:** Use the GoPro Quik app to grab still photos from videos, create short shareable videos from full-length footage, save media to your phone, and more.

## Connecting to the GoPro Quik App

---

### CONNECTING TO THE GOPRO QUIK APP

Use the GoPro Quik app to control your GoPro, share videos and photos on the go, and automatically transform your footage into awesome video stories synced with effects and music.

#### Connecting for the First Time

1. Download the GoPro Quik app from the Apple® App Store® or Google Play™.
2. Follow the app's on-screen instructions to connect your camera.

*Heads Up for iOS®:* When prompted, be sure to allow notifications from the GoPro Quik app so you know when your video is ready.

To learn more, see [Creating a Video Story \(page 94\)](#).

#### After the First Time

After you've connected once, you can start connecting through your camera's Connections menu.

1. If your camera's wireless is not already on, swipe down on the rear screen to access the Dashboard.
2. Swipe left and tap Preferences > Connections > Connect Device.
3. Follow the on-screen instructions in the GoPro Quik app to connect.

## Connecting to the GoPro Quik App

---

### SETTING THE CONNECTION SPEED

Your GoPro is set to use the 5GHz Wi-Fi band (the fastest available) when connecting to other mobile devices.

Change the Wi-Fi band to 2.4GHz if your device or region does not support 5GHz.

1. Swipe down on the rear screen to access the Dashboard.
2. Swipe left and tap Connections > Wi-Fi Band.

## Transferring Your Media

---

### CREATING A VIDEO STORY

You can set up your GoPro to automatically send videos and photos to your phone. The GoPro Quik app will use them to create a fully edited video story complete with music and effects.

1. Connect your camera to the GoPro Quik app. For details, see [Connecting to the GoPro Quik App \(page 92\)](#).
2. Swipe down on the app's home screen. Shots from your most recent session will be copied to your phone and transformed into a fully edited video.
3. Tap your video to view it.
4. Make any edits you'd like.
5. Save the story or share it with your friends, family, and followers.

### Finding the Best Shots

Be sure to mark your best shots with HiLight Tags. The GoPro Quik app looks for tags when it creates videos. This helps ensure that favorite moments are included in your stories.

Your GoPro also knows when you face the camera, smile, and more. It automatically tags these shots with data so the app can handpick them for your videos.

To learn more, see [Adding HiLight Tags \(page 48\)](#).

## Transferring Your Media

---

### TRANSFERRING TO YOUR PHONE WITH A WIRED CONNECTION

Use a wired connection to transfer photos and videos from your GoPro to your phone faster and more reliably.

1. Use the appropriate cable/adaptor (not included) to connect your GoPro to your phone.
2. Start the GoPro Quik app on your phone and follow the on-screen instructions.

Phone	Require Cable or Adapter
Android	Standard USB-C to USB-C
iOS® device with USB-C port	Standard USB-C to USB-C
iOS® device with Lightning port	Standard USB-A to USB-C and Apple® Lightning to USB Camera Adapter

### TRANSFERRING TO A COMPUTER

Copy your media from your SD card to a computer for playback and editing.

1. Remove the SD card from your camera.
2. Insert the card into an SD card reader or adapter.
3. Plug the card reader into your computer's USB port, or insert the adapter into the SD card slot.
4. Copy the files to your computer.



## Transferring Your Media

---

### AUTO UPLOADING TO THE CLOUD

With a GoPro subscription, you can automatically upload your media to the cloud where you can view, edit, and share it from any device.

1. Subscribe to GoPro at [gopro.com/subscribe](https://gopro.com/subscribe) or through the GoPro Quik app.
2. Connect your camera to the GoPro Quik app. For details, see [Connecting to the GoPro Quik App \(page 92\)](#).
3. Tap  on the camera chooser screen.
4. Connect your camera to a power outlet. The upload will start automatically.

After first-time setup, your camera won't need to connect to the app to start Auto Upload.

*Heads Up:* Your original files remain on your camera even after they've been backed up to the cloud.

### SWITCHING TO MANUAL CLOUD UPLOAD

You can also manually upload your media to the cloud at any time. (Your GoPro must be connected to a power outlet, and Auto Upload must be off.)

5. Connect your camera to a power outlet.
6. Swipe down to access the Dashboard.
7. Tap Preferences > Auto Upload > Manual Upload.

### ACCESSING YOUR CLOUD MEDIA

1. Open the GoPro Quik app on your device.
2. Tap  and select Cloud to view, edit, and share your content.

---

**PRO TIP:** Use your cloud media to create video stories with the GoPro Quik app. Simply choose Cloud Media when you start a new story.

## Transferring Your Media

---

### AUTO CLEAR

Your camera can be set to automatically delete all of the media from your camera's SD card once it has been safely uploaded to the cloud. This ensures that there's room on your SD card for new photos and videos the next time you use your GoPro.

Auto Upload will also recognize any new photos and videos on your SD card the next time your camera is plugged in for cloud backup. Only the new files will be saved to the cloud and deleted from your SD card.

1. Swipe down on the rear screen to access the Dashboard.
2. Tap Preferences > Auto Upload > Auto Clear.

*Heads Up:* If you have not turned on Auto Clear in Preferences, your GoPro will ask if you want to clear the media from your SD card after the cloud upload is complete.

## Transferring Your Media

### TURNING OFF AUTO UPLOAD

You can keep your camera from trying to upload every time it's connected to a power outlet and fully charged.

1. Swipe down on the rear screen to access the Dashboard.
2. Swipe left and tap Connections > GoPro Subscription > Auto Upload.
3. Tap Off.

### CONNECTING TO A DIFFERENT WIRELESS NETWORK

1. Connect your camera to the GoPro Quik app. For details, see [Connecting to the GoPro Quik App \(page 92\)](#).
2. After connecting, tap Manage Auto Upload on the app.
3. Tap Wi-Fi Networks on the app.
4. Choose a Wi-Fi network.
5. Enter the Wi-Fi password.
6. Tap Connect.

### CHANGING YOUR GOPRO SUBSCRIPTION PREFERENCES

Manage your Auto Upload settings, set up your wireless network, and more.

1. Swipe down on the rear screen to access the Dashboard.
2. Swipe left and tap Connections > GoPro Subscription.

*Heads Up:* GoPro Subscription will be available in your Preferences after you've signed up.

## Setting Your Preferences





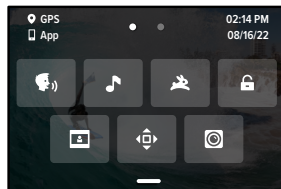

### USING THE DASHBOARD

With your camera in landscape orientation, swipe down on the rear screen to access the Dashboard.



### DASHBOARD FEATURES

The Dashboard lets you quickly tap the following settings on and off:

- |   |               |   |                       |
|---|---------------|---|-----------------------|
|  | Voice Control |  | Front Screen Settings |
|  | Camera Beeps  |  | Orientation Lock      |
|  | QuikCapture   |  | Max Lens Mod Mode     |
|  | Screen Lock   |   |                       |

## Setting Your Preferences

---

Swipe down on the rear screen to access the Dashboard, and then swipe left to access your GoPro's preferences.



### WIRELESS CONNECTIONS

Connect your GoPro to the GoPro Quik app, choose your Wi-Fi band, and more.

#### Wireless Connections

Turn your camera's wireless connections on and off.

#### Connect Device

Choose to connect to the GoPro Quik app or The Remote.

To learn more, see [Connecting to the GoPro Quik App \(page 92\)](#).

#### Camera Info

See your camera's name and password.

#### Wi-Fi Band

Choose 5GHz or 2.4GHz as your connection speed. Set 5GHz only if your phone and region support it.

To learn more, see [Setting the Connection Speed \(page 93\)](#).

#### Reset Connections

Clear all connections to your devices and reset your camera's password. This means you'll have to reconnect each device.

## Setting Your Preferences

---



### GENERAL

Here's everything you'll find under General settings:

#### Beep Volume

Choose High, Med (default), Low, or Mute. The volume you set here can be toggled on or off using the Dashboard.

#### QuikCapture

QuikCapture is on by default. You can turn it off here. It can also be toggled on or off using the Dashboard.

#### Default Preset

Set the preset your GoPro captures in when you turn it on using the Mode button . This setting does not affect QuikCapture.

#### Auto Power Off

Choose 5 Min, 15 Min (default), 30 Min, or Never.

#### LEDs

Set which status lights blink. Choose All On (default), All Off, or Front Off Only.

#### Anti-Flicker

Choose the regional frame rate for recording and playback on a TV. Set 60Hz (NTSC) for North America. Try 50Hz (PAL) if you're outside of North America. The right format for your region will help prevent flicker on a TV/HDTV when you play back video that was recorded indoors.

## Setting Your Preferences

---

### Time and Date

Use to manually adjust the time and date. Both are automatically updated when you connect your camera to the GoPro app.

### Date Format

This is set automatically based on the language that you chose at setup. You can also change it manually here.

### Time Zone

Set your camera's time zone.

### Daylight Savings Time

Turn daylight savings time on if you are in a region that is currently observing daylight savings time. Your camera's clock will set itself one hour ahead. Turn daylight savings time off when daylight savings time is over to return to standard time.

## Setting Your Preferences

---



### VOICE CONTROL

Choose your Voice Control settings and see all of the available commands.

#### Voice Control

Turn Voice Control on and off. It can also be toggled on or off using the Dashboard.

#### Language

Choose your Voice Control language.

#### Commands

See a complete list of voice commands.

To learn more, see [Controlling Your GoPro With Your Voice \(page 84\)](#).

## Setting Your Preferences

---



### DISPLAYS

Adjust Orientation, set the Screen Saver, and adjust brightness.

#### Orientation

Keeps your screen right-side up when you rotate your camera.

To learn more, see [Setting the Screen Orientation \(page 49\)](#).

#### Screen Saver Rear

Set the rear screen saver to 1, 2 (default), 3, or 5 minutes. Choose Never to leave your screen on.

*Heads Up:* The camera buttons and Voice Control still work even when the screen is off.

#### Screen Saver Front

Set the front screen saver to 1, 2, 3, or 5 minutes. You can also choose Never or Match Rear (default) to sync with the rear screen saver.

#### Brightness

Use the slider to adjust your screen's brightness.

## Setting Your Preferences

---



### LANGUAGE

Turn on GPS, choose your language, and see all of your camera's regulatory information.

#### GPS

Turn on GPS to track your speed, distance, and more. Add data overlays using the GoPro Quik app to show how fast, far, and high you were going in your videos. For more information and mobile device compatibility, check out [gopro.com/telemetry](https://gopro.com/telemetry).

#### Language

Choose the language that appears on the camera.



### MODS

Use these settings with HERO11 Black Mods.

#### Max Lens Mod

Adds Max Lens Mod control to your camera's Dashboard.

#### Media Mod

Choose the type of external microphone you're connecting to Media Mod.

## Setting Your Preferences

---



### ABOUT

Update your GoPro, plus find your camera's name, serial number, battery condition, and software version.

### GoPro Updates

Update your camera's software to ensure you have the latest features and performance upgrades.

### Camera Info

Find your camera's name and serial number, and see which software version your camera is using.

### Battery Info

Check your battery's health here. Be sure to use a GoPro Enduro Battery. Using an older GoPro battery or non-GoPro battery could greatly limit your camera's performance.



### REGULATORY

See your GoPro's certifications.

## Setting Your Preferences

---



### RESET

Format your SD card or reset your camera's settings.

### Format SD Card

Reformat your SD card. This will erase all of your media, so be sure to save it first.

### Reset Presets

Reset the preloaded presets to their original settings and delete all custom presets.

### Reset Camera Tips

See all of the camera tips from the beginning.

### Factory Reset

Restore all of your camera's settings and clear all connections.

## Important Messages

---

Problems are rare, but your GoPro will let you know if anything comes up. Here are some of the messages you might see.



### CAMERA IS TOO HOT

The Temperature icon appears on the touch screen if your camera becomes too hot and needs to cool down. Your camera was designed to recognize when it's at risk of overheating and will shut down when needed. Simply let it sit and cool before using it again.

*Heads Up:* The operating ambient temperature range of your HERO11 Black is 14° F ~ 95° F (-10° C ~ 35° C) with a charging temperature of 32° F ~ 95° F (0° C ~ 35° C). High temperatures will cause your camera to use more power and drain the battery faster.

---

**PRO TIP:** Shooting video at a high resolution and frame rate will also cause your camera to heat up faster, especially in hot environments. Try switching to a lower resolution and frame rate to lower the risk of overheating your GoPro.

### SD CARD ERROR

Your GoPro can detect a variety of problems with your SD card. Problems can be due to, but not limited to, electrostatic discharge. Restart your camera if this occurs. It will automatically try to repair any damaged files and restore your camera back to full function.

## Important Messages

---



### REPAIRING YOUR FILE

Your GoPro will automatically try to fix damaged files. Files can be damaged if your camera loses power while recording or if there's a problem saving the file. The File Repair icon will appear on the touch screen when a repair is in progress. Your camera will let you know when it's finished and if the file was fixed.

### MEMORY CARD FULL

Your camera will let you know when your SD card is full. You'll need to move or delete some files if you want to keep recording.

### SD CARD RATING

Your camera needs an SD card rated V30, UHS-3, or higher to operate at its best. It will let you know if your card is rated below V30/UHS-3 or if your card has degraded over time and can no longer perform up to its standards.

### BATTERY LOW, POWERING OFF

A low-battery message will appear on the touch screen when the battery charge drops below 10%. If the charge runs out while recording video, your camera will stop recording, save the video, and turn itself off.

## Resetting Your Camera

---

### RESTARTING YOUR GOPRO

If your camera is not responding, press and hold the Mode button  for 10 seconds. This will restart your camera. There will be no changes to your settings.

### RESTORE PRESETS TO THE DEFAULTS

This will reset all of your camera's original preset settings to the defaults.

1. Swipe down on the rear screen to access the Dashboard.
2. Swipe left and tap Preferences > Reset > Reset Presets.

*Heads Up:* Restoring your camera's original preset settings to their defaults will delete your custom presets.

### RESETTING CONNECTIONS

This will clear your device connections and reset your camera's password. Resetting connections means you'll have to reconnect all of your devices.

1. Swipe down on the rear screen to access the Dashboard.
2. Swipe left and tap Connections > Reset Connections.

### RESETTING THE CAMERA TIPS

Want to see the camera tips again? Here's how to see them all from the beginning.

1. Swipe down on the rear screen to access the Dashboard.
2. Swipe left and tap Preferences > Reset > Reset Camera Tips.

## Resetting Your Camera

---

### RESTORING FACTORY SETTINGS

This will restore all of your camera's original settings, clear all device connections, and deregister your camera from your GoPro subscription. This is useful if you're giving your camera to a friend and want to completely reset it to its original state.

1. Swipe down on the rear screen to access the Dashboard.
2. Swipe left and tap Preferences > Reset > Factory Reset.

*Heads Up:* Restoring the factory settings will not delete any content from your SD card or have any effect on your camera's software.



## Mounting Your GoPro

---

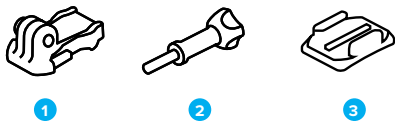

### MOUNTING HARDWARE

1. Mounting Buckle
2. Thumb Screw
3. Curved Adhesive Mount

## Mounting Your GoPro

---

### USING THE MOUNTING FINGERS

Depending on the mount you're using, you'll either use a mounting buckle or attach your GoPro directly to the mount itself.

See [Using the Adhesive Mounts \(page 115\)](#) for tips on using adhesive mounts.

1. Flip the folding fingers down into the mounting position.
2. Interlock the folding fingers on your camera with the mounting fingers on the buckle.
3. Secure your camera to the mounting buckle with a thumb screw.

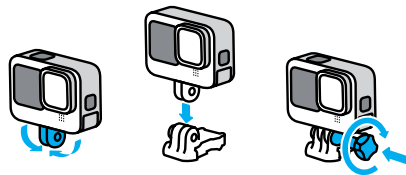

## Mounting Your GoPro

---

4. Attach the mounting buckle to the mount.
  - a. Flip up the mounting buckle plug.
  - b. Slide the buckle into the mount until it clicks into place.
  - c. Press the plug back down so that it sits flush with the buckle.

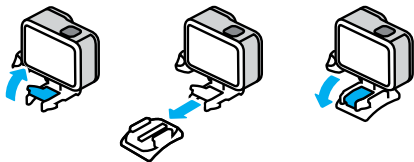

## Mounting Your GoPro

---

### USING THE ADHESIVE MOUNTS

Follow these guidelines when attaching adhesive mounts to helmets, vehicles, and gear:

- Attach mounts at least 24 hours before you use them.
- Only attach the mounts to smooth surfaces. They won't stick properly to porous or textured surfaces.
- Firmly press mounts into place. Be sure the adhesive is in full contact with the surface.
- Only use on clean, dry surfaces. Wax, oil, dirt, or other debris will weaken the bond, and you could lose your camera.
- Attach mounts in dry, room-temperature conditions. They won't stick properly in cold or damp environments or on cold or damp surfaces.
- Check state and local regulations and laws to ensure that attaching a camera to equipment (such as hunting gear) is permitted. Always comply with regulations that restrict the use of consumer electronics or cameras.



**WARNING:** To avoid injury, do not use a tether when mounting your camera on a helmet. Do not mount the camera directly on skis or snowboards.

---

For more information about mounts, visit [gopro.com](https://gopro.com).

## Mounting Your GoPro

---



**WARNING:** Always use a helmet that meets applicable safety standards if you're using a GoPro helmet mount or strap.

Choose the right helmet for your sport or activity, and make sure that it's the right size and fit for you. Check to see that your helmet's in good condition, and always follow the manufacturer's instructions on safe use.

Replace any helmet that's been subjected to a major impact. No helmet can protect against injury in every accident. Be safe.

---

### USING YOUR GOPRO IN + AROUND WATER

Your GoPro is waterproof to 33ft (10m) with the door locked. You won't need an additional housing before diving in.

The touch screen was designed to work when wet, but you may need to wipe it off if it has trouble sensing your commands. Although it will not work under water, you can use the camera's buttons to navigate the menus when you're submerged.

To learn more, see [Navigating With the Buttons \(page 28\)](#).

---

**PRO TIP:** Use a camera tether and a Floaty (sold separately) to keep your camera afloat in case it detaches from the mount.

To capture extreme adventures down to 196ft (60m), pick up the Protective Housing (HERO11 Black), sold separately.

For more information on Camera Tethers, Floaty, and the Protective Housing, visit [gopro.com](https://gopro.com).

## Removing the Door

---

There might be times when you need to remove your camera's door.

**NOTE:** Only remove the door in a dry, dust-free environment. The camera is not waterproof when the door is open or removed.

### REMOVING THE DOOR

1. Unlock the latch, and flip the door open.
2. With the door in a horizontal position, gently pull outward until it snaps off.

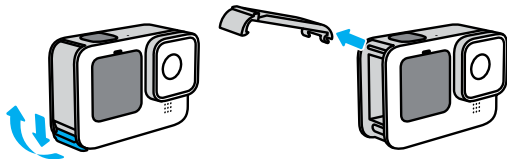

**WARNING:** Avoid using your GoPro with the door off. The battery could slide out during use.

---

## Removing the Door

---

### REATTACHING THE DOOR

1. Line the door up with the small silver bar.
2. Press the door tightly into the small silver bar until it snaps into place and is securely attached.

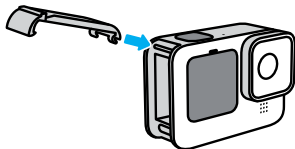

**WARNING:** Your camera's door is removable. Be sure that the door is securely locked and sealed after closing.

---

## Maintenance

---

Follow these tips to get the best performance from your camera:

- Your GoPro is waterproof to 33ft (10m)—no housing needed. Be sure the door is closed before using it in or around water, dirt, or sand.
- Before closing the door, be sure the seal is free of debris. Use a cloth to clean the seal if needed.
- Make sure your GoPro is dry and clean before opening the door. Rinse your camera with fresh water and dry it with a cloth if needed.
- If sand or debris hardens around the door, soak your camera in warm tap water for 15 minutes and then rinse thoroughly to remove the debris. Make sure your camera is dry before opening the door.
- For the best audio performance, shake your camera or blow on the mic to remove water and debris from the microphone holes. Do not use compressed air to blow into the mic holes. This could damage the internal waterproof membranes.
- After every use in salt water, rinse your camera with fresh water, and dry it with a soft cloth.
- The lens cover is made from extremely tough strengthened glass, but it can still be scratched or cracked. Keep it clean with a soft, lint-free cloth.
- If debris gets stuck between the lens and trim ring, flush it out with water or air. Do not insert foreign objects around the lens.

## Battery Information

---

### MAXIMIZING BATTERY LIFE

Here are some things you can do to maximize battery life:

- Capture video at lower frame rates and resolutions.
- Use the Screensaver and lower the screen Brightness.
- Turn off the front screen.
- Turn off GPS.
- Turn off Wireless Connections.
- Use these settings:
  - *Using QuikCapture (page 47)*
  - *Auto Power Off (page 101)*

### RECORDING WHEN PLUGGED INTO A POWER SOURCE

You can use the USB-C cable that came with your camera to shoot videos and photos while your camera is plugged in to a USB-charging adapter, the GoPro Supercharger, or other external power source. This is perfect for capturing long videos and time lapse events.

Be careful not to touch the area near the SD card slot when recording. Disturbing the SD card could interrupt or stop the recording. Your camera will let you know if this happens. Your content will not be damaged or lost as a result of this disturbance, but you may need to restart your camera to continue.

Even though your camera is charging, the battery will not charge during recording. It will start charging when you stop recording. You cannot record while your camera is plugged into a computer.

## Battery Information

---

*Heads Up:* Because the door is open, your camera is not waterproof when charging.

---

**PRO TIP:** Use the USB Pass-Through Door (sold separately) to keep your camera weather resistant and the battery in place when plugged into an external power source.



**WARNING:** Using a non-GoPro wall charger or power cable could damage your camera battery and could lead to fire or leakage. With the exception of the GoPro Supercharger (sold separately), only use chargers marked Output 5V 1A. If you don't know your charger's voltage and current, use the included USB-C cable to charge your camera with a computer.

---

### BATTERY STORAGE + HANDLING

Your GoPro is full of sensitive components, including the battery. Avoid exposing your camera to very hot or cold temperatures. Extreme temperatures may temporarily shorten battery life or cause your camera to temporarily stop working properly. Avoid dramatic temperature or humidity changes as condensation may form on or within the camera.

Do not dry your camera with an external heat source such as a microwave oven or a hair dryer. Damage to the camera or battery caused by contact with liquid inside the camera is not covered under the warranty.

Do not store your battery with metal objects like coins, keys, or necklaces. If the battery terminals come in contact with metal objects, this may cause a fire.

## Battery Information

---

Do not make any unauthorized alterations to your camera. Doing so may compromise safety, regulatory compliance, and performance, and may void the warranty.

*Heads Up:* Batteries have reduced capacity in cold weather. This affects older batteries even more. If you regularly shoot at low temperatures, replace batteries yearly for optimal performance.

---

**PRO TIP:** Fully charge your camera before storing it away to help maximize battery life.

---



**WARNING:** Do not drop, disassemble, open, crush, bend, deform, puncture, shred, microwave, incinerate, or paint your camera or battery. Do not insert foreign objects into any opening on the camera, such as the USB-C port. Do not use your camera if it's been damaged—for example, if cracked, punctured, or harmed by water. Disassembling or puncturing the integrated battery can cause an explosion or fire.

---

## Battery Information

---

### BATTERY DISPOSAL

Most rechargeable lithium-ion batteries are classified as non-hazardous waste and are safe for disposal in the normal municipal waste stream. Many regions require battery recycling. Check your local laws to make sure that you can dispose of rechargeable batteries in your regular trash. To safely dispose of lithium-ion batteries, protect terminals from exposure to other metal with packing, masking, or electrical tape so they do not cause a fire while being transported.

Lithium-ion batteries, however, do contain recyclable materials and are accepted for recycling by the Rechargeable Battery Recycling Corporation's (RBRC) Battery Recycling Program. We encourage you to visit Call2Recycle at [call2recycle.org](http://call2recycle.org) or call 1-800-BATTERY in North America to find a convenient recycling location.

Never dispose of a battery in a fire because it may explode.

---



**WARNING:** Only use GoPro replacement batteries, power cables, and battery charging accessories or devices with your camera.

Using an older GoPro battery or non-GoPro battery could greatly limit your camera's performance, will void your warranty, and may cause fire, electric shock or other safety risk.

---

## Troubleshooting

---

### MY GOPRO WON'T POWER ON

Make sure your GoPro is charged. See [SD Card + Battery Setup \(page 10\)](#). If charging the battery doesn't work, try restarting your camera. See [Restarting Your GoPro \(page 110\)](#).

### MY GOPRO WON'T RESPOND WHEN I PRESS A BUTTON

See [Restarting Your GoPro \(page 110\)](#).

### PLAYBACK ON MY COMPUTER IS CHOPPY

Choppy playback is usually not a problem with the file. If your footage skips, one of these issues is probably the cause:

- The computer doesn't work with HEVC files. Try downloading the latest version of the GoPro Player for Mac® or Windows® for free at [gopro.com/apps](https://gopro.com/apps).
- Your computer doesn't meet the minimum requirements of the software you're using for playback.

### I FORGOT MY CAMERA'S USERNAME OR PASSWORD

Swipe down on the rear screen to access the Dashboard, swipe left, and then tap Preferences > Connections > Camera Info.

### I DON'T KNOW WHICH SOFTWARE VERSION I HAVE

Swipe down on the rear screen to access the Dashboard, swipe left, and then tap Preferences > About > Camera Info.

### I CAN'T FIND MY CAMERA'S SERIAL NUMBER

The serial number is stamped inside the battery compartment of your camera. You can also find it by swiping down on the rear screen to access the Dashboard, swiping left, and then tapping Preferences > About > Camera Info.

For more answers to commonly asked questions, see [gopro.com/help](https://gopro.com/help).

## Tech Specs: Video

---

### VIDEO RESOLUTION (RES)

Video resolution refers to the number of horizontal lines used in each frame of video. A 1080p video is made up of 1080 horizontal lines. A 5.3K video is made up of 5312 horizontal lines. Since more lines equals greater resolution, 5.3K will deliver a more detailed picture than 1080p.

Video Resolution	Description
5.3K	Ultra high-resolution video that captures breathtaking ultra HD video in the wide 16:9 aspect ratio. Can be used to grab 15.8MP stills from your video.
5.3K 4:3	Ultra high-resolution video that captures more of the scene with the taller 4:3 aspect ratio. Great for point-of-view footage and grabbing 21MP stills from your video.
5.3K 8:7	Ultra high-resolution video that captures the tallest and widest field of view ever on a HERO camera. Great for zooming in while keeping the rich textures and sharpness of your footage and grabbing 24.7MP stills from your video.
4K 4:3	Ultra HD video with tall 4:3 aspect ratio captures more of the scene than 16:9 shots. Can be used to grab 12MP stills from your video.
4K	Ultra HD video with 16:9 aspect ratio. Great for tripod and fixed-position shots. Can be used to grab 8MP stills from your video.

## Tech Specs: Video

---

Video Resolution	Description
4K 8:7	Ultra HD video in the extra tall and wide 8:7 aspect ratio. Great for capturing immersive POV footage that lets you change digital lenses, crop your shot, and adjust aspect ratios after recording. Can be used to grab 12.9MP stills from your video.
2.7K 4:3	Great for high-resolution point-of-view body and gear-mounted shots with fluid slo-mo playback.
2.7K	High resolution 16:9 video that provides stunning, cinema-quality results for professional productions.
1080p	Standard HDTV resolution that's great for all shots and sharing to social media. High 240 fps and 120 fps options enable super slo-mo during editing.

## Tech Specs: Video

---

### FRAMES PER SECOND (FPS)

Frames per second refers to the number of frames captured in each second of video. Higher fps values (60, 120, or 240) are better at capturing fast-action shots. You can also use high fps footage for slow motion playback.

### Slo-Mo + FPS

Normal speed video is typically captured and played back at 30 fps. As a result, video that is captured at 60 fps can be played back at 2x slow motion (1/2 speed). Video that is recorded at 120 fps can be played back at 4x slow motion (1/4 speed), and video recorded at 240 fps can be played back at 8x slow motion (1/8 speed).

Videos recorded at higher fps will also have more fluid motion with greater detail when watched in slow motion.

### Resolution + FPS

Higher video resolutions capture more detail and clarity, but they're generally available at lower fps values.

Lower video resolutions capture less detail and clarity, but they can be shot at higher fps values.

When choosing a resolution on the RES | FPS screen, all of the available frame rates for the resolution you selected are shown in white.

Unavailable frame rates are in gray.



## Tech Specs: Video

---

### ASPECT RATIO (VIDEO)

Aspect ratio refers to the width and height of an image. Your GoPro captures videos and photos in three aspect ratios.

#### 8:7

This ultra immersive format is the tallest and widest field of view ever on a GoPro HERO camera—allowing you to capture more of the scene in each shot. This lets you zoom in and focus on chosen sections of your footage to create high-resolution punchouts of the action in any aspect ratio, while cropping out the rest of the shot using the GoPro Quik app or other editing software. The 8:7 resolutions are listed in the top row of the RES | FPS screen.

#### 4:3

The tall 4:3 format captures more of the scene than the 16:9 widescreen format. It's great for selfies and point-of-view footage. The 4:3 resolutions are listed in the top row of the RES | FPS screen.

#### 16:9

This is the standard format used for HDTV and editing programs. The widescreen format is ideal for capturing dramatic, cinematic footage. The 16:9 resolutions are listed below the 4:3 resolutions on the RES | FPS screen.

*Heads Up:* Black bars will appear on both sides of the screen when playing back 4:3 and 8:7 footage on an HDTV.

## Tech Specs: Video

---

### DIGITAL LENSES (VIDEO)

Digital lenses let you choose how much of the scene is captured by your camera. The different lenses also affect the zoom level and the fisheye effect in your shot.

Digital Lens	Description
	Our tallest and widest field of view in ultra immersive 16:9 video.
HyperView (16mm)	<i>Heads Up:</i> HyperView stretches 8:7 footage to fit a 16:9 screen. The result is ultra immersive footage with a fish-eye effect. It's best used for POV action sports footage rather than general recording.
SuperView (16mm)	Serves up tall 4:3 aspect ratio footage as immersive 16:9 video.
Wide (16–34mm)	Wide field of view that captures as much as possible within the frame.
Linear + Horizon Lock / Horizon Leveling (19–33mm)	Captures a wide field of view without the fisheye effect of HyperView, SuperView, or Wide. Keeps your footage smooth and level even if your camera rotates while recording.  To learn more, see <a href="#">Horizon Lock / Horizon Leveling (starting page 133)</a> .
Linear (19–39mm)	Wide field of view without the fisheye effect of SuperView and Wide.

*Heads Up:* Only the lenses that are compatible with the resolution and frame rate you selected will be available.

**PRO TIP:** Use Max Lens Mod (sold separately) to boost your field of view with an ultra-wide 155° digital lens—the widest ever on a HERO camera.

## Tech Specs: Video

### HIGHEST QUALITY VIDEO MODE

Here's a full rundown of your camera's video resolutions, frame rates (fps), digital lenses, and aspect ratios in Highest Quality video mode.

Video Resolution (RES)	FPS (60Hz/50Hz)*	Digital Lenses	Screen Resolution	Aspect Ratio
5.3K	60/50	SuperView, Wide, Linear, Linear + Horizon Leveling	5312x2988	16:9
5.3K	30/25 24/24	HyperView, SuperView, Wide, Linear, Linear + Horizon Lock	5312x2988	16:9
5.3K 4:3	30/25 24/24	Wide, Linear, Linear + Horizon Lock	5312x3984	4:3
5.3K 8:7	30/25	Wide	5312x4648	8:7
4K	120/100	SuperView, Wide, Linear, Linear + Horizon Leveling	3840x2160	16:9
4K	30/25 24/24	SuperView, Wide, Linear, Linear + Horizon Lock	3840x2160	16:9
4K	60/50	HyperView, SuperView, Wide, Linear, Linear + Horizon Lock	3840x2160	16:9

## Tech Specs: Video

Video Resolution (RES)	FPS (60Hz/50Hz)*	Digital Lenses	Screen Resolution	Aspect Ratio
4K 4:3	60/50 30/25 24/24	Wide, Linear, Linear + Horizon Lock	4000x3000	4:3
4K 8:7	30/55	Wide	5312x4648	8:7
2.7K	240/200	Wide, Linear, Linear + Horizon Leveling	2704x1520	16:9
2.7K	120/100 60/50	SuperView, Wide, Linear, Linear + Horizon Lock	2704x1520	16:9
2.7K 4:3	120/100 60/50	Wide, Linear, Linear + Horizon Lock	2704x2028	4:3
1080p	240/200	Wide, Linear, Linear + Horizon Leveling	1920x1080	16:9
1080p	120/100 60/50 30/25 24/24	SuperView, Wide, Linear, Linear + Horizon Lock	1920x1080	16:9

For tips on which settings to use, see [Suggested Settings \(page 34\)](#).

\*60Hz (NTSC) and 50Hz (PAL) refer to the video format, which depends on your region. To learn more, see [Anti-Flicker \(page 101\)](#).

## Tech Specs: Video

---

### EXTENDED BATTERY VIDEO MODE

Extended Battery mode uses these resolutions and frame rates to help extend recording time while giving you mid-range quality video:

Video Resolution (RES)	FPS (60Hz/50Hz)*	Digital Lenses	Screen Resolution	Aspect Ratio
5.3K	30/25 24/24	HyperView, SuperView, Wide, Linear	5312x2988	16:9
4K	60/50	HyperView, SuperView, Wide, Linear	3840x2160	16:9
4K	30/25 24/24	SuperView, Wide, Linear	3840x2160	16:9
4K 4:3	60/50 30/25 24/24	Wide, Linear	4000x3000	4:3
2.7K	60/50	SuperView, Wide, Linear	2704x1520	16:9
2.7K 4:3	60/50	Wide, Linear	2704x2028	4:3

For tips on which settings to use, see [Suggested Settings \(page 34\)](#).

\*60Hz (NTSC) and 50Hz (PAL) refer to the video format, which depends on your region. To learn more, see [Anti-Flicker \(page 101\)](#).

## Tech Specs: Video

---



### High Resolutions/High Frame Rates

Shooting high-resolution or high-fps video when it's warm out can cause your camera to heat up and use more power.

Lack of airflow and connecting to the GoPro Quik app can cause your camera to warm up even more, use even more power, and shorten recording time.

If heat's a problem, try recording shorter videos. Also limit use of features that take a lot of power, such as the GoPro Quik app. The Remote (sold separately) can control your GoPro while using less energy.

Your camera will tell you if it needs to shut down and cool off.

To learn more, see [Important Messages \(page 108\)](#).

### HORIZON LOCK / HORIZON LEVELING

Your GoPro can give your videos the cinematic look of professional productions by keeping the horizon straight and level. Depending on the resolution and frame rate, your camera will record with either Horizon Lock or Horizon Leveling.

---

**PRO TIP:** Combine Horizon Control with HyperSmooth for ultimate video stabilization.

## Tech Specs: Video

---

### Horizon Lock

Horizon Lock keeps your footage locked and steady (on the horizontal or vertical axis) even if your camera rotates a full 360° while recording. It's available when recording 16:9 and 4:3 aspect ratio footage using most frame rates at each resolution.

### Horizon Leveling

Horizon Leveling keeps your footage smooth and level even if your camera tilts while recording. It's available when recording 16:9 aspect ratio footage at the highest frame rate of each resolution (5.3K60, 4K120, 2.7K240, and 1080p240).

Video Resolution (RES)	FPS (60Hz/50Hz)*	Digital Lens	Aspect Ratio
5.3K	60/50	Linear + Horizon Leveling	16:9
5.3K	30/25 24/24	Linear + Horizon Lock	16:9
5.3K 4:3	30/25 24/24	Linear + Horizon Lock	4:3
4K	120/100	Linear + Horizon Leveling	16:9
4K	60/50 30/25 24/24	Linear + Horizon Lock	16:9

## Tech Specs: Video

---

Video Resolution (RES)	FPS (60Hz/50Hz)*	Digital Lens	Aspect Ratio
4K 4:3	60/50 30/25 24/24	Linear + Horizon Lock	4:3
2.7K	240/200	Linear + Horizon Leveling	16:9
2.7K	120/100 60/50	Linear + Horizon Lock	16:9
2.7K 4:3	120/100 60/50	Linear + Horizon Lock	4:3
1080p	240/200	Linear + Horizon Leveling	16:9
1080p	120/100 60/50 30/25 20/20	Linear + Horizon Lock	16:9

*Heads Up:* Horizon Control is not available when recording 8:7 aspect ratio footage.

\*60Hz (NTSC) and 50Hz (PAL) refer to the video format, which depends on your region. To learn more, see [Anti-Flicker \(page 101\)](#).

## Tech Specs: Video

---

### HYPERSMOOTH VIDEO STABILIZATION

HyperSmooth delivers ultra smooth footage by correcting for camera shake. It crops your videos while recording, which lets it buffer the footage. This makes it perfect for biking, skating, skiing, handheld shots, and more. Your GoPro has four HyperSmooth settings:

Setting	Description
AutoBoost	Combines maximum video stabilization with the widest field of view possible. Cropping varies based on the level of stabilization required for the shot.
Boost	Maximum video stabilization with tight cropping.
On	High-level video stabilization with minimal cropping.
Off	Records without video stabilization or cropping.

You can smooth out your footage even more by using Touch Zoom to crop your shots before you start recording. This will give your camera an even bigger buffer to use when stabilizing your video. Using Horizon Lock will also enhance stabilization.

---

**PRO TIP:** Use Max Lens Mod (sold separately) to max out your GoPro with the ultimate in unbreakable video stabilization up to 2.7K.

### LOOPING INTERVAL

You can set your GoPro to record 5 (default), 20, 60, or 120 minute loops. It can also be set to Max, which will record until your SD card is full before looping back to record over the start of the video.

## Tech Specs: Photo

---

### ASPECT RATIO (PHOTO)

Aspect ratio refers to the width and height of an image. Your GoPro captures 27MP photos in the 8:7 aspect ratio. This ultra immersive format is the tallest and widest field of view ever on a GoPro HERO camera. The added height makes it perfect for creating extra-tall 9:16 vertical shots or any other size you need for any social media platform.

### Photo Editing With the GoPro Quik App

The 8:7 aspect ratio combines with the 27MP photo resolution to give you an extra-large canvas for your creativity. The GoPro Quik app features a variety of tools designed to make editing easy.

- Crop and zoom in on selected portions of your photos without losing the details in your shot.
- Switch digital lens effects to adjust the field of view of your photos.
- Change the aspect ratio of your shots.

## Tech Specs: Photo

---

### SUPERPHOTO

SuperPhoto automatically analyzes the scene and intelligently applies the best image processing for the shot.

Depending on the lighting, movement in your shot, and other conditions, SuperPhoto will choose one of three options:

#### High Dynamic Range (HDR)

Our improved HDR takes and combines multiple photos into a single shot to bring out the details in scenes that mix bright light and shadows.

#### Multi-Frame Noise Reduction

Automatically combines multiple shots into a single photo with less digital distortion (noise).

#### Standard Photo

Includes Local Tone Mapping, which enhances photos by boosting the details and contrast only where it's needed.

SuperPhoto only works for single photos. Because of the extra time needed to apply image processing, it may take a little longer to process and save each shot.

*Heads Up:* SuperPhoto does not work with RAW photos, Protune, or Exposure Control.

#### Turning SuperPhoto Off

SuperPhoto is on by default. Here's how to turn it off.

1. From the Photo settings screen, tap Output.
2. Switch to Standard, HDR, or RAW.

## Tech Specs: Photo

---

### HDR

High Dynamic Range (HDR) is one of the image-processing techniques SuperPhoto uses to enhance your shots. It combines multiple shots into a single photo with better results than ever. Choose this setting if you want to use HDR every time you take a photo.

1. From the Photo settings, tap Output.
2. Select HDR.

HDR On can only be used for single photos. For the best results, use it in high-contrast shots with minimal motion.

*Heads Up:* HDR does not work with RAW or Exposure Control.

## Tech Specs: Photo

---

### SHUTTER SPEED (NIGHT + NIGHT LAPSE PHOTO)

Shutter speed lets you decide how long your camera's shutter stays open in Night and Night Lapse Photo modes. Here are your options, plus tips on when to use them:

Speed	Examples
Auto (up to 30 seconds)	Sunrise, sunset, dawn, dusk, twilight, night.
2, 5, 10, or 15 seconds	Dawn, dusk, twilight, traffic at night, Ferris wheel, fireworks, light painting.
20 seconds	Night sky (with light).
30 seconds	Night stars, Milky Way (complete darkness).

**PRO TIP:** To reduce blur when using Night and Night Lapse photo, mount your camera on a tripod or place it on a stable surface where it won't wobble or shake.

### BURST RATE

Capture fast-action scenes with one of these high-speed settings:

- Auto (up to 30 photos in 1 second based on lighting conditions)
- 60 photos in 6 or 10 seconds
- 30 photos in 1, 3, or 6 seconds
- 10 photos in 1 or 3 seconds
- 5 photos in 1 second
- 3 photos in 1 second

## Tech Specs: Photo

---

### DIGITAL LENSES (PHOTO)

Digital lenses let you choose how much of the scene is captured by your camera. They also affect the zoom level and fisheye effect in your shot. There are three lens options for photos:

Digital Lens	Description
Wide (16–34mm)	Wide field of view that captures as much as possible within the frame.
Linear (19–39mm)	Wide field of view without the fisheye effect of Wide.

**PRO TIP:** Use Max Lens Mod (sold separately) to boost your field of view with an ultra wide 155° digital lens—the widest ever on a HERO camera.

## Tech Specs: Photo

---

### RAW FORMAT

When this setting is turned on, all photos are saved as a .jpg image (for viewing on your camera or sharing with the GoPro Quik app) and a .gpr file.

The .gpr file is based on the Adobe® DNG format. These files can be used in Adobe Camera Raw (ACR), version 9.7 or later. You can also use Adobe Photoshop® Lightroom® CC (2015.7 release or later) and Adobe Photoshop® Lightroom® 6 (version 6.7 or later).

In Photo mode, RAW Format is available for Photo, Burst, Night, Time Lapse photo, and Night Lapse photo, with these conditions and exceptions:

- SuperPhoto must be off.
- Digital lenses must be set to Wide.
- Zoom must be off.
- RAW Format is not available for capturing continuous photos.
- For Time Lapse photo, the Interval must be at least 5 seconds.
- For Night Lapse photo, the Shutter setting must be at least 5 seconds.

---

**PRO TIP:** Photos in .gpr format are saved in the same location and with the same file name as .jpg files. To access the files, insert your SD card into a card reader and locate them with your computer's file explorer.

## Tech Specs: Time Lapse

---

### TIMEWARP VIDEO SPEED

You can increase TimeWarp video speed up to 30x to turn longer activities into shareable moments. The default setting is Auto, which automatically sets the speed for you.

You can also set the speed yourself. Use this chart to estimate the length of your videos. For example, recording at 2x speed for 4 minutes will give you about 2 minutes of TimeWarp video.

Speed	Recording Time	Video Length
2x	1 minute	30 seconds
5x	1 minute	10 seconds
10x	5 minutes	30 seconds
15x	5 minutes	20 seconds
30x	5 minutes	10 seconds

*Heads Up:* Recording times are approximate. The video length may vary depending on the movement in your shot.

Speed	Examples
2x–5x	Driving through a scenic route.
10x	Hiking and exploring.
15x–30x	Running and mountain biking.

**PRO TIP:** For the best results, leave the speed on the Auto setting when shooting footage that may get bumpy.



## Tech Specs: Time Lapse

---

### SPEED RAMP (TIMEWARP)

Tap the rear touch screen while recording TimeWarp to ramp down the speed of your video. Tap again to speed it back up. Choose the speed before recording by tapping  on the capture screen or going to the TimeWarp settings menu. There are two options:

Speed	Frames per Second	Sound
Real Speed (1x)	30 fps	On
Half Speed (0.5x slo-mo)	60 fps	Off

**PRO TIP:** You can also use the Mode button  to activate Speed Ramp. Scroll down to Shortcuts in the setting menu to set it up.

### VIDEO RESOLUTION (TIMEWARP, TIME LAPSE VIDEO)

HERO11 Black shoots TimeWarp and Time Lapse video in four resolutions:

Resolution	Aspect Ratio
5.3K	16:9
4K	16:9
4K	4:3
1080p	16:9

To learn more, see [Aspect Ratio \(Video\) \(page 128\)](#).

## Tech Specs: Time Lapse

---

### TIME LAPSE INTERVAL

The Interval sets how often your camera takes a shot in Time Lapse video and Time Lapse photo modes.

Available intervals are 0.5 (default), 1, 2, 5, 10, and 30 seconds; 1, 2, 5, and 30 minutes; and 1 hour.

Interval	Examples
0.5–2 seconds	Surfing, biking, or other sports.
2 seconds	Busy street corner.
5–10 seconds	Clouds or outdoor scenes for long durations.
10 seconds–1 minute	Art projects or other lengthy activities.
1 minute–1 hour	Construction work or other activities that take place over a very long period of time.

## Tech Specs: Time Lapse

---

### Time Lapse Video Recording Time

Use this chart to determine the length of your videos.

Interval	Recording Time	Video Length
0.5 second	5 minutes	20 seconds
1 second	5 minutes	10 seconds
2 seconds	10 minutes	10 seconds
5 seconds	1 hour	20 seconds
10 seconds	1 hour	10 seconds
30 seconds	5 hours	20 seconds
1 minute	5 hours	10 seconds
2 minutes	5 hours	5 seconds
5 minutes	10 hours	4 seconds
30 minutes	1 week	10 seconds
1 hour	1 week	5 seconds

**PRO TIP:** For the best results, mount your camera on a tripod or place it on a stable surface where it won't wobble or shake. Use TimeWarp video to capture time lapse video when you're on the move.

## Tech Specs: Time Lapse

---

### NIGHT LAPSE INTERVAL

Choose how often your GoPro snaps a shot in Night Lapse mode. Night Lapse intervals are Auto; 4, 5, 10, 15, 20, and 30 seconds; and 1, 2, 5, 30, and 60 minutes.

Auto (default) syncs the Interval with the Shutter setting. If the shutter speed is set to 10 seconds and the Interval is set to Auto, your camera will take a shot every 10 seconds.

Interval	Examples
Auto	Great for all exposures (captures as quickly as possible depending on the Shutter setting).
4–5 seconds	Evening city scene, street lighting, or scenes with movement.
10–15 seconds	Dim lighting with slow scene changes, such as night clouds with a bright moon.
20–30 seconds	Very low light or very slow scene changes, like stars with minimal ambient or street light.

## Tech Specs: Time Lapse

---

### NIGHT LAPSE INTERVAL

Choose how often your GoPro snaps a shot in Night Lapse mode. Night Lapse intervals are Auto; 4, 5, 10, 15, 20, and 30 seconds; and 1, 2, 5, 30, and 60 minutes.

Auto (default) syncs the Interval with the Shutter setting. If the shutter speed is set to 10 seconds and the Interval is set to Auto, your camera will take a shot every 10 seconds.

Interval	Examples
Auto	Great for all exposures (captures as quickly as possible depending on the Shutter setting).
4–5 seconds	Evening city scene, street lighting, or scenes with movement.
10–15 seconds	Dim lighting with slow scene changes, such as night clouds with a bright moon.
20–30 seconds	Very low light or very slow scene changes, like stars with minimal ambient or street light.

## Tech Specs: Protune

---

Protune unlocks your camera's full creative potential by giving you manual control of advanced settings, including Color, White Balance, and Shutter Speed. It's compatible with professional color correction tools and other editing software.

Here are some things to keep in mind:

- Protune is available for all modes except Looping. Scroll down in the settings menu to see all of the Protune settings.
- Some Protune settings are not available when you use Exposure Control.
- Changes to Protune settings in one preset apply only to that preset. For example, changing the White Balance for Time Lapse does not affect White Balance for Burst photos.

---

**PRO TIP:** You can restore all Protune settings to their defaults by tapping  in the settings menu.

### 10-BIT HEVC

10-bit video can display over 1 billion colors for enhanced color depth in your footage. Turn this setting on to save your videos in the 10-bit HEVC format.

*Heads Up:* Be sure that your devices are capable of playing back 10-bit HEVC content before using this setting.

### BIT RATE

Bit rate determines the amount of data used to record a second of video. Choose between standard or high.

Bit Rate	Description
Standard (default)	Use a lower bit rate to minimize file sizes.
High	Use higher bit rates up to 120Mbps (5.3K and 4K video) for optimal image quality.

## Tech Specs: Protune

---

### COLOR

Color lets you adjust the color profile of your videos or photos. Scroll between the options to see a live preview of each setting, and then tap the one you want.

Color Setting	Description
Natural (default)	Captures photos and videos with a true-to-life color profile.
Vibrant	Captures photos and videos with a color-saturated profile.
Flat	Provides neutral color profile that can be color-corrected to better match footage captured with other equipment, offering more flexibility in post-production. Due to its long curve, Flat captures more details in shadows and highlights.

### WHITE BALANCE

White Balance lets you adjust the color temperature of videos and photos to optimize for cool or warm lighting conditions. Scroll between the options to see a live preview of each setting, and then tap the one you want.

Options for this setting are Auto (default), 2300K, 2800K, 3200K, 4000K, 4500K, 5000K, 5500K, 6000K, 6500K, and Native. Lower values will give you warmer tones.

You can also choose Auto to let your GoPro set the White Balance or the Native setting to create a minimally color-corrected file that allows for more precise adjustments in post-production.

## Tech Specs: Protune

---

### ISO MINIMUM/MAXIMUM

ISO Minimum and ISO Maximum let you set a range for the camera's sensitivity to light and image noise. Image noise refers to the degree of graininess in the shot.

In low light, higher ISO values result in brighter images but with more image noise. Lower values result in darker images with less image noise. Scroll between the options to see a live preview of each setting, and then tap the one you want.

The default for ISO Maximum is 1600 for video and 3200 for photos. The default for ISO Minimum is 100.

ISO Maximum and Minimum can also be set to Auto when recording video. This is especially useful when shooting in environments with fluctuating lighting conditions

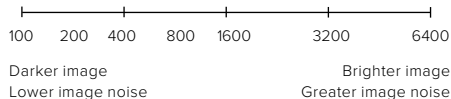

*Heads Up:* For the Video and Photo modes, ISO behavior depends on the Protune Shutter setting. The ISO Maximum that you select is used as the maximum ISO value. The ISO value that is applied might be lower depending on the lighting conditions.

**PRO TIP:** To lock the ISO at a specific value, set ISO Minimum and ISO Maximum to the same values.

## Tech Specs: Protune

---

### SHUTTER

The Protune Shutter setting only applies to the Video and Photo modes. This setting determines how long the shutter stays open. Scroll between the options to see a live preview of each setting, and then tap the one you want. The default setting is Auto.

For Photo, the options are Auto, 1/125, 1/250, 1/500, 1/1000, and 1/2000 second.

For Video, the options depend on the fps setting, as shown below.

Shutter	Example 1: 1080p30	Example 2: 1080p60
Auto	Auto	Auto
1/fps	1/30 sec	1/60 sec
1/(2xfps)	1/60 sec	1/120 sec
1/(4xfps)	1/120 sec	1/240 sec
1/(8xfps)	1/240 sec	1/480 sec
1/(16xfps)	1/480 sec	1/960 sec

**PRO TIP:** To reduce the amount of blur in videos and photos when using the Shutter setting, mount your camera on a tripod or other stable surface where it won't wobble or shake.

## Tech Specs: Protune

---

### EXPOSURE VALUE COMPENSATION (EV COMP)

Exposure Value Compensation affects the brightness of your photos and videos. Adjusting this setting can improve image quality when shooting scenes with sharply contrasting lighting conditions.

Options for this setting range from -2.0 to +2.0. The default setting is -05.

Scroll between the options on the right side of the EV Comp screen to see a live preview of each setting, and then tap the one you want. Higher values result in brighter images.

*Heads Up:* For Video, this setting is available only if Shutter is set to Auto.

You can also adjust the exposure based on a certain area of your scene. To learn more, see [Exposure Control \(page 80\)](#).

---

**PRO TIP:** EV Comp adjusts brightness within the existing ISO setting. If brightness has already reached the ISO setting in a low-light environment, increasing the EV Comp does not have any effect. To continue increasing the brightness, select a higher ISO value.

## Tech Specs: Protune

---

### SHARPNESS

Sharpness controls the quality of details captured in your video footage or photos. Options for this setting are High, Medium (default), and Low.

Scroll between the options to see a live preview of each setting, and then tap the one you want.

---

**PRO TIP:** If you plan to increase sharpness during editing, select Low for this setting.

## Tech Specs: Protune

---

### RAW AUDIO

This setting creates a separate .wav file for your video, in addition to the standard .mp4 audio track. You can select the level of processing to apply to the RAW audio track.

RAW Setting	Description
Off (default)	No separate .wav file is created.
Low	Applies minimal processing. Ideal if you want to apply audio processing in post-production.
Med	Applies moderate processing based on the Wind-Noise Reduction setting. Ideal if you want to apply your own gain.
High	Applies full audio processing (automatic gain and Wind-Noise Reduction). Ideal if you want processed audio without AAC encoding.

Insert your SD card into a card reader to access the .wav files with your computer. They're saved with the same name and in the same location as the .mp4 files.

## Tech Specs: Protune

---

### WIND-NOISE REDUCTION

Your HERO11 Black uses three microphones to capture sound while recording video. You can customize how they're used based on conditions where you're shooting and the type of sound you want in your finished video.

Setting	Description
Auto (default)	Automatically filters out excessive wind (and water) noise.
On	Use to filter out excessive wind noise or when your GoPro is mounted on a moving vehicle.
Off	Use when wind will not affect sound quality and you want to ensure that your GoPro is recording in stereo.

## Customer Support

---

GoPro is dedicated to providing the best possible service. To reach GoPro Customer Support, visit [gopro.com/help](https://gopro.com/help).

## Trademarks

---

GoPro, HERO and their respective logos are trademarks or registered trademarks of GoPro, Inc. in the United States and other countries.

© 2022 GoPro, Inc. All rights reserved. For patent information, visit [gopro.com/patents](https://gopro.com/patents). GoPro, Inc., 3025 Clearview Way, San Mateo CA 94402 | GoPro GmbH, Baierbrunner Str. 15 Bldg. D, 81379 Munich, Germany

## Regulatory Information

---

To see the complete list of country certifications, refer to the Important Product + Safety Instructions included with your camera or visit [gopro.com/help](https://gopro.com/help).

