



41-400

Tilstedeværelsessensor
 Presence detector
 Präsenzmelder
 Détecteur de présence
 Närvarosensor
 Tilstedeværelsessensor

+i



2300 W	1200 VA	μ 10A	IP20	-5°C - +50°C
2-30 min.	30-2000 lux	360°	113 m ²	2,5-4 m

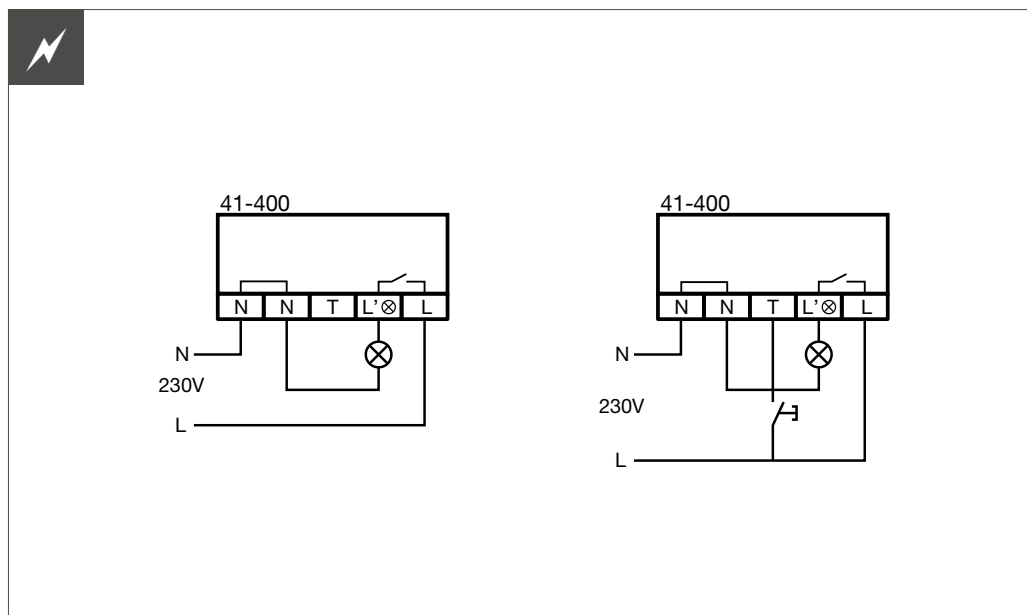
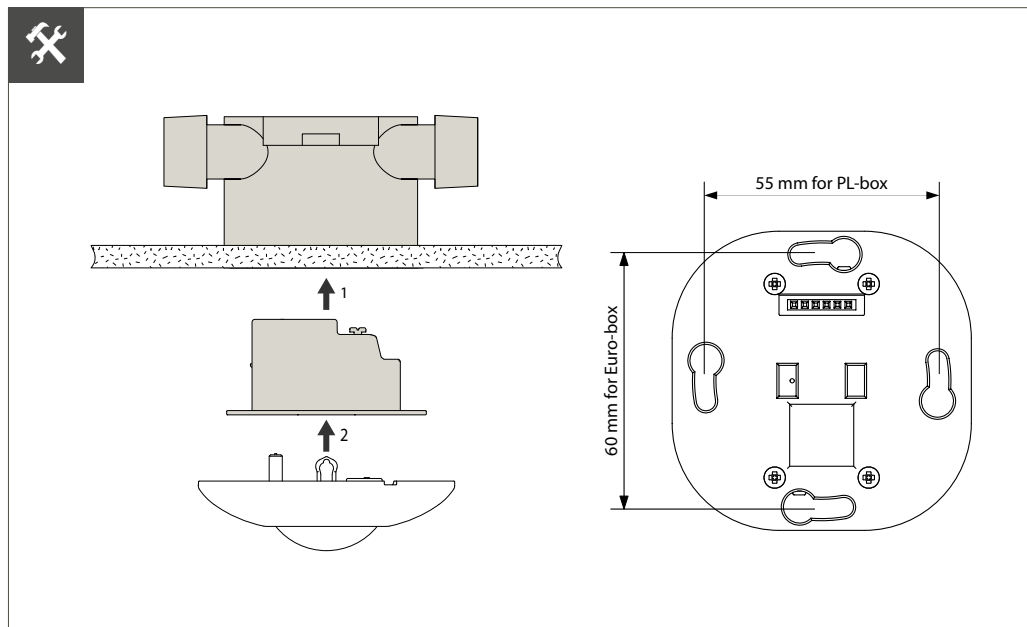
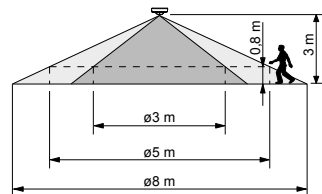
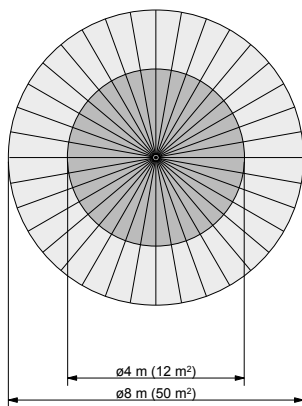
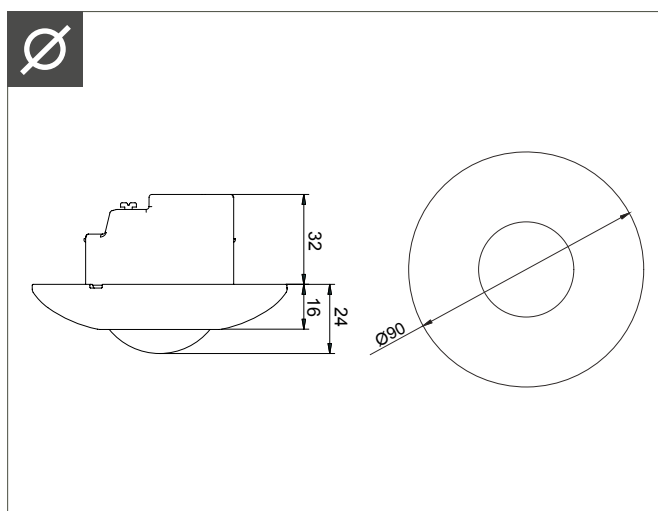

Commissioning via IR remote control 41-920



Commissioning by the Niko Sensor app using IR-dongle 41-936 for smartphone



Point towards detector





Download on the App Store

ANDROID APP ON Google play

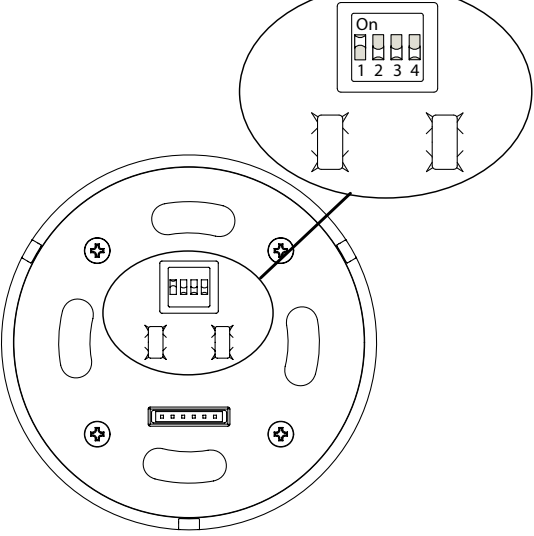
Factory setting





Legend:  = On  = Off

Sensitivity

On  Minimum
1 2 3 4

On  Low
1 2 3 4

On  High (Factory setting)
1 2 3 4

On  Maximum
1 2 3 4

Functionalities

On  **App. 1** Auto On/Off, daylight controlled (Factory setting)
1 2 3 4

On  **App. 2** Active On/Off, Auto Off, daylight controlled
1 2 3 4

On  **App. 3** Walk test for 5 min., Auto On/Off
1 2 3 4

On  **App. 4** Walk test for 5 min., Active On/Off, Auto Off
1 2 3 4

+i



For further information about programming, status and operation - Scan QR code or see www.niko.dk/produkt/41-400.

App. 1 - Auto On/Off, daylight controlled

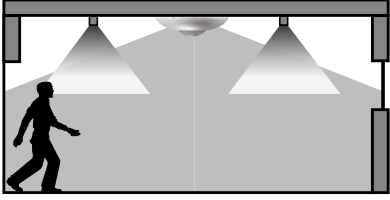

App. 2 - Active On/Off, Auto Off, daylight controlled

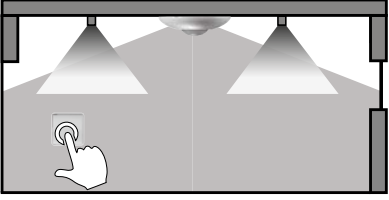

! ⚡ ⚠️ ⚡

Advarsel: Indbygning og montering af elektriske apparater må kun foretages af aut. elinstallatør. Ved fejl eller driftforstyrrelser kontakt den aut. elinstallatør. Ret til ændringer forbeholdes!

Warning: Installation and assembly of electrical equipment must be carried out by qualified electricians. Contact a qualified electrician in the event of fault or breakdown. Reserving the right to make changes!

Warnung: Einbau und Montage elektrischer Geräte dürfen nur durch Elektrofachkräfte erfolgen. Wenden Sie sich bei Störungen bzw. Ausfall an einen Elektrofach-kraft. Änderungen vorbehalten !

Avertissement: L'installation et le montage d'appareils électriques doivent exclusivement être exécutés par un électricien agréé. En cas de défaut ou de perturbation du fonctionnement, contacter un installateur électricien agréé. Sous réserve de modifications!

Varning: Elektriska apparater får endast byggas in och monteras av en auktoriserad elinstallatör. Kontakta den auktoriserade elinstallatören vid fel eller driftstörningar. Med reservation för ändringar!

Advarsel: Indbygning og montering av elektriske apparater må kun udføres av autorisert elektriker. Autorisert elektriker skal også kontaktes ved feil eller driftsforstyrrelser. Det tas forbehold om endringer.