



**!**

2300 W	1200 VA	LED 350 W	$\mu$ 10A	IP 40
1-30 min.	10-1000 lux	180°	127 m <sup>2</sup>	0,8-1,2 m
				-5°C-+50°C

## 41-203

Bevægelsessensor  
Motion detector  
Bewegungsmelder  
Détecteur de mouvements  
Rörelsesensor  
Bevegelsessensor

+i

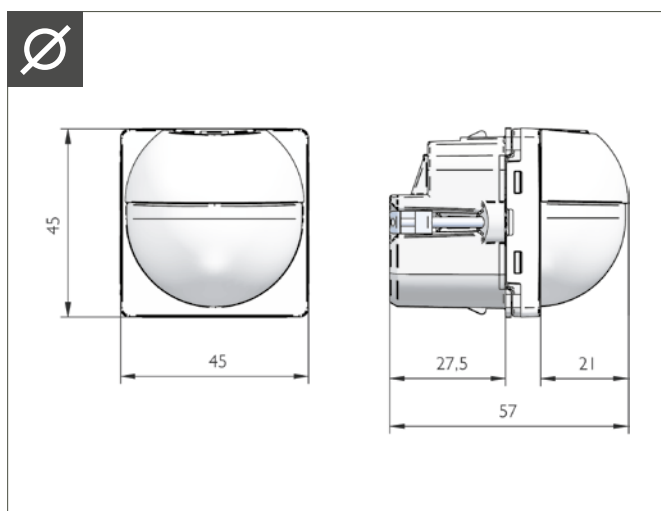

Side view

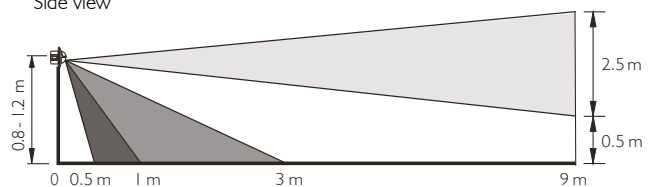

Top view  
180°

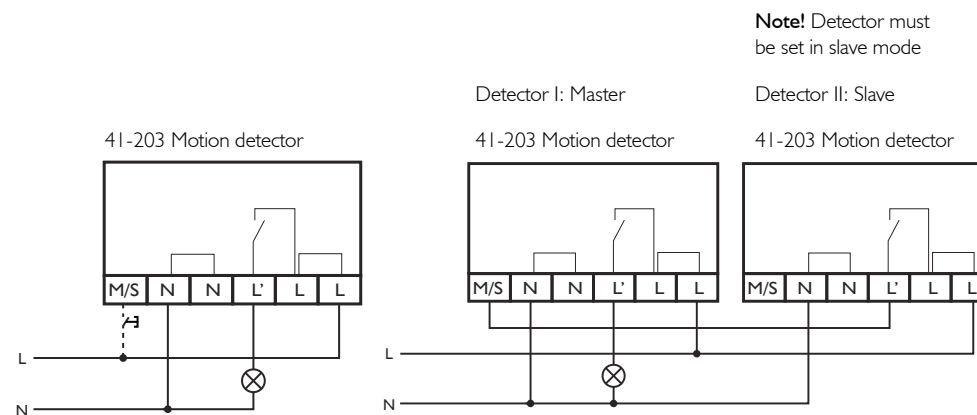
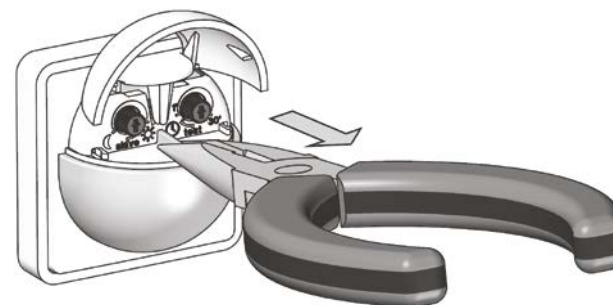



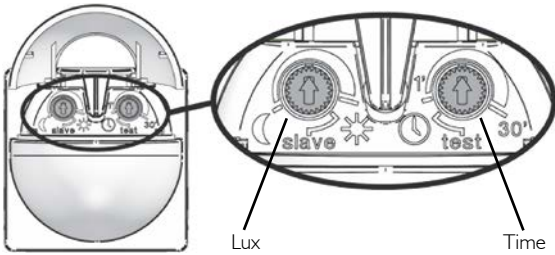

**Factory setting:**  
 Application: Auto On/Off  
 Lux: 150 lux  
 Off delay time: 5 minutes

**Settings:**

Lux	10	40	80	150	200	300	500	700	1000	No lux (slave)
Number of flashes	1	2	3	4	5	6	7	8	9	10

Time	Test	1 min.	2 min.	5 min.	10 min.	15 min.	20 min.	30 min.
Number of flashes	1	2	3	4	5	6	7	8

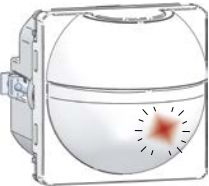

**Example:**  
 5 flashes = 200 lux  
 3 flashes = 2 min.



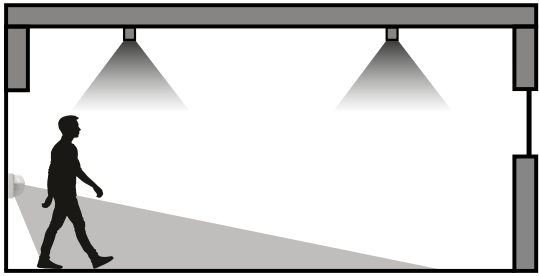

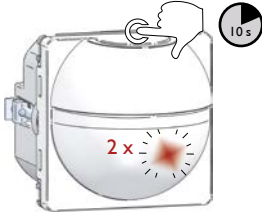
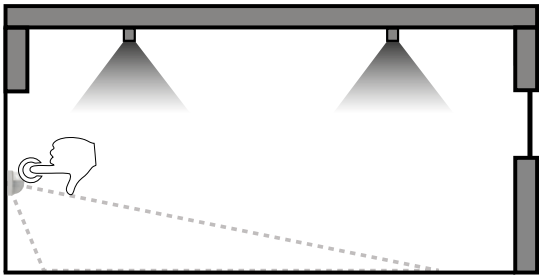

**Setting - Auto On**

**Setting - Active On**

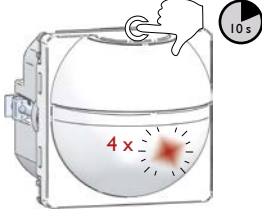





For further information about programming, status and operation - Scan QR code or see [www.niko.dk/produkt/41-203](http://www.niko.dk/produkt/41-203).





**Advarsel:** Indbygning og montering af elektriske apparater må kun foretages af aut. elinstallatør. Ved fejl eller driftforstyrrelser kontakt den aut. elinstallatør. Ret til ændringer forbeholdes!

**Warning:** Installation and assembly of electrical equipment must be carried out by qualified electricians. Contact a qualified electrician in the event of fault or breakdown. Reserving the right to make changes!

**Warnung:** Einbau und Montage elektrischer Geräte dürfen nur durch Elektrofachkräfte erfolgen. Wenden Sie sich bei Störungen bzw. Ausfall an einen Elektrofach-kraft. Änderungen vorbehalten !

**Avertissement:** L'installation et le montage d'appareils électriques doivent exclusivement être exécutés par un électricien agréé. En cas de défaut ou de perturbation du fonctionnement, contacter un installateur électricien agréé. Sous réserve de modifications!

**Warning:** Elektriska apparater får endast byggas in och monteras av en auktoriserad elinstallatör. Kontakta den auktoriserade elinstallatören vid fel eller driftstörningar. Med reservation för ändringar!

**Advarsel:** Innbygging og montering av elektriske apparater må kun utføres av autorisert elektriker. Autorisert elektriker skal også kontaktes ved feil eller driftsforstyrrelser. Det tas forbehold om endringer.