

The following features are available in this PDF document.



Quick Keyword Search

Enter the keyword in the search box and hit the search button



Quick Jump between Chapters

Click the title of a specific chapter on the Contents to jump to it

*Reading software such as Adobe Reader is needed to support the functions above.



CRANE - M2 S

User Guide

Contents

■ Product List

Product List	1
--------------	---

■ Get to Know CRANE-M2 S

Get to Know CRANE-M2 S	3
------------------------	---

■ Battery and Charging

Battery and Charging	4
----------------------	---

■ Mounting and Balancing

Mounting the Tripod	5
---------------------	---

Mounting the Camera	5
---------------------	---

Mounting the Phone	9
--------------------	---

Mounting the Action Camera	10
----------------------------	----

Balancing	10
-----------	----

■ How to Use CRANE-M2 S

Buttons Description	13
---------------------	----

Display Screen Description	14
----------------------------	----

Icon Description	15
------------------	----

Menu Option Description	16
-------------------------	----

Motor Torque Adjustment	17
-------------------------	----

Gimbal Modes Description	19
--------------------------	----

Manual Reposition	22
-------------------	----

Changing Fill Light Filters	23
-----------------------------	----

■ How to Use the App

Download the App	24
------------------	----

How to Connect	24
----------------	----

ZY Play Feature Description	25
Firmware Upgrade and Calibration	
Firmware Upgrade	26
Six-side Calibration	27
Product Specifications	
Disclaimer and Warning	
Reading Tips	31
Warnings	31
Safe Operation Guidelines	32
Warranty Terms	
Warranty Period	34
Warranty Exclusions	34
Warranty Claim Procedure	34
Contact Card	

Product List

Before using this product, please check carefully that all the following items are included in the product package. In case that any item is found missing, please contact ZHIYUN or your local selling agent.



Main Device x1

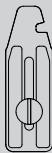

Quick Release Plate x1



Tripod x1



Fill Light Filters x4

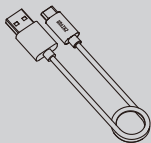

USB Type-C Cable x1

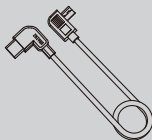
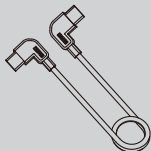
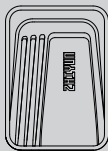
Type-C to Micro USB LN-UCMA-D02
Camera Control Cable x1Type-C to Type-C LN-UCMC-D06
Camera Control Cable x1

EPP Storage Box* x1



Phone Clamp** x1



TransMount EasyGo Backpack** x1

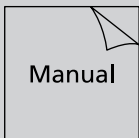

Quick Start Guide x1

Item marked “**” is included in CRANE-M2 S.

Items marked “***” are included in CRANE-M2 S COMBO.

Get to Know CRANE-M2 S

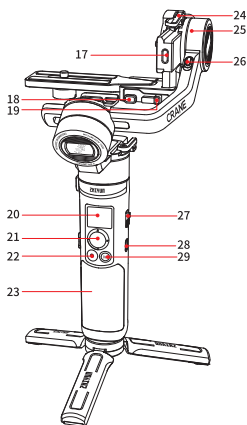
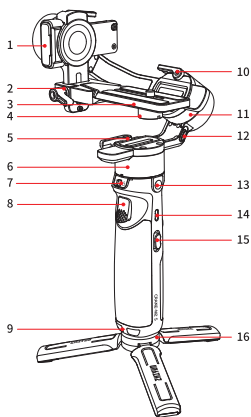

- | | |
|---|--|
| 1. Fill Light | 16. Tripod |
| 2. Level Mount Lock Screw | 17. Camera Control Port |
| 3. Quick Release Plate | 18. Quick Release Plate Release Button |
| 4. 1/4" Camera Lock Screw | 19. Quick Release Plate Safety Lock |
| 5. Pan Axis Latch | 20. Display Screen |
| 6. Pan Axis Motor | 21. Joystick |
| 7. Pan Axis Lock Switch | 22. Video Filming Button |
| 8. Trigger Button | 23. Handle |
| 9. Wrist Strap Hole | 24. Tilt Axis Latch |
| 10. Roll Axis Latch | 25. Tilt Axis Motor |
| 11. Roll Axis Motor | 26. Tilt Axis Lock Switch |
| 12. Roll Axis Lock Switch | 27. Power Button |
| 13. 1/4 Expansion Port | 28. Menu Button |
| 14. Type-C Charging/Firmware Upgrade Port | 29. M Button |
| 15. Fill Light Switch | |

Battery and Charging

CRANE-M2 S is equipped with built-in battery. When using CRANE-M2 S for the first time, please fully charge the battery to activate and to ensure the proper function of the gimbal.

Charging method: Use provided USB Type-C cable to connect the USB charger (not provided, recommend chargers that meet the USB Power Delivery Specification, supports 12W at most) to the charging port of CRANE-M2 S.

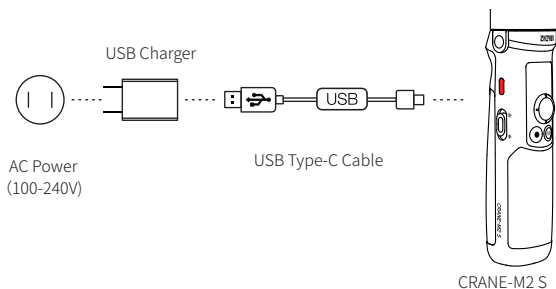

- ⚠** The gimbal is equipped with high-energy-density battery, which may cause fire, economic loss, or personal injury when not properly used and stored. Please read the disclaimer and warning herein as well as the description on the battery label carefully before using the battery.

Mounting the Tripod

Mount the tripod to the bottom of the CRANE-M2 S handle, then unfold the tripod and place the CRANE-M2 S on a flat surface.

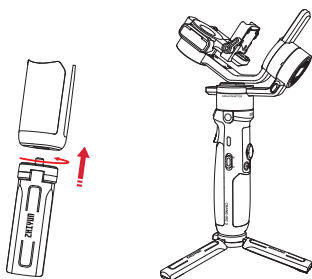

Mounting the Camera

1. Each axis of the gimbal is equipped with a lock switch. You can use these lock switches to lock the axis for convenient installation and storage. The storage state is the default state. Please toggle the lock switch to unlock the three axes, expand the gimbal as shown in the image, and lock the axes again for convenient camera installation.

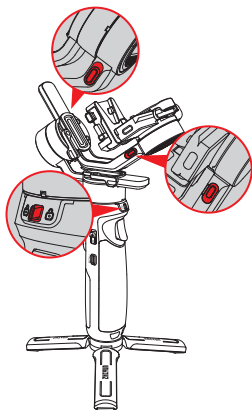

Lock state for storage

Lock state for installation

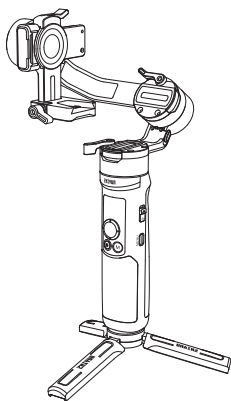

2. Mount the camera on the quick release plate. Tighten the screw.

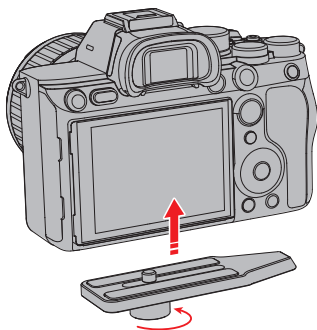

3. Toggle the quick release plate safety lock to unlock ① , install the whole quick release plate on CRANE-M2 S ② and make sure a firm installation.

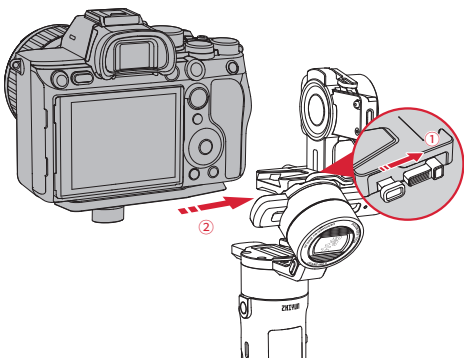

- 💡 When detaching, toggle the quick release plate safety lock to unlock ① ,press the quick release plate release button ② to push the whole quick release plate out ③ .

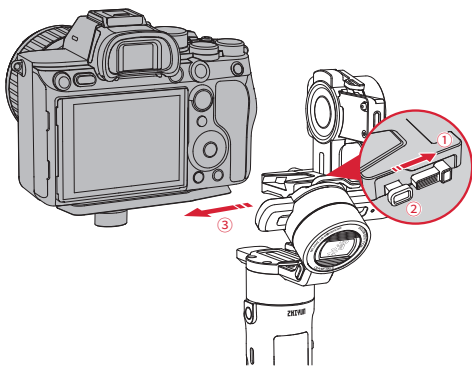

4. Connect the camera control port of the gimbal to the USB port of the camera.

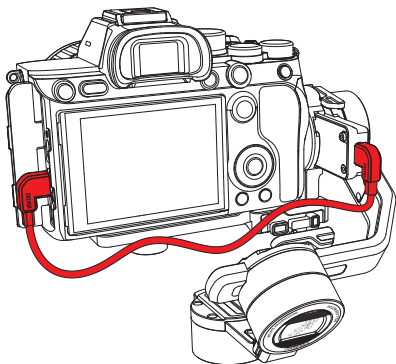

💡 Please connect with the proper cable corresponding to the USB port type of the camera. For details of the compatible camera models, please visit the official website of ZHIYUN (www.zhiyun-tech.com) and check the “CRANE-M2 S Camera Compatibility List”

Mounting the Phone

Mount the phone to the phone clamp and mount the whole phone clamp to the quick release plate. Make sure to tighten the screw.

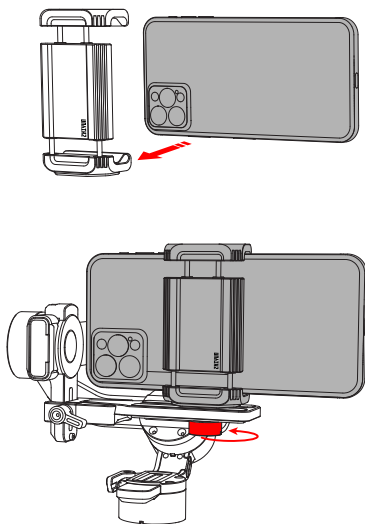

Mounting the Action Camera

Mount the action camera to the camera base (not provided) and mount the whole base to the quick release plate. Make sure to tighten the screw.

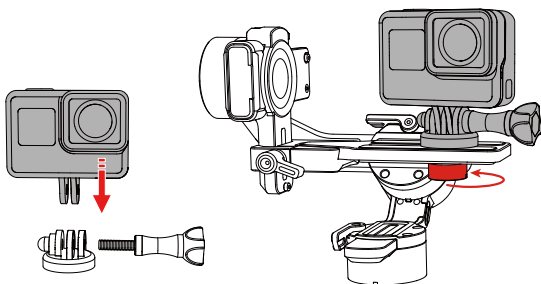

 CRANE-M2 S only provides stabilization for mobile phones and action cameras. Button controls are not supported.

Balancing

1. Horizontal Balance of the Tilt Axis

Unlock the tilt axis arm ① and loosen the tilt axis latch ②. Push the camera to move forward or backward ③ until the camera is steady and is at almost level with the ground ④. Tighten the latch ⑤.

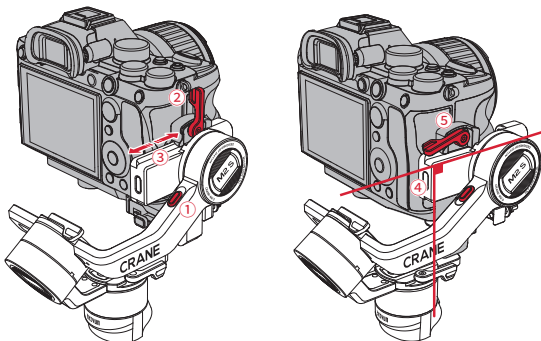

2. Vertical Balance of the Tilt Axis

Unlock the tilt axis arm, make the lens face up, loosen the level mount lock screw ① . Push the whole level mount to move forward or backward ② . Push until the camera can stay still with the lens facing up (i.e.the camera stays still and vertical to the ground) ③ . Complete this step by tightening up the screw ④ .

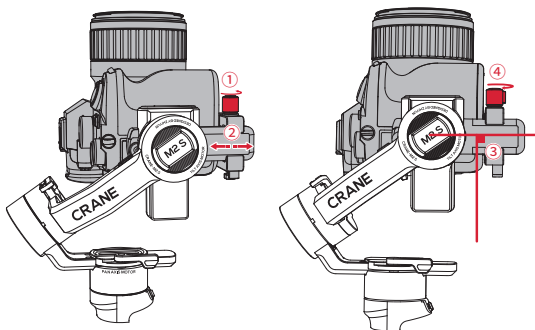

3. Roll Axis Balance

Unlock the roll axis ① , loosen the roll axis latch ② , push the roll axis arm to move left or right ③ until the camera can stay still and horizontal to the ground (as shown below) ④ . Complete this step by tightening up the latch ⑤ .

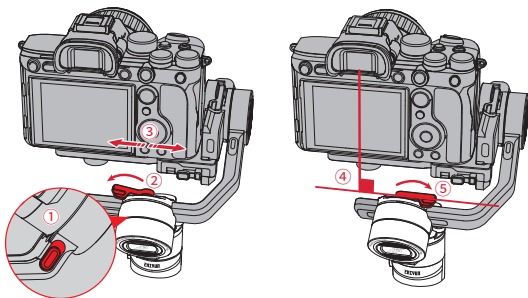

4. Pan Axis Balance



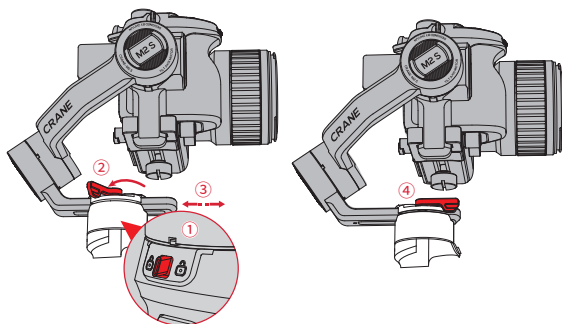

Unlock the pan axis ①, loosen the pan axis latch ②, hold and slightly tilt the handle, push the pan axis to move left or right ③ until the pan axis can stay still in any position. Complete this step by tightening up the pan axis latch ④.



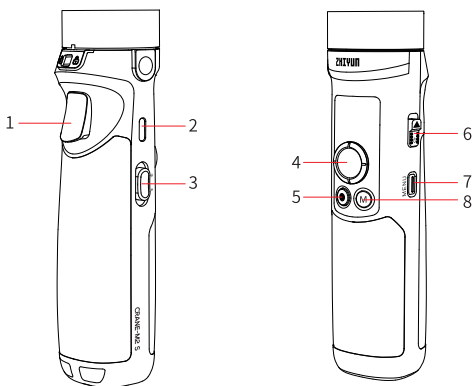



💡 After balancing CRANE-M2 S, the motor torque needs to be adjusted for proper function. For the adjustment details, please see the methods introduced in "Motor Torque Adjustment".

Buttons Description



- 1**  **Trigger Button**
 Double press: Reposition
 Triple press: 180° rotation for the pan axis motor
 Press and hold: Enter Go Mode. Release to return to the previous mode.
- 2**  **Type-C Charging/Firmware Upgrade Port**
 Charge the gimbal/connect to computer for firmware upgrade via this port.
- 3**  **Fill Light Switch**
 Toggle up/down and hold for 2 secs to turn on/off the fill light.
 Toggle up once to increase the brightness. Toggle down once to decrease the brightness.
- 4**  **Joystick**
 Control the gimbal to rotate.
 In the menu interface, push the joystick up/down to scroll up/down the menu, push left to return to the previous menu, push right to the next menu.

- 5  **Filming Button**
Single press: Start/stop the filming.
- 6  **Power Button**
Toggle up and hold for 2s to power on/off the gimbal.
- 7  **Menu Button**
Single press: Enter/exit display screen main menu.
Double press: Enable/disable gimbal joystick lock.
- 8  **M Button**
Single press: Switch gimbal modes (PF-L-F).
Double press: Switch gimbal modes (POV-V-Portrait Mode).
Single press to return to Pan Follow mode.
Press and hold: Gimbal enter/exit standby mode.

Display Screen Description



Main Page (set as default)



Standby



Axis Locked

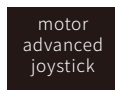







Menu



Function Icon

Icon Description

	Camera connected to gimbal
	“ZY Play” app connected to gimbal
	Joystick locked
	Current battery level/charging status
 axis lock	This icon prompts when the axis is locked and the gimbal will make a beep sound. (Please unlock the axis, press and hold the M Button to resume operation)
	Standby
PF	Pan Follow Mode
L	Lock Mode
POV	Point Of View Mode
V	Vortex Mode
F	Follow Mode
GO	Go Mode
P	Portrait Mode

Menu Option Description

motor (Motor Torque Settings)	auto (Automatic motor torque adjustment)		
	level (motor torque level)	low	
		medium	
		high	
	custom (customization)	Tilt (tilt axis)	
		Roll (roll axis)	
Pan (pan axis)			
advance (Parameter Settings)	follow (motor follow speed)	low	
		medium	
		high	
	control (joystick control speed)	low	
		medium	
		high	
	smooth (smoothness)	low	
		medium	
		high	
	default (reset to default)	yes (to confirm the reset)	
		no (to cancel the reset)	
	joystick (Joystick Settings)	reverse (control the joystick in reverse direction)	vertical (vertical)
on			
		horizontal (horizontal)	off
			on
about	Gimbal model, firmware version, Bluetooth name		

Motor Torque Adjustment

After balancing CRANE-M2 S, the motor torque needs to be adjusted for proper function. You can adjust the motor torque according to the weight of your camera and lens, so that the CRANE-M2 S can be used in its ideal state. Following are two methods for adjustment. It is recommended to use auto-calibration.

1. auto: Auto calibration will adjust the motor torque according to the weight of the carried camera and lens. Select “auto” under the “motor” menu using the joystick to enter calibration. You can see the calibration progress on the screen. When a “√” mark appear on the display screen, the auto torque adjustment is completed.



- 💡 When performing auto-calibration, please make sure that the three axes are unlocked and the gimbal is straightly put on a flat surface. Please don't touch the gimbal when calibrating.

2. level: Three levels (Low/Medium/High) are provided. Select the appropriate level according to the weight of the carried camera and lens.



3. custom: You can customize the motor torque for three axis motors. Push the joystick up/down to select the axis motor you wish to customize and push to the right to enter the customization. In the customization, push the joystick up/down to customize the motor torque and push to the left to save the setting.



- ① If the motor torque is too low/high for the payload, the camera will shake and affect the gimbal performance. Please choose proper motor torque.
- ② It is recommended to use auto-calibration. If the gimbal is not yet in the ideal state after the auto-calibration, you can use the customized adjustment or choose the level of the motor torque to be high/medium/low.
- ③ When the camera lens is changed, please balance the gimbal again and adjust the motor torque with the methods above.

Gimbal Modes Description

💡 Motors circled in red are free to move in line with the movement of the gimbal handle while motors circled in grey are locked.

Pan Follow mode (PF):

The tilt axis and roll axis motors are locked, and the camera rotates with the handle while panning horizontally. Push the joystick up/down to control the tilt axis angle, and push it left/right to control the pan axis of the camera.

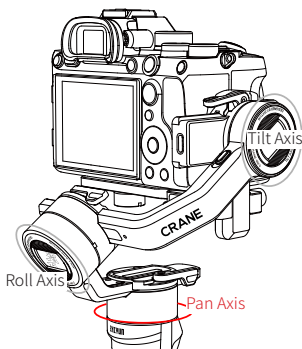

Lock mode (L):

All three motor angles are locked, and the camera orientation will not move with the rotation of the handle. Push the joystick up/down to change the tilt angle of the camera and left/right to change the horizontal orientation of the camera.

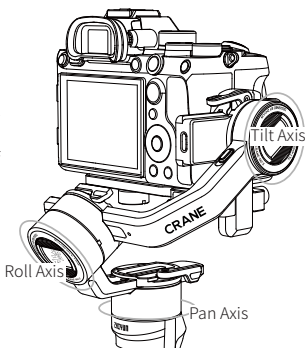

Follow mode (F):

The roll axis motor is locked, and the tilt axis and pan axis motors follow the rotation of the handle. Push the joystick up/down to change the tilt angle of the camera and left/right to change the horizontal orientation of the camera.

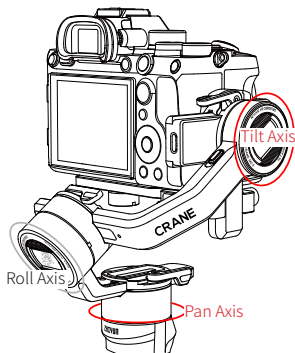

Point of View mode (POV):

All three motors move when the handle is rotated.

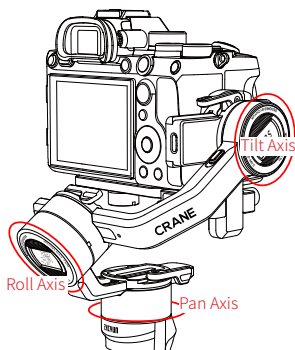

Vortex mode (V):

The tilt axis motor rotates upward by 90°, and the tilt axis, roll axis, and pan axis motors follow the rotation of the handle. Push the joystick to the left/right to control the rotation of the pan axis.

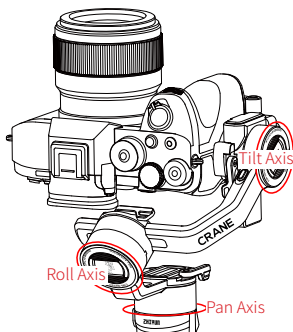

Go mode (GO):

The roll axis motor is locked, and the tilt axis and pan axis motors quickly follow the rotation of the handle.

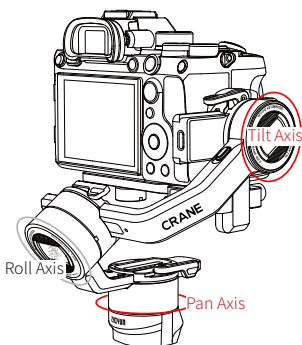

Portrait mode (P):

The tilt axis motor rotates upward by 90° and the pan axis rotates by 90° . You can enter this mode for vertical shooting.

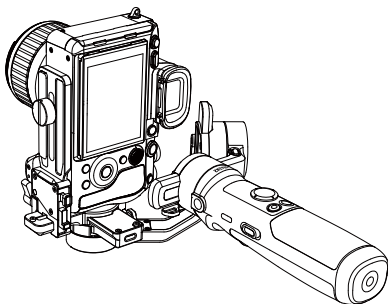

Manual Reposition

In Pan Follow mode (PF) and Lock mode (L), the camera can be rotated by a certain angle by hand. Hold it for 2s and the camera angle will be fixed at that angle after you release the camera.

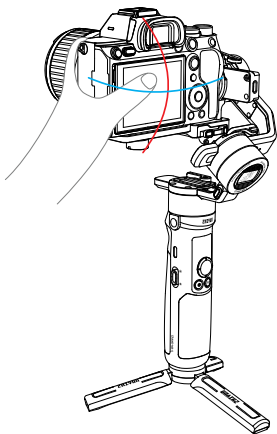

Changing Fill Light Filters

The fill light filters for CRANE-M2 S are magnetic and easy to detach. There are four colors for the filters: red, yellow, blue, and orange. You can change your fill light filters according to your actual filming scenarios.

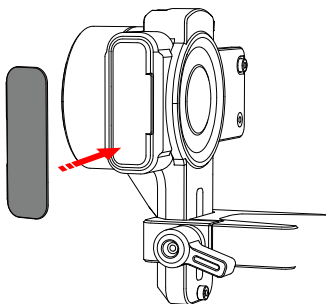

Download the App



Scan the QR code on the left (Android 5.0 and above, iOS 9.0 and above required) or search "ZY Play" in App Store or Google Play to download.

- ① "ZY Play" is an app dedicated to CRANE-M2 S. When activated CRANE-M2 S via "ZY Play", you can also use it for firmware upgrade, virtual joystick control, six-side calibration, etc.
- ② ZY Play is subject to updates without notice. Please always refer to the latest version.

How to Connect

1. Power on CRANE-M2 S and turn on Bluetooth on the smartphone.
2. Launch the "ZY Play" app. Select the CRANE-M2 S page and tap to connect. Select the Bluetooth name of your CRANE-M2 S to connect (the CRANE-M2 S Bluetooth name can be found on the side of the tilt axis USER ID: XXXX).
3. If the CRANE-M2 S is being used for the first time, you need to activate the gimbal via "ZY Play" to use the advanced features in the app. Internet connection is required.
4. After the activation succeeds, you can enter the feature interface of ZY Play App

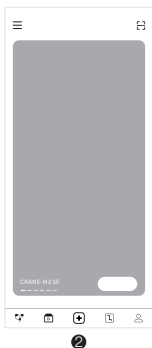
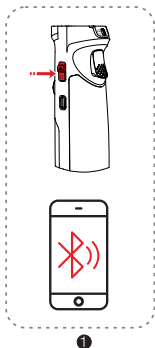

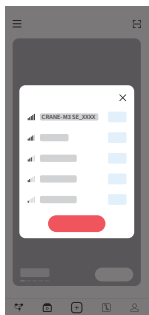

3

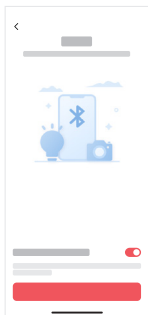

4

ZY Play Feature Description



💡 For more details of the “ZY Play” app features, please visit the official website of ZHIYUN (www.zhiyun-tech.com) and watch CRANE-M2 S video tutorials.

Firmware Upgrade

You can use "Zhiyun Gimbal Tools" or "ZY Play" App to upgrade the firmware of CRANE-M2 S.

Method 1:

1. Connect the Type-C charging/firmware upgrade port to the computer with the USB Type-C cable, power on CRANE-M2 S, and enter standby mode.
2. Visit the official website of ZHIYUN (www.zhiyun-tech.com), go to the CRANE-M2 S product page, click "Download", find the USB driver, the ZHIYUN calibration upgrade tool and the firmware and download. (USB drivers are not required for Mac OS systems)
3. Install the driver and the software, unzip the firmware for the files with the ".ptz" file extension.
4. Open "Zhiyun Gimbal Tools", select the corresponding port, click "Open", click "Firmware Upgrade". Click "Browse" under "Path" to select the latest firmware downloaded (with the ".ptz" file extension), and click "Upgrade" at the bottom to upgrade firmware. When the firmware upgrade finishes, CRANE-M2 S will be automatically turned off.

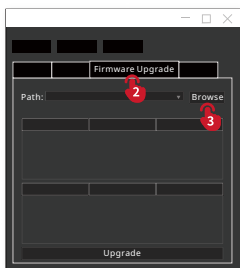
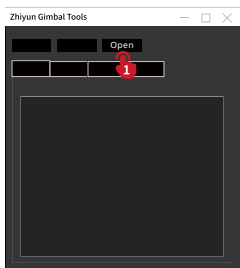
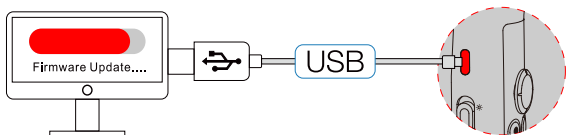

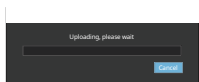
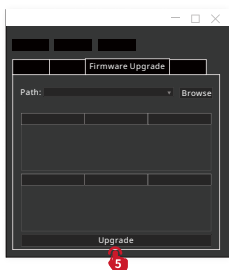
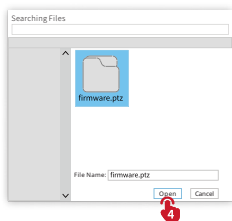

Method 2 : Connect CRANE-M2 S to the “ZY Play” app. If “ZY Play” app prompts to upgrade the firmware, follow the instructions to upgrade. Internet connection is required.

- ⚡ Before upgrading the firmware, please ensure that the CRANE-M2 S has more than 50% power remaining. Do not exit the app interface or access in the background during the upgrading process. Pay attention to the prompts on the app.

Six-side Calibration

Calibration Reason	How to calibrate
<ol style="list-style-type: none"> 1. Slight deviation is found in the level position after the initialization of the gimbal. 2. The gimbal has not been used for a long time. 3. The gimbal undergoes significant temperature differences in operation environments. 	Six-side Calibration

Method 1: Six-side calibration via APP:

According to the method introduced in "How to Use the App", please connect the gimbal to the APP, and enter "Settings" - "Six-side Calibration", then conduct the six-side calibration according to the prompt.

Method 2: Six-side calibration via "Zhiyun Gimbal Tools":

Power on the gimbal and enter standby mode. Connect the charging/firmware upgrade port of the gimbal to the computer with the Type-C USB cable, Open "Zhiyun Gimbal Tools", click "open" on the top and click "calibration" on the bottom. Please conduct the process according to the following steps. A "√" mark will appear after the calibration is complete.

- 💡 ① Please refer to the six-side calibration steps below. After the calibration completes, please restart the gimbal.
- ② In simple terms, six-side calibration is to place all six sides of the tilt axis in vertical to a level surface respectively.

STEP 1

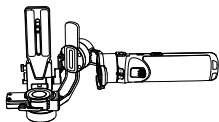

STEP 2



STEP 3

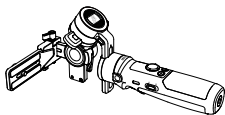

STEP 4

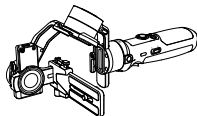

STEP 5

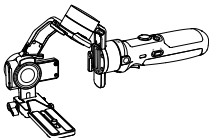

STEP 6

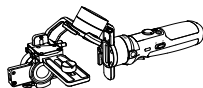

Product Model: CR123

	Min.	Standard	Max.	Remark
Operation Voltage	9.6V	11.1V	12.6V	
Operation Current	135mA	-	4000mA	
Output Voltage (Camera Control Port)	-	5V	-	
Output Current (Camera Control Port)	-	1A	1.2A	
Tilt Mechanical Range	-	320°	-	
Roll Mechanical Range	-	320°	-	
Pan Mechanical Range	-	360°	-	
Controllable Tilt Angle	-60°	-	+160°	
Controllable Roll Angle	-30°	-	+30°	
Controllable Pan Angle	-	360°	-	Unlimited Rotation
Operation Temperature	-10°	25°	50°	
Battery Capacity	-	1150mAh	-	
Battery Runtime	-	10H35min	-	Lab Data 1
Charging Time	-	1H41min	-	Lab Data 2
Gimbal Net Weight	-	≈ 548g	-	
Quick Release Plate Weight	-	≈ 41g	-	
Tripod Weight	-	≈ 53g	-	
Gimbal Size (Folded)	-	≈ 235*148*69mm	-	Without tripod (W*D*H)
Gimbal Size (Expanded)	-	≈ 261.4*123.25*108mm	-	Without tripod (W*D*H)

	Min.	Standard	Max.	Remark
Bluetooth	-	Bluetooth 5.0	-	
EIRP	-	<10dBm	-	
Operation Frequency	-	2.4GHz	-	
Camera Charging	-	Able to charge for 5V / 1A cameras	-	
1/4" Rosette Mount Screw Thread Carry Weight	-	Carry weight \leq 1000g, Arm \leq 100mm	-	
Display Screen Size	-	0.66inch	-	

Lab Data 1: The above data is collected at a specified temperature of 25°C . The CRANE-M2 S is fully charged with 1150mAh battery and mounted with SONY A7C+ SONY E F4 10-18mm oss and properly balanced. When the gimbal is put on a flat surface and the screen is on, the maximum runtime is 10h 43min.

Lab Data 2: This test is conducted with a 9V-12W PD fast charge at a specified temperature of 25°C . The charging time is 1h41min. The actual charging time varies with environmental factors. In addition, the lower the temperature, the longer the charging time.

All the data in this guide is collected from internal experiments of ZHIYUN laboratories. Under different scenarios, the above data is subject to a margin of error. Please refer to the actual use of this product.

Thank you for purchasing CRANE-M2 S. The information contains herein affects your safety, legitimate rights and obligation. Please read this instruction carefully to ensure proper configuration before use. Failure to read and follow this instruction and warnings herein may result in serious injury to you or bystanders, or damage to your device or property. Guilin Zhishen Information Technology Co., Ltd (hereinafter referred to as "ZHIYUN") reserves all rights for final explanation on this instruction and other documents related to CRANE-M2 S. The information is subject to update without notice. Please visit www.zhiyun-tech.com to obtain the latest product information.

By using this product, you hereby signify that you have read this document carefully and that you understand and agree to abide by the terms and conditions herein. You agree that you are solely responsible for your own conduct while using this product, and for any consequences thereof. You agree to use this product only for purposes that are proper and in accordance with all terms, precautions, practices, policies and guidelines ZHIYUN has made and may make available.

ZHIYUN accepts no liability for damage, injury or any legal responsibility incurred directly or indirectly from the use of this product. Users shall observe safe and lawful practices including, but not limited to, those set forth herein.

ZHIYUN™, TransMount™ are the trademark of Guilin Zhishen Information Technology Co., Ltd and its affiliates. All product names or trademarks referred to herein are trademarks or registered trademarks of their respective holders.

Reading Tips

Legends:  Hints and Tips  Important

Warnings

Read the ENTIRE User Guide to become familiar with the features of this product before operating. Failure to operate the product correctly can result in damage to the product or personal property and cause serious injury. This is a sophisticated product. It must be operated with caution and common sense and requires some basic mechanical ability. Failure to operate this product in a safe and responsible manner could result in injury or damage to the product or other property. This product is not intended for use by children without direct adult supervision. DO NOT use with incompatible components or in any way otherwise as mentioned or instructed in the product documents provided by ZHIYUN. The safety guidelines herein contain instructions for safety, operation and maintenance. It is essential to read and follow all of the instructions and warnings in the User Guide, prior to assembly, setup or use, in order to operate the product correctly and avoid damage or serious injury.

Safe Operation Guidelines

CAUTION:

1. CRANE-M2 S is a high-precision control device. Damage may be caused to CRANE-M2 S if dropped or subject to external force, and this may result in malfunction.
2. Make sure the rotation of the gimbal axes is not blocked by external force when CRANE-M2 S is turned on.
3. CRANE-M2 S is not waterproof. Prevent contacts of any kind of liquid or cleaner with the CRANE-M2 S. It is recommended to use dry cloth for cleaning.
4. Protect CRANE-M2 S from dust and sand during use.

WARNING: To avoid fire, serious injury, and property damage, observe the following safety guidelines when using, charging, or storing your batteries.

1. Prevent the batteries from coming into contact with any kind of liquid. Do not leave batteries out in the rain or near a source of moisture. Do not drop the battery into water. If the inside of the battery comes into contact with water, chemical decomposition may occur, potentially resulting in the battery catching on fire, and may even lead to an explosion.
2. If the battery catches fire, use sand or dry powder fire extinguisher immediately to put out the fire.
3. Never use non-ZHIYUN batteries. If replacement or backup is needed, please purchase new batteries from ZHIYUN's official website or authorized channels. ZHIYUN takes no responsibility for any damage caused by non-ZHIYUN batteries.
4. Never use or charge swollen, leaky, or damaged batteries. Never use or charge if the battery smells, or overheats (exceeding the maximum temperature of 160 ° F/71 ° C). If your batteries are abnormal, contact ZHIYUN or a ZHIYUN authorized dealer for further assistance.
5. The battery should be used within the temperature range from -10° C to 60° C. Use of battery in environments above 60° C may lead to a fire or explosion. Use of battery below -10° C may lead to serious battery damage.
6. Do not use the battery in strong electrostatic or electromagnetic environments. Otherwise, the battery protection board may malfunction.
7. Do not disassemble or use any sharp object to puncture the battery in any way. Otherwise, the battery may leak, catch fire or explode.
8. Do not mechanically strike, crush, or throw the battery. Do not place heavy objects on the battery or charger.
9. Electrolytes inside the battery are highly corrosive. In case of accidental contact

of any electrolytes with your skin or eyes, rinse immediately with water for at least 15 minutes and seek medical advice as soon as possible.

10. Do not use the battery if it has been involved in a crash or heavy impact.
11. Do not heat the battery and never put the battery in a microwave oven or in a pressurized container.
12. Do not place the battery on a conductive surface (such as a metal desk surface, eyeglasses, watch, jewelry, etc.)
13. Prevent use of wires or other metal objects that could cause positive and negative short-circuit to the battery.

Battery Charging

1. Do not put the battery and charger near flammable materials or on flammable surfaces (such as carpet or wood). Never leave the battery unattended during charging to prevent any accident.
2. Please disconnect the battery and the charger when fully charged.
3. Do not charge the battery immediately after use, because the battery temperature may be too high. Do not charge the battery until it cools down to normal room temperature. Charging the battery with its temperature over 45° C or lower than 0° C may lead to leakage, overheating, or damage.

Battery Storage

1. Keep batteries out of the reach of children and pets.
2. Do not leave the battery near heat sources such as a furnace or heater, or inside of a vehicle on hot days. Never expose the battery in any environment with temperature of over 60° C. The ideal storage temperature is 22° C-28° C.
3. Store batteries in a dry environment.
4. Do not leave the battery unused for too long after it has been completely discharged to prevent over-discharge of battery which may result in battery damage and permanent failure.

Battery Maintenance

1. Do not over-charge or over-discharge the battery, which will damage the battery;
2. The battery performance will be affected for not being used for a long time;
3. Never use the battery when the temperature is too high or too low;
4. Do not store the battery in any environment with a temperature of over 60° C .
5. Recharge and discharge every 3 months to keep the battery active.

Battery Disposal

Please fully discharge the battery before putting it in the designated recycling bin. Batteries contain hazardous constituents and it is forbidden to put the battery in general waste bin. For related details please abide by the local laws and regulations on battery recycling and disposal.

Warranty Period

1. Customers are entitled to replacement or free repair service in case of quality deficits found in the product within 15 days upon receipt of the product.
2. Customers are entitled to free repair service from ZHIYUN for any product proven defective in material or workmanship that results in product failure during normal consumer usage and conditions within the valid warranty period, which is 12 months counting from the date of selling. However, warranty period varies by product component and country of purchase. Please contact our after-sales service team on the ZHIYUN official website or your place of purchase for detailed warranty information.

Warranty Exclusions

1. Products subjected to unauthorized repair, misuse, collision, neglect, mishandling, soaking, accident, and unauthorized alteration.
2. Products subjected to improper use or whose labels or security tags have been torn off or altered.
3. Products whose warranty has expired.
4. Products damaged due to force majeure, such as fire, flood, lightning, etc.

Warranty Claim Procedure

1. If failure or any problem occurs to your product after purchase, please contact a local agent for assistance, or you can always contact ZHIYUN's customer service through email at info@zhiyun-tech.com or website at www.zhiyun-tech.com.
2. Your local agent or ZHIYUN's customer service will guide you through the whole service procedure regarding any product issue or problem you have encountered. ZHIYUN reserves the right to reexamine damaged or returned products.

Customer information

Customer Name :

Contact No :

Address :

Sales Information

Sales Date :

Prod. Serial No :

Dealer :

Contact No ::

#1 Maintenance Record

Service Date :

Signature of Repairman :

Cause of Problem :

Service Result :

 Solved Unsolved Refunded
(Replaced)



Website



Weibo



Vimeo



Google+



Facebook
(Zhiyun Support)



Facebook
(Zhiyun Tech)



Youku



Youtube



Wechat



Instagram

Tel: +86 400 900 6868

USA Hotline: +1 808-319-6137,9:00-18:00 GMT-7,Mon-Fri

Europe Hotline: +49 (0) 61018132180,10:00-17:00 GMT+1,Mon-Fri

Web: www.zhiyun-tech.com

E-mail: info@zhiyun-tech.com

Address: 09 Huangtong Road, Tieshan Industrial Zone, Qixing District, Guilin, 541004, Guangxi, China.

Certificate of Quality

This product is confirmed to meet quality standards and permitted for sale after strict inspection.

QC Inspector: _____



Please download the latest version from www.zhiyun-tech.com

This document is subject to change without notice.

ZHIYUN™ is a trademark of ZHISHEN.

All other trademarks cited herein are the property of their respective owners.

Copyright © 2021 ZHISHEN. All rights reserved.

ZHIYUN-TECH.COM