

**ONE
FOR ALL**

ENGLISH

URC7115 SIMPLE SET UP GUIDE

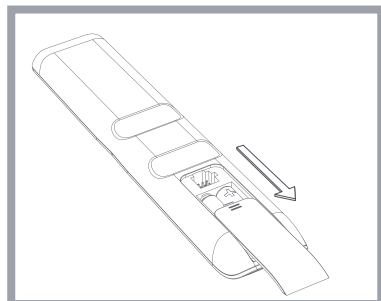

Open the battery door.

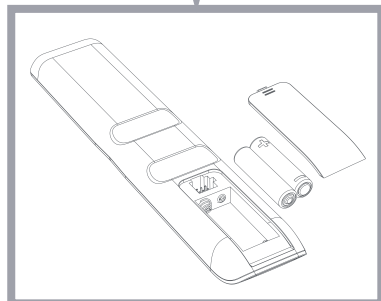

Insert 2 AAA batteries.

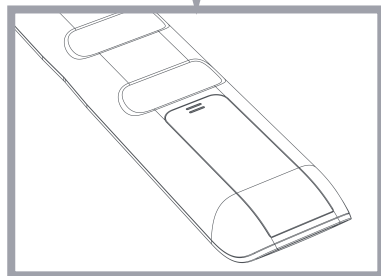

ENGLISH

KEY TABLE

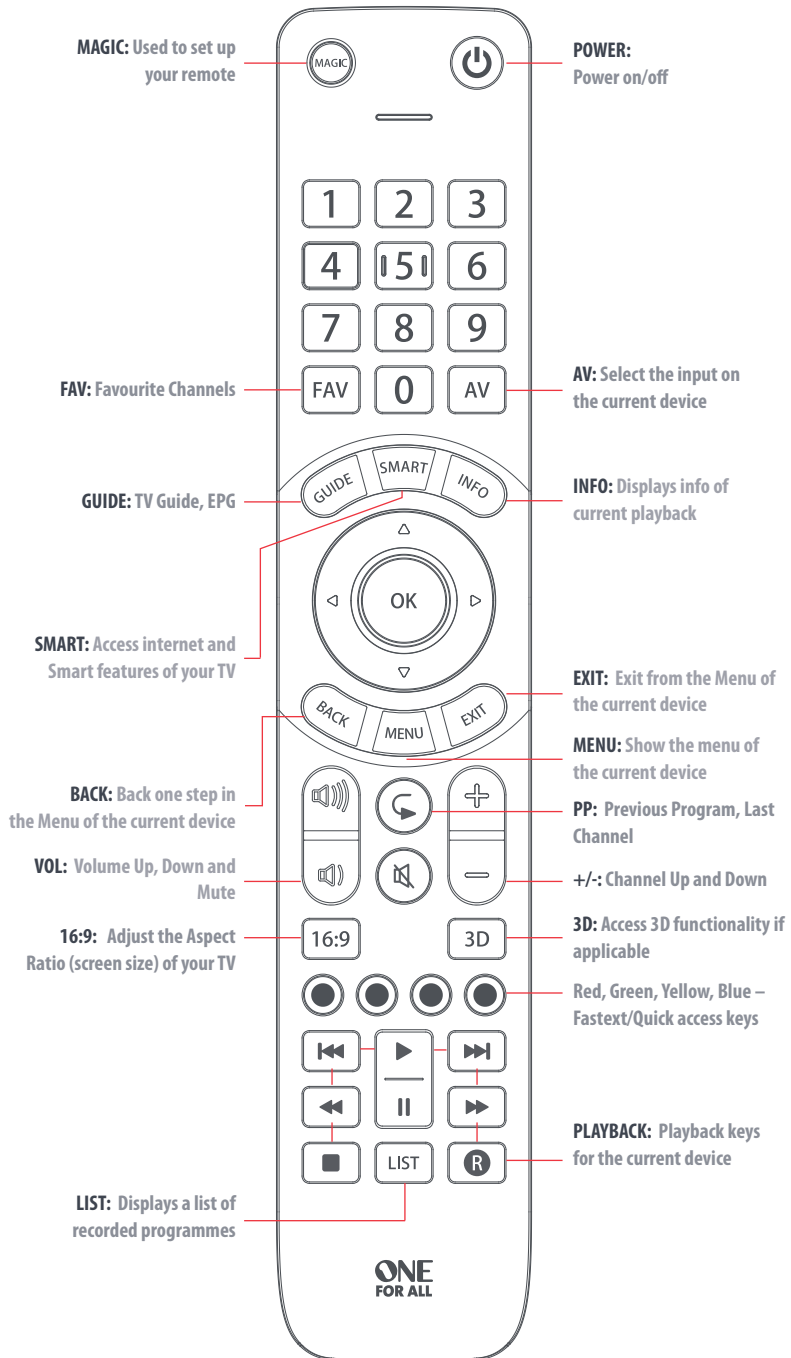

HOW TO SET UP YOUR REMOTE

A – SIMPLESET



SimpleSet is a quick and easy way of setting up the remote to control the most popular brands of each device type with only a few key presses, typically in under a minute per device.

For each Device type, there is a list of the top brands, each with a number assigned to it, for example 6 for a Samsung TV. Locate your device and brand in the list that follows:

TV

1	Alba / Bush / Goodmans	6	Samsung
2	Grundig	7	Sharp
3	LG	8	Sony
4	Panasonic	9	TCL / Thomson
5	Philips	0	Toshiba





To set up your device

1. Turn on your device (not on standby) and point the OFA remote towards it.
 2.  Hold down MAGIC until the LED blinks twice.
 3.  Hold down the digit for your brand and device as listed above (e.g. 6 for Samsung TV).
 4. The remote will send Power every 3 seconds until your device switches off.
 5. As soon as your device switches off, release the digit.
 6. The LED will blink twice and go out. The remote should now operate your device.
- If you find one or more keys do not work as you expect, start again at step 1 – the remote will start with the next code in the memory.

HOW TO SET UP YOUR REMOTE

B – SET UP BY CODE

If your brand is not listed in section A, you can set up your device by trying codes individually. To do this:

1. Turn your device on (not on standby).
 2.  Locate the brand of your device in the code list (pages 74-77). Codes are listed by Device Type.
 3.  Hold down MAGIC until the LED blinks twice.
 4.  Enter the first 4 digit code listed for your brand (e.g. 0556 for a Bennett TV).
 5. The LED will blink twice and go out.
 6.  Now aim the remote towards your device and press the POWER key.
 7. If the device turns off, your remote is ready to use. If not, repeat steps 3-6 with the next code in the list.
- Some codes are quite similar. If you find that one or more keys do not operate as you expect, try again from step 3 with the next code in the list.





LEARNING

Your One For All remote control can learn any function from any other working remote control. This can be useful if you are missing one or more functions from your original remote control and would like to add them to the ONE FOR ALL.

You can also learn a complete device if you can't find a code.

To learn, firstly make sure you have all your original remote controls to hand, and that they have working batteries in. To learn functions, the original remote should be approximately 3cm from the OFA remote, pointing towards it as shown below:



1.  Hold down MAGIC until the LED blinks twice.
2.  Press 975 – the LED will blink twice.
3.  Press and release the key you want to learn a function onto (for example the 3D key) – The red LED will blink continuously.
4.  Press and release the key on the original remote.
5. The LED will blink twice to indicate the key has been learned correctly.
6. Repeat steps 3 and 4 for each key you want to learn – remember you can learn from multiple remotes, but only one function per key.
7.  When you learned all the functions you require, press and hold the MAGIC key until the LED blinks twice and turns off.

HINTS

- If the LED shows one long blink at step 5, the function was not learned correctly, please try again from step 3.
- If you find one or more keys don't work properly after set up, you can re-enter the learning mode at any time by repeating the procedure from step 1.

TO DELETE A LEARNED FUNCTION, THE PROCEDURE IS:

1. Hold down MAGIC until the LED blinks twice.
2. Press 976 – the LED will blink twice
3. Press the key to delete twice – the LED will blink twice.

Repeat the above procedure for each key you want to delete.

PRODUCT DISPOSAL

(EUROPEAN DIRECTIVE 2002/96/EC)

The crossed out wheeled bin symbol on this product ensures that this product is manufactured using high quality components that can be recycled and reused according to European Directive 2002/96/EC. Please do not dispose this product with your normal household waste but inform yourself about the local separate collection for electrical and electronic products to dispose this product correctly. This will help preventing potential negative effects on the environment and/or human health.

BATTERY DISPOSAL and safety

(EUROPEAN DIRECTIVE 2006/66/EC)

Please do not dispose your batteries with your normal household waste but inform yourself about the local separate collection for empty batteries to dispose them correctly. This will help preventing potential negative effects on the environment and/or human health. Keep batteries away from fire, out of direct sunlight, and away from other sources of heat.

UNIVERSAL ELECTRONICS INC/ONE FOR ALL warrants to the original purchaser that this product will be free from defects in materials and workmanship under normal and correct use for a period of one (1) year from the date of original purchase. This product will be replaced free of charge if it has been proven to be defective within the one (1) year warranty period. This warranty does not cover cartons, carrying cases, batteries, broken or marred cabinets or any other item used in connection with the product. Any further obligation than listed above is excluded. Please notice that we need your purchase receipt so that we may establish your eligibility for service. If you have bought this product for purposes which are not related to your trade, business or profession, please remember that you may have legal rights under your national legislation governing the sale of consumer goods. This guarantee does not affect those rights.

UK
www.oneforall.com

Ireland
www.oneforall.com

South Africa
0861 100551
support@oneforall.co.za
www.connoisseur.co.za
www.oneforall.com

New Zealand
0800 142569
sales@amber.co.nz
www.amber.co.nz
www.oneforall.com

Australia
1 300 888 298
ofa.support@ambertech.com.au
www.ambertech.com.au
www.oneforall.com

Universal Electronics BV
Europe & International
Colosseum 2, 7521 PT Enschede
The Netherlands



URC7115
710797
RDN-1020616