



# IceSLEET™ X6

---

Quick Start Guide

[Iceberg-Thermal.com](http://Iceberg-Thermal.com)

# Box Content

A

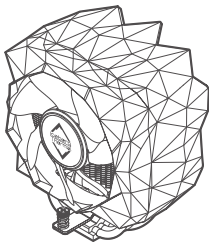

x1

B



x4

C



x1

AMD

D



x4

E



x4

F

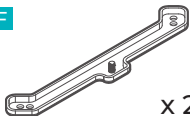

x2

INTEL

G



x4

H

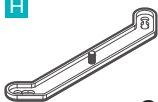

x2

I



x4

J

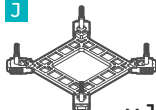

x1

# AMD

## AM4

**B**



**F**

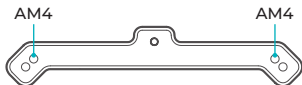

**D**

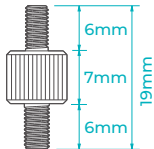

## AM3(+)/AM2(+)/FM2(+)/FM1

**B**



**F**

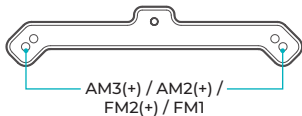

**E**

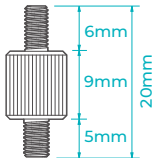

# AMD

## AM4

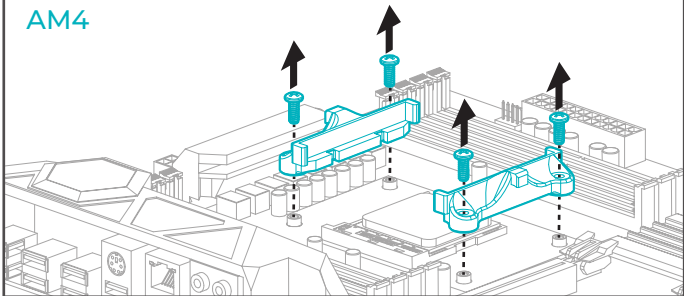

## AM3(+) / AM2(+) / FM2(+) / FM1

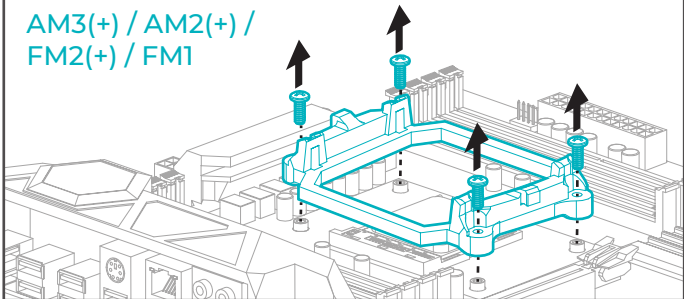

AMD

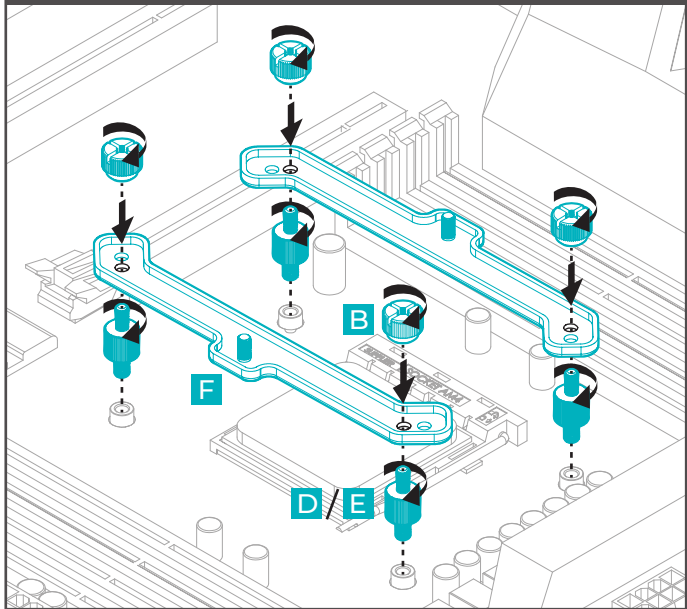

# INTEL

## LGA 2066 / 2011-0 / 2011-3 (Square ILM)

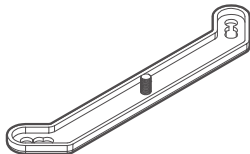
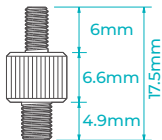
**B****H****G**

## LGA 1200 / 115X / 1366 / 775

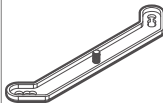
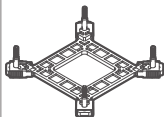
**B****H****I****J**

# INTEL

## H

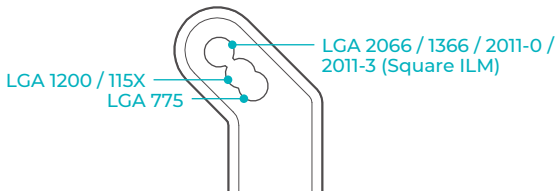

## J

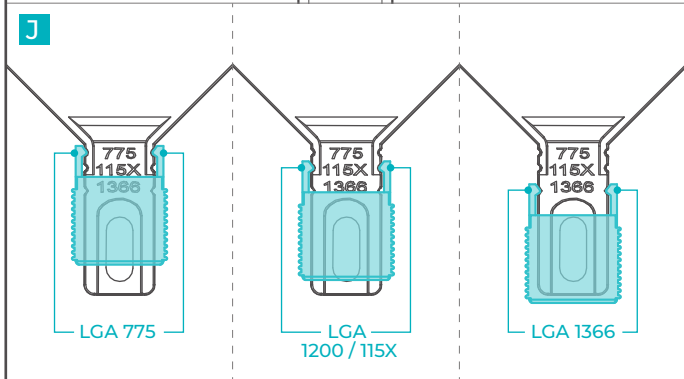

INTEL

LGA 2066 / 2011-0 / 2011-3 (Square ILM)

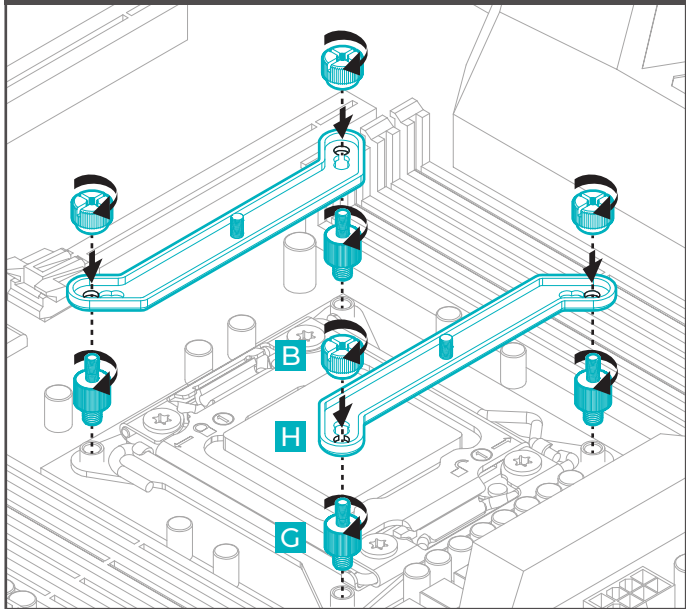



INTEL

LGA 1200 / 115X / 1366 / 775

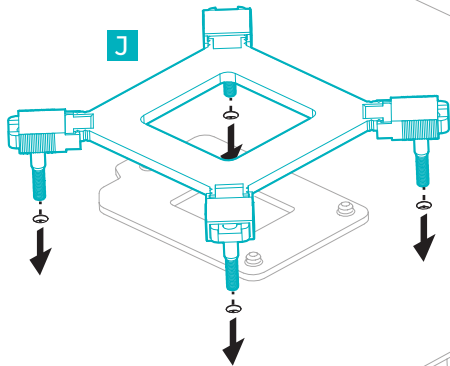

INTEL

LGA 1200 / 115X / 1366 / 775

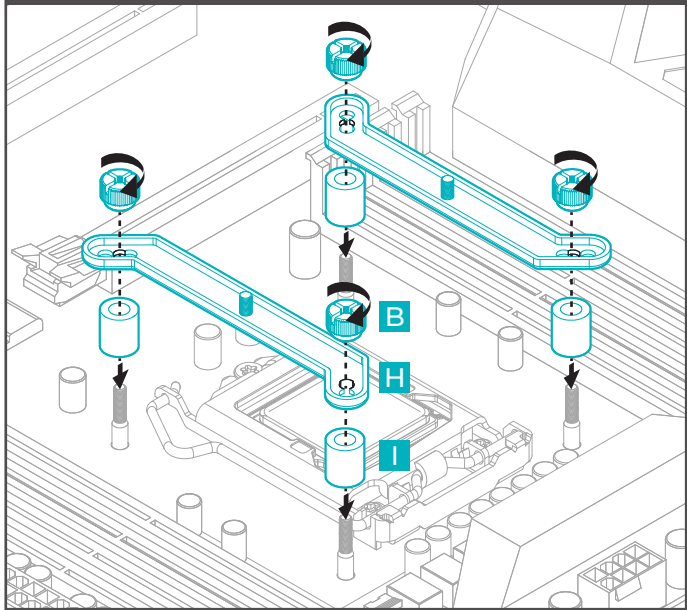

Step 1

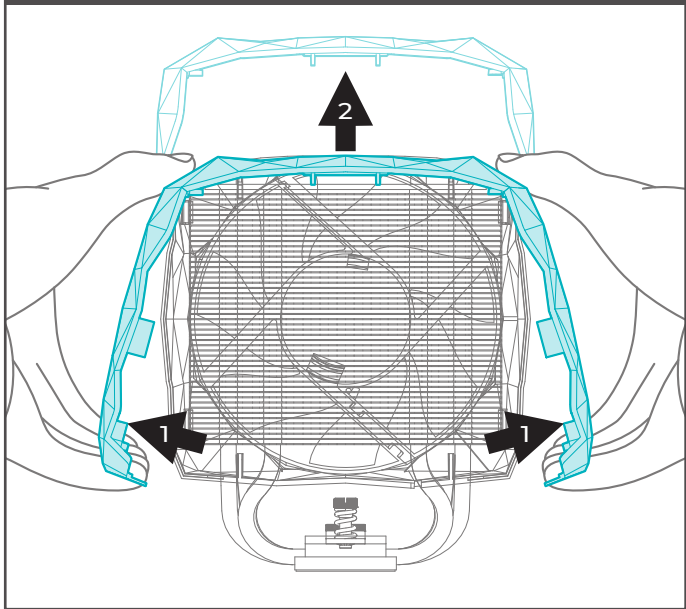

Step 2

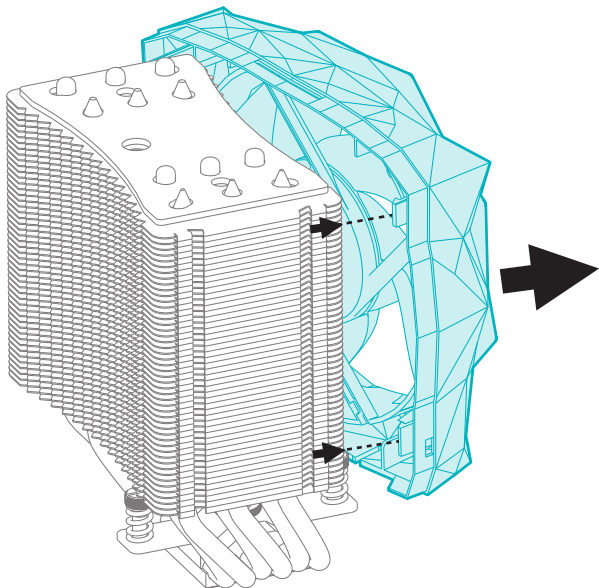

## Step 3

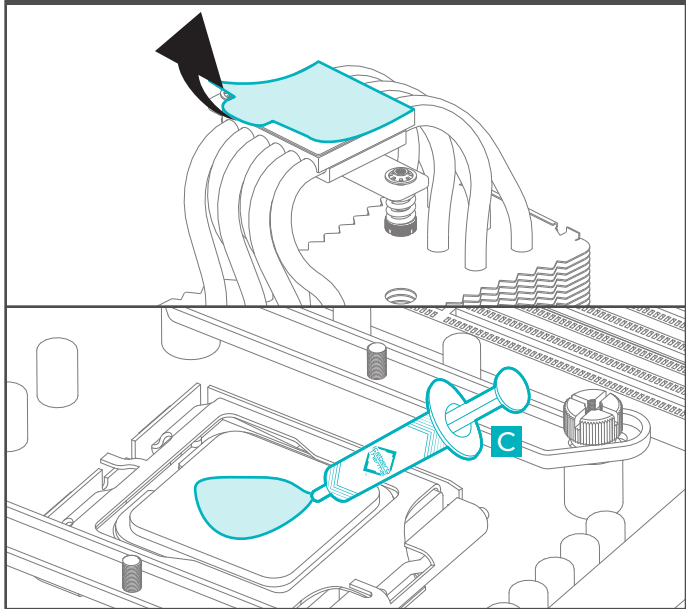

Step 4

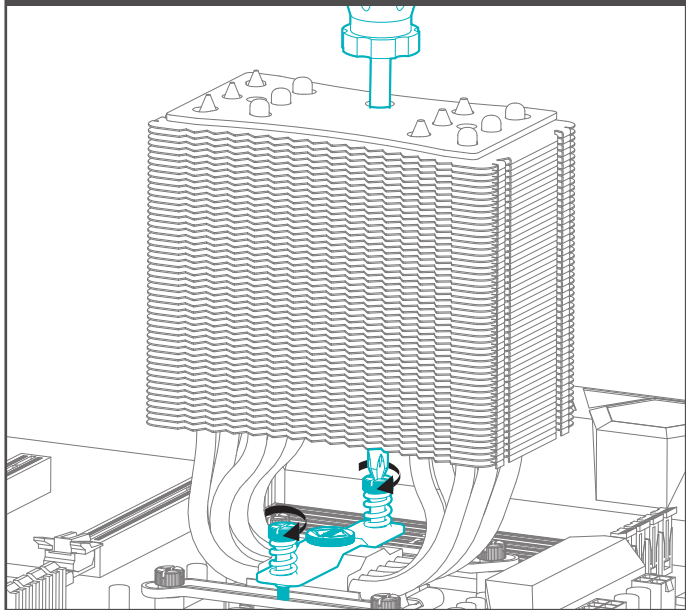

# Step 5

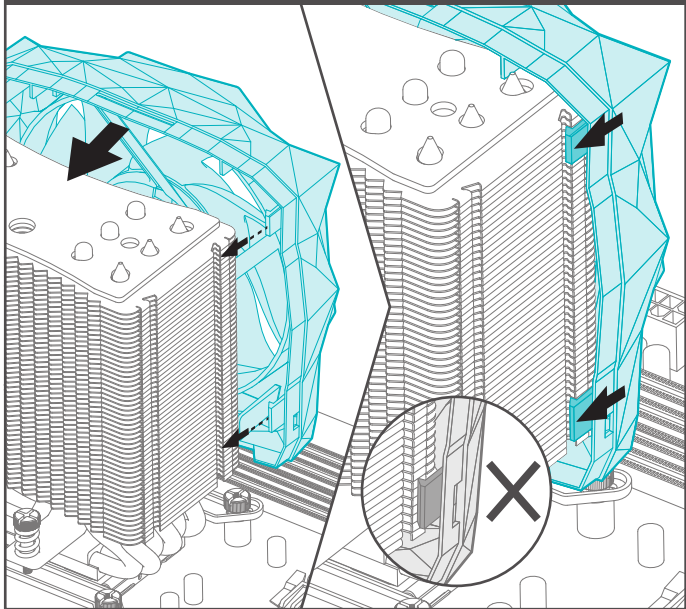

## Step 6

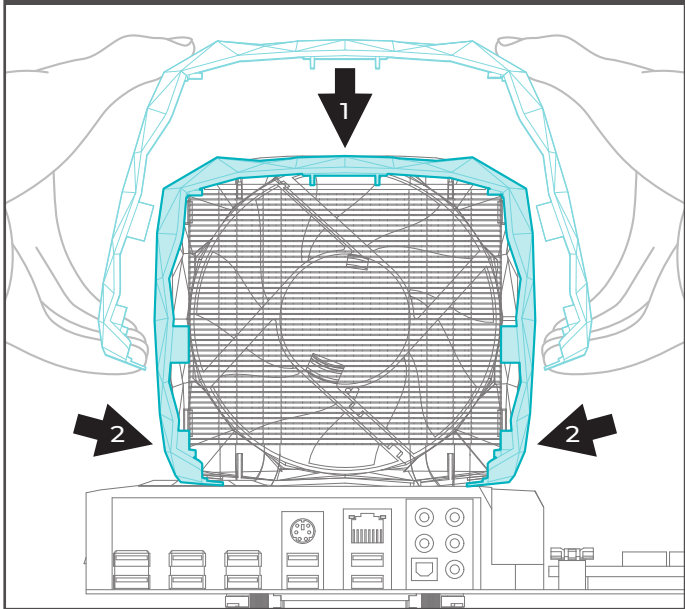



# Step 7

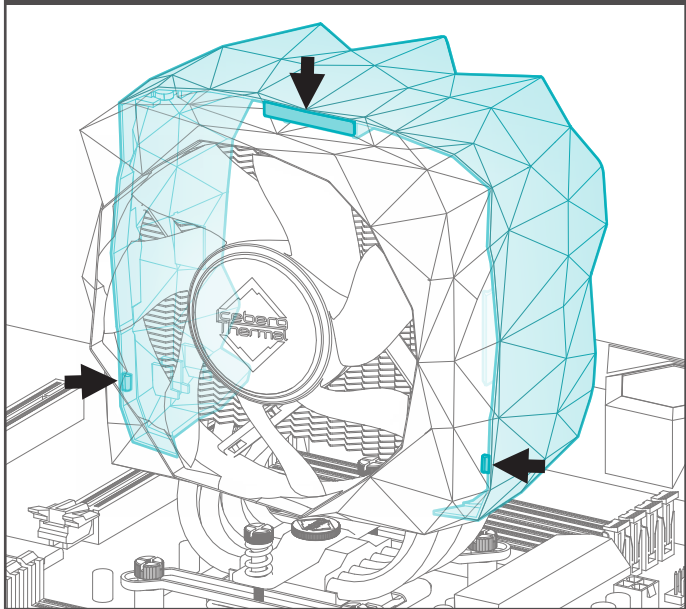

## Step 8

