

# OLYMPIA

## Accessories

Sensors for the Protect Series

## Operating Manual

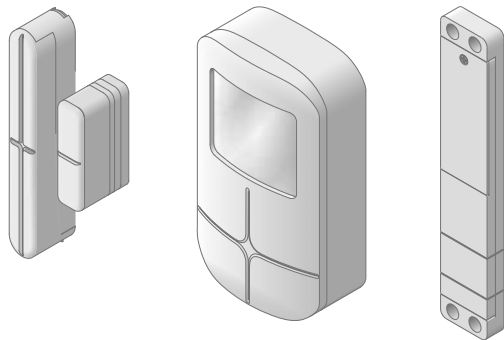



Hello,

We are delighted that you have decided to purchase these reliable devices from Olympia.

The descriptions on the following pages will explain how easy it is to make your home more safe and secure.



# Contents

<b>Before You Start</b> .....	<b>6</b>	<b>Mini Remote Control</b> .....	<b>19</b>
<b>Important Information on the Sensors</b> ..	<b>6</b>	Intended Use .....	19
<b>Safety Instructions</b> .....	<b>7</b>	Scope of Delivery .....	19
<b>Door/Window contact</b> .....	<b>9</b>	General View .....	19
Intended Use .....	9	Registering a Sensor .....	20
Scope of Delivery .....	9	Changing the Battery .....	20
General View .....	9	Monitoring Functions .....	21
Installation .....	10	SOS Key .....	21
Inserting the Batteries .....	10	Technical Data .....	21
Registering a Sensor .....	11	<b>Convenient Remote Control</b> .....	<b>22</b>
Technical Data .....	11	Intended Use .....	22
<b>Concealed Window Contact</b> .....	<b>12</b>	Scope of Delivery .....	22
Intended Use .....	12	General View .....	22
Scope of Delivery .....	12	Registering a Sensor .....	23
General View .....	12	Changing the Battery .....	23
Installation .....	13	Monitoring Functions .....	24
Inserting the Batteries .....	14	SOS Key .....	24
Registering a Sensor .....	14	Technical Data .....	24
Technical Data .....	14	<b>SOS/Panic Button</b> .....	<b>25</b>
<b>Motion Detector</b> .....	<b>15</b>	Intended Use .....	25
Intended Use .....	15	Scope of Delivery .....	25
Scope of Delivery .....	15	General View .....	25
General View .....	15	Registering a Sensor .....	26
Inserting the Batteries .....	16	Changing the Battery .....	26
Installation .....	16	Information on Use .....	26
Registering a Sensor .....	17	Technical Data .....	26
Technical Data .....	18		



<b>Vibration Sensor</b> .....	<b>27</b>	<b>Outdoor Siren</b> .....	<b>36</b>
Intended Use .....	27	Intended Use .....	36
Scope of Delivery .....	27	Scope of Delivery .....	36
General View .....	27	General View .....	36
Setting the Sensitivity .....	28	Inserting the Batteries .....	37
Installation .....	28	Installation .....	37
Registering a Sensor .....	28	Registering the Outdoor Siren .....	38
Changing the Battery .....	29	Technical Data .....	38
Technical Data .....	29	<b>TFS 200 Temperature Sensor</b> .....	<b>39</b>
<b>Water Detector</b> .....	<b>30</b>	Intended Use .....	39
Intended Use .....	30	Scope of Delivery .....	39
Scope of Delivery .....	30	General View .....	39
General View .....	30	Full Instruction Manual .....	39
Installation .....	31	Technical Data .....	39
Inserting the Batteries .....	31	<b>IR 500 Infrared light Barrier</b> .....	<b>40</b>
Registering a Sensor .....	31	Intended Use .....	40
Technical Data .....	32	Scope of Delivery .....	40
<b>Glass Breakage Detector</b> .....	<b>33</b>	General View .....	40
Intended Use .....	33	Technical Data .....	40
Scope of Delivery .....	33	<b>Appendix</b> .....	<b>41</b>
General View .....	33	Troubleshooting .....	41
Installation .....	34	Information on Disposal .....	42
Inserting the Batteries .....	34	Guarantee .....	42
Registering a Sensor .....	35	Cleaning and Service .....	43
Technical Data .....	35	Information on Conformity .....	43



## Before You Start

The sensors used in the alarm systems in the Protect series are passive security products and have been developed for use as deterrents. Additional measures are necessary to prevent and hinder burglary and theft. You can obtain all the necessary information on this from your local police station.



Read the operating manual thoroughly and observe all the information contained when using the alarm system. Keep the operating manual in a safe place for future reference.



Pay attention to this symbol. Texts which are highlighted by this symbol provide helpful information on handling the alarm system.

## Important Information on the Sensors

- The sensors are intended for private use indoors (exception: outdoor siren).
- The sensors only work in combination with an alarm system from the Protect series!
- All the individual sensors must be installed within transmission range of the base unit of the Protect series alarm system.
- More detailed information on how to configure the alarm system (e.g. changing the name of a sensor) is available in the operating manual supplied with the base unit.



## Safety Instructions

The following safety information applies to the entire document.

Read and observe all the safety information to protect yourself and the environment from any harm.

The following warnings indicate potentially dangerous situations which could lead to serious injuries or even fatal injuries if the information is ignored.



**WARNING!** Risk of fatal injury from electric shock! **NEVER** use the device if you suspect damage to the power cable or power plug or there are visible signs of damage to the power cable or power plug.



**NEVER** complete any repairs to the device yourself. Never open the device because it contains no components which you may service yourself. In the event of a fault, contact our Service Department.



**WARNING!** Risk of suffocation! Children can swallow small parts, packaging and protective foils. Keep the device and packaging out of reach of children.



**WARNING!** Risks to health through batteries! Keep batteries out of reach of children. Do not swallow batteries. If any type of battery or round cell is swallowed, seek medical attention immediately.



**WARNING!** Risk of explosion! Improper storage of batteries can put your health and the environment at risk. Batteries may contain toxic, ecologically hazardous heavy metals. Never open, damage or swallow batteries or allow them to pollute the environment.



**WARNING!** Risk of serious injuries through damaging cables or pipes! During installation, pay attention to the possibility of cables and pipes running in the walls. We are not deemed liable for installation errors. If in doubt, contact a specialist!



The following warnings indicate potentially dangerous situations which could lead to minor or slight injuries if the information is ignored.



**CAUTION!** This device can be used by children from the age of 8 and persons with restricted physical, sensory or mental capabilities or a lack of experience and knowledge as long as they are supervised or have been instructed with regard to safe use of the device and are aware of the potential risks involved with its use. Children must never play with the device. Cleaning and user maintenance may not be completed by children without any supervision.



**CAUTION!** Hearing damage through loud alarm signal! Due to legal requirements, the alarm signal continues for maximally 120 seconds. Use ear protectors when testing the device. Do not remain in the vicinity of the acoustic alarm for a longer period when it has been triggered.

The following warnings indicate potentially dangerous situations which could lead to property damage if the information is ignored.

**IMPORTANT!** Risk of property damage through the use of inappropriate batteries! The use of inappropriate batteries can cause a loss of function of the device. Only use the batteries supplied or those of the type described in Section "Technical Data".

**IMPORTANT!** Risk of property damage through environmental influences! Prevent environmental influences such as exposure to smoke, dust, vibration, chemicals, moisture, heat and direct sunlight.

**IMPORTANT!** Before starting to install, fix or position the sensors, take into account that walls, ceilings and sources of electrical disturbance can impair wireless communication.





## Door/Window contact

### Intended Use

The door/window contact consists of the transmitter unit and the magnet unit and serves for monitoring the condition of doors and windows (open/closed).

A condition for complying with the intended use is that the equipment is installed correctly and the information in the manual is observed and maintained. Any other use is considered unintended use.

### Scope of Delivery

Please check the contents of the package carefully. If anything is missing or has been damaged during transport, DO NOT put the door/window contact into operation!

Door/Window contact	1
Batteries	2 x AAA battery
Assembly material	Screws, adhesive tape
Operating manual	1

### General View

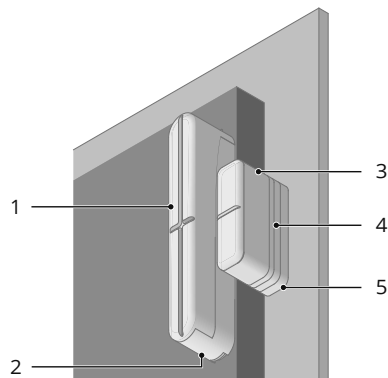

1	Transmitter (with battery compartment)
2	Mounting bracket
3	Magnet unit
4	Spacers (optional)
5	Mounting bracket



### Installation

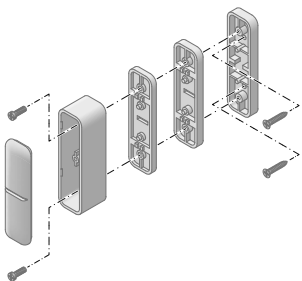

 Pay attention that the surfaces to be adhered to are free of dust and grease.

1 Fix the mounting bracket for the transmitter and mounting bracket for the magnet unit in place using double-sided adhesive tape.

 Fix the door/window contact in place, positioned and aligned as illustrated above. Otherwise, there is no guarantee that the door/window contact will function properly.

2 Mount the battery compartment on the mounting bracket of the transmitter.

3 Mount the magnet unit on the mounting bracket of the magnet unit.

 The transmitter and magnet unit must be on the same plane. Optionally, you can use the spacers which can be fitted on the mounting bracket of the magnet unit. Use the appropriate screws supplied.

 The distance between the transmitter and magnet unit when assembled may be maximally 5 mm.

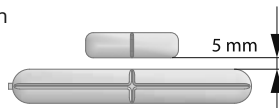

### Inserting the Batteries

- 1 Open the transmitter by pressing the lock downwards.
- 2 Insert the batteries in the battery compartment. Pay attention that the batteries are inserted the right way around.
- 3 Fit the battery compartment on the mounting bracket. The lock engages audibly.

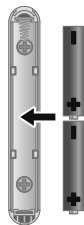



## Registering a Sensor

- 1 Select the **Register** menu option on the base unit.
- 2 Trigger the sensor by opening the window or door being monitored.
- 3 The base unit display indicates that registration has been completed successfully on the alarm system.



If registering was not successful. Refer to Section **Troubleshooting**.

## Technical Data

<b>Weight</b>	Approx. 38 g
<b>Dimensions (W x H x D)</b>	Transmitter 15.7 x 106.8 x 22 mm Magnet unit 11.5 x 48 x 34.5 mm
<b>Radio frequency</b>	868.5 MHz
<b>Transmission power (max.)</b>	0.7 mW
<b>Batteries</b>	2 x AAA batteries
<b>Permissible ambient conditions</b>	-10 °C to +40 °C at 30% to 75% rel. humidity



## Concealed Window Contact

### Intended Use

The window contact consists of the transmitter unit and the magnet unit and serves for monitoring the condition of windows (open/closed). As a result of its compact dimensions, it is perfectly suited for a concealed assembly between the window frame and window casement.

A condition for complying with the intended use is that the equipment is installed correctly and the information in the manual is observed and maintained. Any other use is considered unintended use.

### Scope of Delivery

Please check the contents of the package carefully. If anything is missing or has been damaged during transport, DO NOT put the door/window contact into operation!

Window contact	1
Battery	2 x round cell batteries, CR2354, 3 V
Assembly material	Screws, adhesive tape
Operating manual	1

### General View

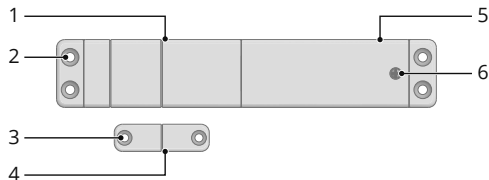

- 1 Transmitter
- 2 Hole for screw
- 3 Hole for screw
- 4 Magnet unit
- 5 Battery compartment cover
- 6 Screw for battery compartment cover



## Installation

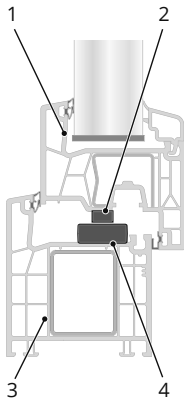

- 1 Window casement

---

- 2 Magnet unit

---

- 3 Window frame

---

- 4 Transmitter

 Pay attention that the surfaces to be adhered to are free of dust and grease.

- 1 Fix the transmitter to the window frame as illustrated using double-sided adhesive tape.

Any misalignment within the window frame can be compensated for using the spacers supplied. Fix the spacers to the underside of the transmitter using the screws supplied.

- 2 Fix the magnet unit on the window casement so that the magnet unit is positioned directly over the transmitter, as illustrated, when the window is closed.

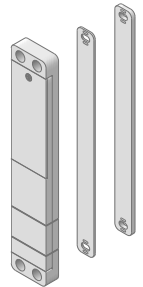

 Where necessary, you can also fix the transmitter and magnet unit to the window frame and window casement, respectively, using the screws supplied.



## Registering a Sensor

The window contact is supplied with batteries already inserted.

- 1 Select the **Register** menu option on the base unit.
- 2 Remove the plastic strip.
- 3 The base unit display indicates that registration has been completed successfully on the alarm system.



If registering was not successful. Refer to Section **Troubleshooting**.

## Changing the Batteries

- 1 Loosen the screw in the battery compartment cover using an appropriate screwdriver.
- 2 Remove the battery compartment cover.
- 3 Remove the batteries.
- 4 Insert new batteries of the same type in the battery compartment. Pay attention that the batteries are inserted the right way around.
- 5 Replace the battery compartment cover.
- 6 Tighten the screw in the battery compartment cover using an appropriate screwdriver.

## Technical Data

<b>Weight</b>	Approx. 38 g
<b>Dimensions (W x H x D)</b>	Window contact 25 x 140 x 9.5 mm Magnet unit 11.5 x 34.5 x 9.5 mm
<b>Radio frequency</b>	868.5 MHz
<b>Transmission power (max.)</b>	6.1 mW
<b>Batteries</b>	2 x round cell batteries, CR2354 3 V
<b>Permissible ambient conditions</b>	-10 °C to +40 °C at 30% to 75% rel. humidity

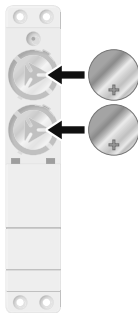



## Motion Detector

### Intended Use

The wireless motion detector reacts to movements within the detection range of the sensor.

A condition for complying with the intended use is that the equipment is installed correctly and the information in the manual is observed and maintained. Any other use is considered unintended use.

### Scope of Delivery

Please check the contents of the package carefully. If anything is missing or has been damaged during transport, DO NOT put the motion detector into operation!

Motion detector	1
Mounting bracket	1
Batteries	3 x round cell batteries, type AA
Assembly material	Screws, dowels
Operating manual	1

### General View

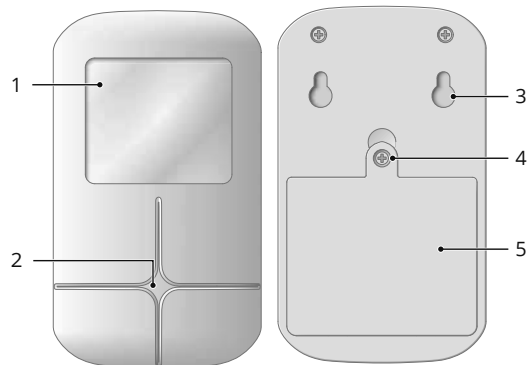

1	Motion sensor
2	LED
3	Recesses for mounting bracket
4	Screw for battery compartment cover
5	Battery compartment cover



### Inserting the Batteries

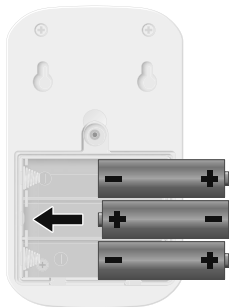

- 1 Loosen the screw in the battery compartment cover using an appropriate screwdriver.
- 2 Remove the battery compartment cover.
- 3 Insert the batteries in the battery compartment. Pay attention that the batteries are inserted the right way around.
- 4 Replace the battery compartment cover.
- 5 Tighten the screw in the battery compartment cover using an appropriate screwdriver.

### Installation

#### Appropriate Installation Locations

Position the motion detector so that an intruder must move through part of the area being monitored.

An optimal installation location is directly in a corner, two meters from the floor at an angle of 14 degrees. The possible direction of movement of an intruder should be frontal towards the motion detector.

#### Inappropriate Installation Locations

The area to be monitored by the motion detector must not be obstructed by objects.

Avoid locations prone to quick temperature changes in the area monitored, near an air-con unit or heater, for example.

No pets should have access to the area to be monitored by the motion detector when the alarm system is armed.



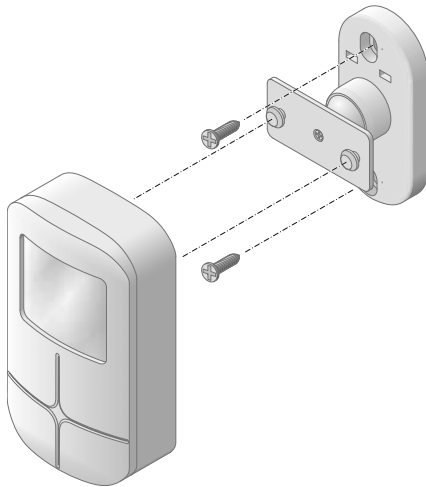

The wireless motion detector is provided with a wall bracket which can be mounted on a wall as well as on a ceiling.

**WARNING!**  
Risk of serious injuries through damaging cables or pipes! During installation, pay attention to the possibility of cables and pipes running in the walls. We are not deemed liable for installation errors. If in doubt, contact a specialist!

- 1 Drill two holes, about 45 mm apart, at the intended installation location.
- 2 Assemble the wall mounting bracket using screws supplied.
- 3 Hook the recesses on the rear side of the motion detector on the mounting bracket.

### Registering a Sensor

- 1 Select the **Register** menu option on the base unit.
- 2 Move inside the area monitored by the motion detector.
- 3 The base unit display indicates that registration has been completed successfully on the alarm system.



If registering was not successful. Refer to Section **Troubleshooting**.



## Technical Data

Weight	Approx. 88 g
Dimensions (W x H x D)	70 x 127 x 40 mm
Radio frequency	868.5 MHz
Transmission power (max.)	1.6 mW
Monitoring radius	120°
Monitoring range	8 m
Battery	3 x round cell batteries, type AA
Permissible ambient conditions	-10 °C to +40 °C at 30% to 75% rel. humidity



## Mini Remote Control

### Intended Use

The mini remote control serves for the remote control of an alarm system from the Protect series.

A condition for complying with the intended use is that the equipment is installed correctly and the information in the manual is observed and maintained. Any other use is considered unintended use.

### Scope of Delivery

Please check the contents of the package carefully. If anything is missing or has been damaged during transport, DO NOT put the mini remote control into operation!

Mini remote control	1
Battery	Round cell battery, CR2032, 3 V
Operating manual	1

### General View

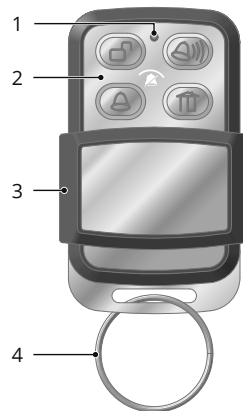

- |   |               |
|---|---------------|
| 1 | LED           |
| 2 | Function keys |
| 3 | Cover         |
| 4 | Key ring      |



## Registering a Sensor

The remote control is supplied with a battery already inserted.

- 1 Select the **Register** menu option on the base unit.
- 2 Remove the plastic strip.
- 3 The base unit display indicates that registration has been completed successfully on the alarm system.

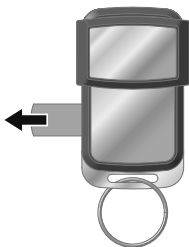

 If registering was not successful. Refer to Section **Troubleshooting**.

## Changing the Battery



- 1 Loosen the screws in the battery compartment cover using an appropriate screwdriver.
- 2 Remove the battery compartment cover.
- 3 Remove the battery contained.
- 4 Insert a new battery of the same type in the battery compartment. Pay attention that the battery is inserted the right way around.
- 5 Replace the battery compartment cover on the battery compartment.
- 6 Tighten the screws in the battery compartment cover using an appropriate screwdriver.



## Monitoring Functions

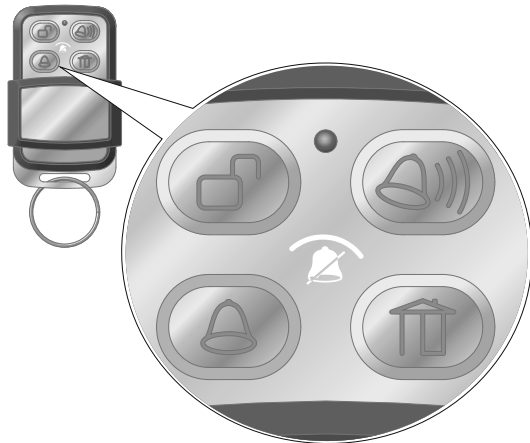

 Disarmed mode

 Alarm mode

 At Home mode

 SOS/Emergency call key

 Silent mode

## SOS Key

The  key on the mini remote control can be configured as an Emergency Call or Panic key via the base unit of the alarm system.

 More detailed information is available in the operating manual supplied with the base unit.

## Technical Data

Weight	Approx. 24 g
Dimensions (W x H x D)	34 x 55 x 13 mm
Radio frequency	868.5 MHz
Transmission power (max.)	1.6 mW
Battery	Round cell battery, CR2032, 3 V
Permissible ambient conditions	-10 °C to +40 °C at 30% to 75% rel. humidity



## Convenient Remote Control

### Intended Use

The convenient remote control serves for the remote control of an alarm system from the Protect series.

A condition for complying with the intended use is that the equipment is installed correctly and the information in the manual is observed and maintained. Any other use is considered unintended use.

### Scope of Delivery

Please check the contents of the package carefully. If anything is missing or has been damaged during transport, DO NOT put the convenient remote control into operation!

Convenient remote control	1
Battery	Round cell battery, CR2032, 3 V
Operating manual	1

### General View

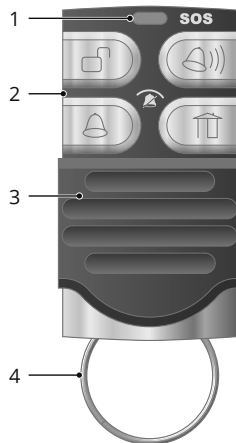

- |   |               |
|---|---------------|
| 1 | LED           |
| 2 | Function keys |
| 3 | Cover         |
| 4 | Key ring      |



## Registering a Sensor

The convenient remote control is supplied with a battery already inserted.

- 1 Select the **Register** menu option on the base unit.
- 2 Remove the plastic strip.
- 3 The base unit display indicates that registration has been completed successfully on the alarm system.

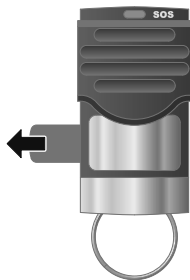

 If registering was not successful. Refer to Section **Troubleshooting**.

## Changing the Battery

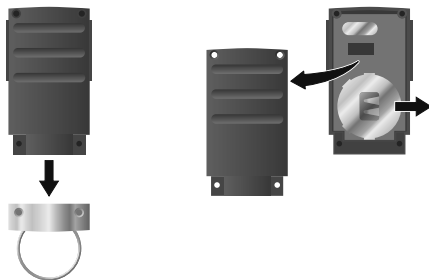

- 1 Loosen the screws in the battery compartment cover using an appropriate screwdriver.
- 2 Remove the battery compartment cover.
- 3 Remove the battery contained.
- 4 Insert a new battery of the same type in the battery compartment.
- 5 Replace the battery compartment cover on the battery compartment.
- 6 Tighten the screws in the battery compartment cover using an appropriate screwdriver.



## Monitoring Functions

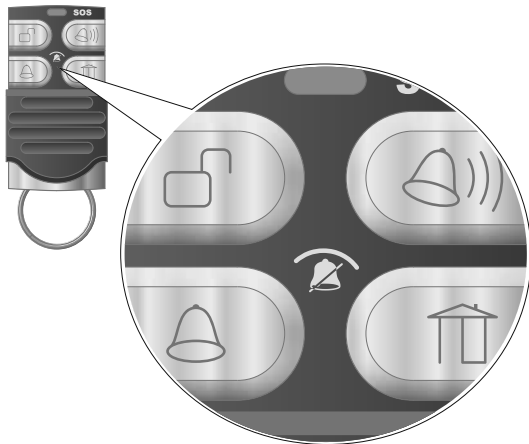

 Disarmed mode

 Alarm mode

 At Home mode

 SOS/Emergency call key

 Silent mode

## SOS Key

The  key on the convenient remote control can be configured as an Emergency Call or Panic key via the base unit of the alarm system.

 More detailed information is available in the operating manual supplied with the base unit.

## Technical Data

Weight	Approx. 16 g
Dimensions (W x H x D)	30 x 58.5 x 13.7 mm
Radio frequency	868.5 MHz
Transmission power (max.)	0.04 mW
Battery	Round cell battery, CR2032, 3 V
Permissible ambient conditions	-10 °C to +40 °C at 30% to 75% rel. humidity





## SOS/Panic Button

### Intended Use

The SOS/Panic button issues a remote command to an alarm system from the Protect series.

A condition for complying with the intended use is that the equipment is installed correctly and the information in the manual is observed and maintained. Any other use is considered unintended use.

### Scope of Delivery

Please check the contents of the package carefully. If anything is missing or has been damaged during transport, DO NOT put the SOS/Panic button into operation!

SOS/Panic button	1
Battery	Round cell battery, CR2430, 3 V
Operating manual	1

### General View

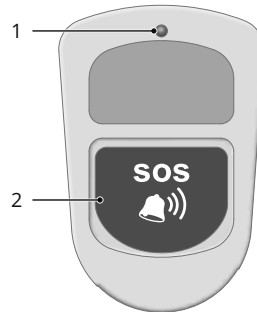

- |   |                  |
|---|------------------|
| 1 | LED              |
| 2 | SOS/Panic button |



## Registering a Sensor

The SOS/Panic button is supplied with a batteries already installed.

- 1 Select the **Register** menu option on the base unit.
- 2 Remove the plastic strips.
- 3 The base unit display indicates that registration has been completed successfully on the alarm system.

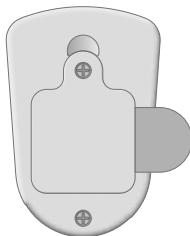

 If registering was not successful. Refer to Section **Troubleshooting**.

## Changing the Battery

- 1 Loosen the screw in the battery compartment cover using an appropriate screwdriver.
- 2 Remove the battery compartment cover.
- 3 Remove the battery contained.
- 4 Insert a new battery of the same type in the battery compartment. Pay attention that the battery is inserted the right way around.

- 5 Replace the battery compartment cover on the battery compartment.
- 6 Tighten the screw in the battery compartment cover using an appropriate screwdriver.

## Information on Use

The SOS/Panic button can be carried in a pocket or hung around the neck so it is permanently close by.

By simply pressing the button on the SOS/Panic button unit once, you can send an emergency call or trigger an alert signal on the base unit of the alarm system.

## Technical Data

Weight	Approx. 28 g
Dimensions (W x H x D)	40 x 59 x 15 mm
Radio frequency	868.5 MHz
Transmission power (max.)	0.05 mW
Battery	Round cell battery, CR2430, 3 V
Permissible ambient conditions	-10 °C to +40 °C at 30% to 75% rel. humidity



## Vibration Sensor

### Intended Use

The vibration sensor is designed to detect vibrations and send a signal to the base unit of the alarm system.

A condition for complying with the intended use is that the equipment is installed correctly and the information in the manual is observed and maintained. Any other use is considered unintended use.

### Scope of Delivery

Please check the contents of the package carefully. If anything is missing or has been damaged during transport, DO NOT put the vibration sensor into operation!

Vibration sensor	1
Battery	Round cell battery, CR2032, 3 V
Operating manual	1

### General View

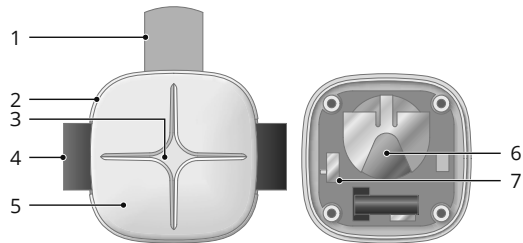

1	Plastic strips
2	Holder
3	LED
4	Felt strip (with hook-and-loop fastener)
5	Vibration Sensor
6	Battery
7	DIP switch (sensitivity setting)



## Setting the Sensitivity

- 1 Loosen the screws in the battery compartment cover using an appropriate screwdriver.
- 2 Remove the battery compartment cover.
- 3 Set the sensitivity of the vibration sensor using the DIP switch (H = High, L = Low).
- 4 Replace the battery compartment cover on the battery compartment.
- 5 Tighten the screws in the battery compartment cover using an appropriate screwdriver.

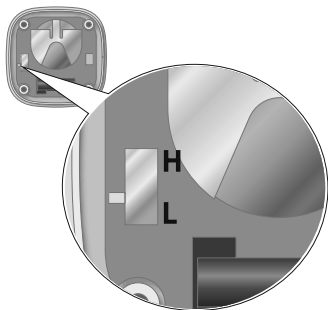

## Installation

Position the vibration sensor in an appropriate location. When the vibration sensor detects any vibration (agitation), the LED lights up and the vibration sensor sends a signal to the base unit of the alarm system.

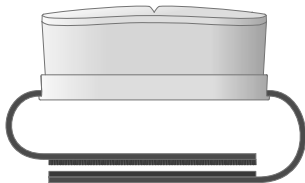

Use the practical holder to fix the vibration sensor firmly at any suitable location with the aid of the hook-and-loop fastener.

## Registering a Sensor

- 1 Select the **Register** menu option on the base unit.
- 2 Remove the plastic strips.
- 3 Trigger the vibration sensor by shaking the vibration sensor.
- 4 The base unit display indicates that registration has been completed successfully on the alarm system.



If registering was not successful. Refer to Section **Troubleshooting**.



## Changing the Battery

- 1 Loosen the screws in the battery compartment cover using an appropriate screwdriver.
- 2 Remove the battery compartment cover.
- 3 Remove the battery contained.
- 4 Insert a new battery of the same type in the battery compartment. Pay attention that the batteries are inserted the right way around.
- 5 Replace the battery compartment cover on the battery compartment.
- 6 Tighten the screws in the battery compartment cover using an appropriate screwdriver.

## Technical Data

<b>Weight</b>	Approx. 86 g
<b>Dimensions (W x H x D)</b>	Vibration sensor 41 x 17 x 41 mm Felt strip (length) 280 mm
<b>Radio frequency</b>	868.5 MHz
<b>Transmission power (max.)</b>	0.8 mW
<b>Battery</b>	Round cell battery, CR2032, 3 V
<b>Permissible ambient conditions</b>	-10 °C to +40 °C at 30% to 75% rel. humidity



## Water Detector

### Intended Use

The water detector serves for the early detection of high water levels indicating potential flooding.

A condition for complying with the intended use is that the equipment is installed correctly and the information in the manual is observed and maintained. Any other use is considered unintended use.

### Scope of Delivery

Please check the contents of the package carefully. If anything is missing or has been damaged during transport, DO NOT put the water leak detector into operation!

Water detector	1
Batteries	2 x AAA battery
Assembly material	Adhesive tape
Operating manual	1

### General View

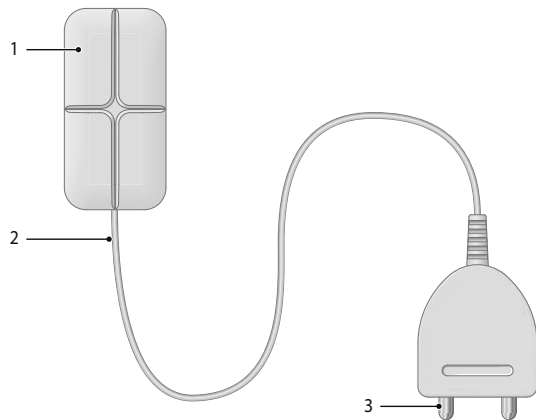

- 1 Battery compartment
- 2 Sensor cable
- 3 Sensor with contact surfaces



## Installation

-  Pay attention that the surfaces to be adhered to are free of dust and grease.

The water detector is suitable for installation locations where there is a risk of flooding, e.g. through water-supplying equipment, intruding rain water or overflowing tanks .

- 1 Position the sensors at the site to be monitored.

Observe:

- The distance between the maximum fill quantity and contact surfaces of the sensors must be approx 1 mm.
- The battery compartment is not waterproof. Use the double-sided adhesive tape included in the package contents to mount the battery compartment in a protected location.

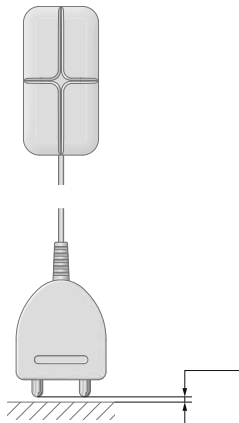

## Inserting the Batteries

- 1 Open the battery compartment by pressing the locking latch down using an appropriate, pointed object.
- 2 Insert two batteries in the battery compartment. Pay attention that the batteries are inserted the right way around.
- 3 Close the battery compartment. The lock engages audibly.



## Registering a Sensor

- 1 Select the **Register** menu option on the base unit.
- 2 Trigger the sensors by immersing the contact surfaces in water.
- 3 The base unit display indicates that registration has been completed successfully on the alarm system.

-  If registering was not successful. Refer to Section **Troubleshooting**.



## Technical Data

Weight	Approx. 86 g
Dimensions (W x H x D)	15 x 105 x 22 mm
Radio frequency	868.5 MHz
Transmission power (max.)	0.8 mW
Battery	2 x AAA battery
Permissible ambient conditions	-10 °C to +40 °C at 30% to 75% rel. humidity





## Glass Breakage Detector

### Intended Use

The glass breakage detector reacts to vibration, which is a typical result of an attempted burglary (smashing, drilling, sawing, levering).

A condition for complying with the intended use is that the equipment is installed correctly and the information in the manual is observed and maintained. Any other use is considered unintended use.

### Scope of Delivery

Please check the contents of the package carefully. If anything is missing or has been damaged during transport, DO NOT put the glass breakage detector into operation!

Glass breakage detector	1
Batteries	2 x AAA battery
Assembly material	Adhesive tape
Operating manual	1

### General View

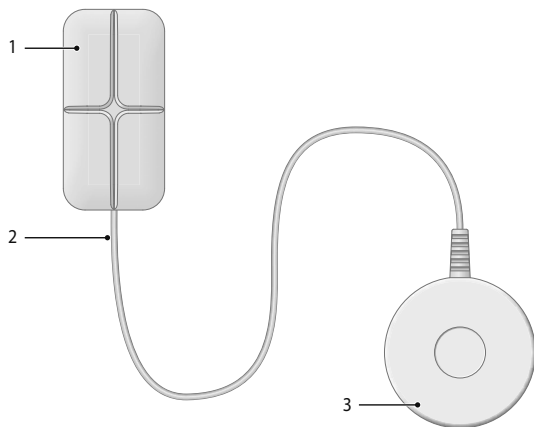

- |   |                              |
|---|------------------------------|
| 1 | Battery compartment          |
| 2 | Sensor cable                 |
| 3 | Sensor with contact surfaces |



### Installation

#### Appropriate Installation Locations

- On objects which are valuable or contain valuable items, e.g. pictures, safes, drawers etc.
- On objects which can be easily broken or forced open, e.g. glass panes, plasterboard walls, wooden doors, etc.

#### Inappropriate Installation Locations

- Near the floor.
- In the vicinity of metallic structures, electrical cables or gas pipelines, electrical or radio equipment.
- On objects which move of their own accord.

 Pay attention that the surfaces to be adhered to are free of dust and grease.

- 1 Position the sensor with the contact surfaces at the site to be monitored. Use the double-sided adhesive tape supplied.

### Inserting the Batteries

- 1 Open the battery compartment by pressing the locking latch down using an appropriate, pointed object.
- 2 Insert two batteries in the battery compartment. Pay attention that the batteries are inserted the right way around.
- 3 Close the battery compartment. The lock engages audibly.





## Registering a Sensor

- 1 Select the **Register** menu option on the base unit.
- 2 Remove a battery from the glass breakage detector and then replace it in the glass breakage detector.
- 3 The base unit display indicates that registration has been completed successfully on the alarm system.



If registering was not successful. Refer to Section **Troubleshooting**.

## Technical Data

Weight	Approx. 86 g
Dimensions (W x H x D)	15 x 105 x 22 mm
Radio frequency	868.5 MHz
Transmission power (max.)	0.8 mW
Battery	2 x AAA battery
Permissible ambient conditions	-10 °C to +40 °C at 30% to 75% rel. humidity



## Outdoor Siren

### Intended Use

The outdoor siren issues a loud acoustic signal in addition to a visual alert in the event an alarm is triggered.

A condition for complying with the intended use is that the equipment is installed correctly and the information in the manual is observed and maintained. Any other use is considered unintended use.

### Scope of Delivery

Please check the contents of the package carefully. If anything is missing or has been damaged during transport, DO NOT put the outdoor siren into operation!

Outdoor siren	1
Battery	3 x round cell batteries, type AA
Assembly material	Screws, dowels
Operating manual	1

### General View



1	LED (lights up for an alarm)
2	Loudspeaker
3	Power adapter port (option)
4	Recesses for mounting bracket
5	Screw for battery compartment
6	Battery compartment



## Inserting the Batteries

- 1 Loosen the screws in the battery compartment cover using an appropriate screwdriver.
- 2 Insert the batteries in the battery compartment. Pay attention that the batteries are inserted the right way around.
- 3 Replace the battery compartment cover on the outdoor siren.
- 4 Tighten the screw in the battery compartment cover using an appropriate screwdriver.

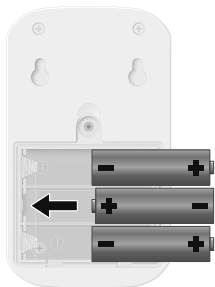

## Installation



**WARNING!** Risk of serious injuries through damaging cables or pipes! During installation, pay attention to the possibility of cables and pipes running in the walls. We are not deemed liable for installation errors. If in doubt, contact a specialist!

- 1 Drill two holes, about 37 mm apart, at the intended installation location.
- 2 Insert the screws supplied with the aid of dowels.
- 3 Hook the slots in the rear panel of the outdoor siren on the screws installed in the wall in Step 2.



## Registering the Outdoor Siren

- 1 Select the **Register** menu option on the base unit.
- 2 Remove the batteries from the outdoor siren's battery compartment.
- 3 Replace the battery in the battery compartment.
- 4 The base unit display indicates that registration has been completed successfully on the alarm system.



If registering was not successful. Refer to Section **Troubleshooting**.



Alternatively, the outdoor siren can be operated by means of a power adapter. The power adapter is not included in the equipment supplied. Either contact our Service Department or visit our website at [www.olympia-vertrieb.de](http://www.olympia-vertrieb.de)

## Technical Data

<b>Weight</b>	Approx. 198 g
<b>Dimensions (W x H x D)</b>	92 x 138 x 49 mm
<b>Radio frequency</b>	868.5 MHz
<b>Transmission power (max.)</b>	0.4 mW
<b>Battery</b>	3 x round cell batteries, type AA
<b>Permissible ambient conditions</b>	-10 °C to +40 °C at 30% to 75% rel. humidity



## TFS 200 Temperature Sensor

### Intended Use

The temperature sensor serves to display and monitor the temperature.

A condition for complying with the intended use is that the equipment is installed correctly and the information in the manual is observed and maintained. Any other use is considered unintended use.

### Scope of Delivery

Please check the contents of the package carefully. If anything is missing or has been damaged during transport, DO NOT put the temperature sensor into operation!

Temperature sensor	1
Batteries	1 x AAA battery
Operating manual	1

### General View

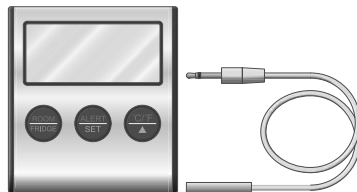

### Full Instruction Manual

Read the full instruction manual for information on how the temperature sensor is started up, operated, registered on the base unit of the alarm system or how to change the batteries.

### Technical Data

Weight	Approx. 86 g
Dimensions (W x H x D)	65 x 71.5 x 21 mm
Radio frequency	868.5 MHz
Transmission power (max.)	0.6 mW
Battery	1 x AAA battery
Permissible ambient conditions	-10 °C to +40 °C at 30% to 75% rel. humidity



## IR 500 Infrared light Barrier

### Intended Use

The infrared light barrier consists of a transmitter and a receiver. If the connection between the transmitter and receiver is interrupted by an object, the interruption is indicated by an acoustic alarm or doorbell chime.

A condition for complying with the intended use is that the equipment is installed correctly and the information in the manual is observed and maintained. Any other use is considered unintended use.

### Scope of Delivery

Please check the contents of the package carefully. If anything is missing or has been damaged during transport, DO NOT put the infrared light barrier into operation!

Infrared light barrier	1
Batteries	6 x round cell batteries, type AA
Power adapter	2
Assembly material	Screws, dowels
Operating manual	1

### General View



### Full Instruction Manual

Read the full instruction manual for information on how the infrared light barrier is started up, operated, registered on the base unit of the alarm system or how to change the batteries.

### Technical Data

Weight	Approx. 198 g
Dimensions (W x H x D)	80 x 120 x 40 mm
Radio frequency	868.5 MHz
Transmission power (max.)	8 mW
Battery	3 x round cell batteries, type AA
Permissible ambient conditions	-10 °C to +40 °C at 30% to 75% rel. humidity





## Appendix

### Troubleshooting

**I cannot register the sensors on the base unit of the alarm system.**

The maximum number of sensors which can be registered on the base unit has been reached - deregister sensors from the base unit before attempting to register another sensor on the base unit.

Ensure that the Register option has been selected on the base unit before attempting to register a sensor.

More detailed information is available in the operating manual supplied with the base unit.

**The sensor does not respond or does not work.**

The batteries are weak or empty. Replace the empty batteries with new ones and try again.

**The sensor reacts too sensitively or triggers too quickly.**

If possible, adjust the sensitivity of the of the sensor (e.g. vibration sensor).

Check whether the sensor is mounted or positioned at a suitable location. Observe the corresponding sections in this operating manual.

**If the proposed solutions prove unsuccessful.**

Visit our website: [www.olympia-vertrieb.de](http://www.olympia-vertrieb.de).

If you cannot find the information you need there either, please contact our Service Hotline.



## Information on Disposal



The adjacent symbol indicates that electrical and electronic apparatus and batteries no longer required must be disposed of separate from domestic waste in accordance with legal directives.

You are legally obliged to dispose of batteries and power packs at shops which sell batteries or collection points which provide the corresponding containers. Disposal is free of charge. The symbols indicate that the batteries must not be disposed of in normal domestic waste and that they must be brought to collection points provided by local public waste authorities.



Packaging materials must be disposed of according to local regulations.

## Guarantee

Dear Customer,

we are pleased that you have chosen this equipment.

In the case of a defect, please return the device together with the receipt and original packing material to the point-of-sale.



## Cleaning and Service

- 1 Disconnect the sensors from the power outlet before cleaning, if necessary!
- 2 Clean the surface of the housing with a soft, lint-free cloth. Never use any chemicals or scouring agents.
- 3 Check the functionality of each sensor registered once a month and after changing the batteries.
- 4 Change the batteries at least once a year or after receiving the relevant message from the alarm system.

## Information on Conformity

**CE** Olympia Business Systems Vertriebs GmbH, Zum Kraftwerk 1, 45527 Hattingen hereby declares that these devices fulfil the basic requirements and other relevant provisions stipulated in the Directive 2014/53/EU. The CE Mark on the devices confirms conformity.

More detailed information on the Declaration of Conformity is contained on the supplementary sheet issued with the respective sensor.

# OLYMPIA

v1.0, 06.2017

Door/Window Contact	6102
Concealed Window Contact	6104
Motion Detector	6108
Mini Remote Control	6101
Convenient Remote Control	6100
SOS/Panic Button	5912
Vibration Sensor	6107
Water Detector	6105
Glass Breakage Detector	6106
Outdoor Siren	6109
Temperature Sensor, TFS 200	5963
Infrared Light Barrier, IR 500	5964