

# ZYXEL

Your Networking Ally

# User's Guide

## GS1200 Series

GS1200-5/GS1200-5HP v2/GS1200-8/GS1200-8HP v2

5-Port / 8-Port Web Managed (PoE) Gigabit Switch

### Default Login Details

LAN IP Address	http://192.168.1.3
Password	1234

Version 1.00 Edition 1, 12/2017

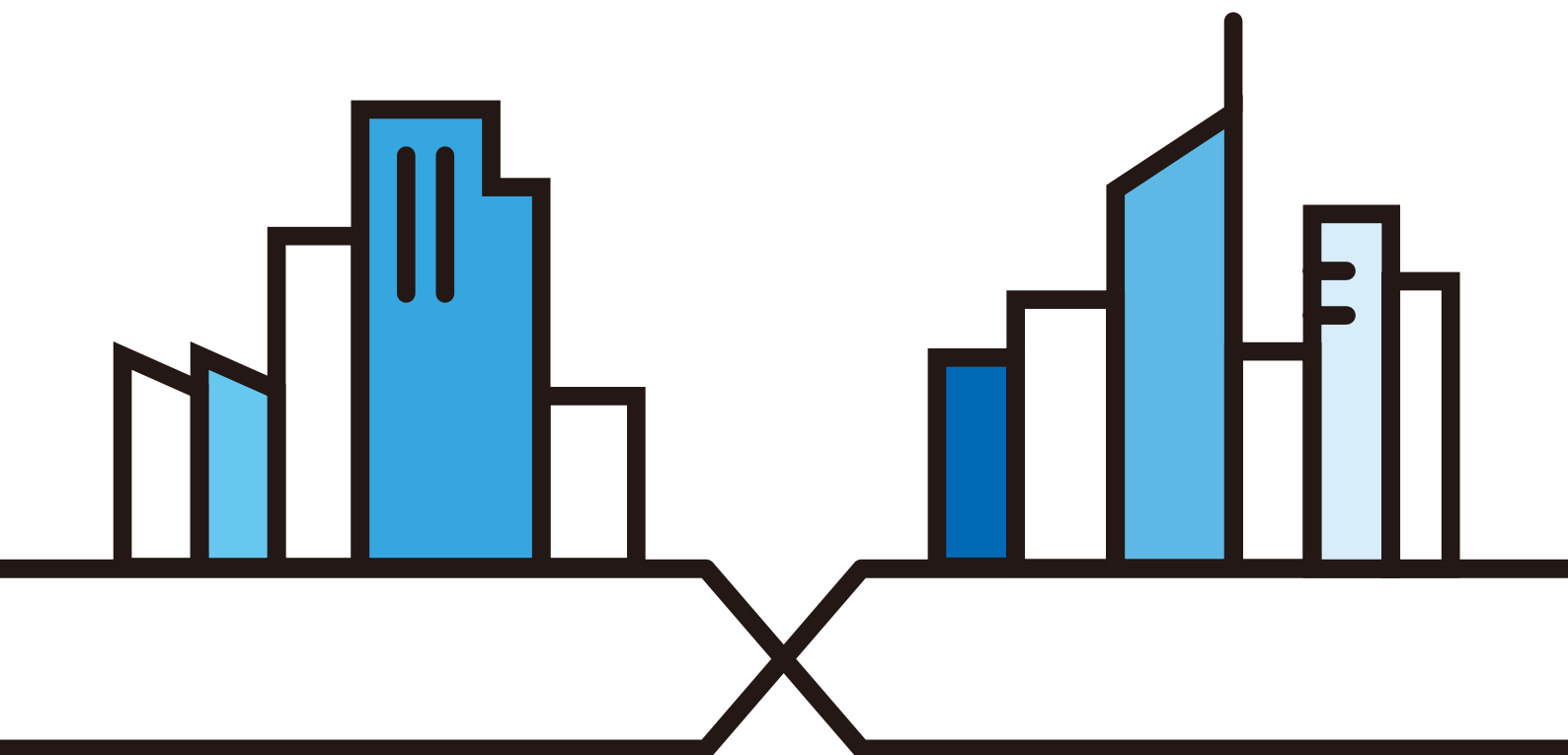

---

**IMPORTANT!**

**READ CAREFULLY BEFORE USE.**

**KEEP THIS GUIDE FOR FUTURE REFERENCE.**

This is a User's Guide for a series of products. Not all products support all firmware features. Screenshots and graphics in this book may differ slightly from your product due to differences in your product firmware or your computer operating system. Every effort has been made to ensure that the information in this manual is accurate.

### **Related Documentation**

- Quick Start Guide

The Quick Start Guide shows how to connect the Switch and access the Web Configurator.

- More Information

Go to [support.zyxel.com](http://support.zyxel.com) to find other information on the Switch.



# Document Conventions

## Warnings and Notes

These are how warnings and notes are shown in this guide.

**Warnings tell you about things that could harm you or your device.**









Note: Notes tell you other important information (for example, other things you may need to configure or helpful tips) or recommendations.

## Syntax Conventions

- The GS1200-5, GS1200-5HP v2, GS1200-8, and GS1200-8HP v2 may be referred to as the "Switch" in this guide.
- Product labels, screen names, field labels and field choices are all in **bold** font.
- A right angle bracket ( > ) within a screen name denotes a mouse click. For example, **QoS > Port-Based QoS** means you first click **QoS** in the navigation panel, then the **Port-Based QoS** sub menu to get to that screen.

## Icons Used in Figures

Figures in this user guide may use the following generic icons. The Switch icon is not an exact representation of your device.

Switch 	Generic Switch 	Generic Router 
IP Camera 	Firewall 	Cell Tower 
Printer 	Server 	

# Contents Overview

<b>User's Guide</b> .....	<b>1</b>
Getting to Know Your Switch .....	1
Hardware Installation .....	1
Hardware Panels .....	2
The Web Configurator .....	1
Initial Setup Example .....	6
<b>Technical Reference</b> .....	<b>1</b>
System .....	1
Port .....	4
VLAN .....	8
Link Aggregation .....	11
Mirroring .....	13
QoS .....	15
IGMP Snooping .....	19
Management .....	21
Troubleshooting .....	1

---

# Table of Contents

<b>Document Conventions</b> .....	1
<b>Contents Overview</b> .....	1
<b>Table of Contents</b> .....	1
<b>Part I: User's Guide</b> .....	<b>1</b>
<b>Chapter 1</b>	
<b>Getting to Know Your Switch</b> .....	<b>1</b>
1.1 Introduction .....	1
1.2 Applications .....	2
1.2.1 Bridging Application .....	2
1.2.2 VLAN Application Example .....	2
1.3 Ways to Manage the Switch .....	3
1.4 Good Habits for Managing the Switch .....	3
<b>Chapter 2</b>	
<b>Hardware Installation</b> .....	<b>1</b>
2.1 Installation Scenarios .....	1
2.2 Desktop Installation Procedure .....	1
<b>Chapter 3</b>	
<b>Hardware Panels</b> .....	<b>2</b>
3.1 Front Panel .....	2
3.2 Rear Panel .....	2
3.2.1 Power Connector .....	3
3.3 LEDs .....	4
<b>Chapter 4</b>	
<b>The Web Configurator</b> .....	<b>1</b>
4.1 Overview .....	1
4.2 System Login .....	1
4.3 The Web Configurator Layout .....	2
4.3.1 Change Your Password .....	4
4.4 Switch Lockout .....	4
4.5 Resetting the Switch .....	5
4.6 Logging Out of the Web Configurator .....	5

<b>Chapter 5</b>	
<b>Initial Setup Example .....</b>	<b>6</b>
5.1 Overview .....	6
5.1.1 Creating a VLAN .....	6
5.1.2 Setting Port VID .....	8
5.1.3 Power over Ethernet (PoE) Configuration .....	9
<b>Part II: Technical Reference.....</b>	<b>1</b>
<b>Chapter 6</b>	
<b>System.....</b>	<b>1</b>
6.1 Overview .....	1
6.2 System Screen .....	1
<b>Chapter 7</b>	
<b>Port .....</b>	<b>4</b>
7.1 Overview .....	4
7.1.1 What You Need to Know .....	4
7.2 Port Screen .....	5
<b>Chapter 8</b>	
<b>VLAN.....</b>	<b>8</b>
8.1 Overview .....	8
8.1.1 What You Need to Know .....	8
8.2 VLAN Screen .....	9
<b>Chapter 9</b>	
<b>Link Aggregation .....</b>	<b>11</b>
9.1 Overview .....	11
9.2 Link Aggregation Screen .....	11
<b>Chapter 10</b>	
<b>Mirroring.....</b>	<b>13</b>
10.1 Overview .....	13
10.2 Mirroring Screen .....	13
<b>Chapter 11</b>	
<b>QoS.....</b>	<b>15</b>
11.1 Overview .....	15
11.2 What You Need to Know .....	15
11.2.1 Port-Based QoS .....	15

11.2.2 IEEE 802.1p QoS .....	15
11.2.3 Weighted Round Robin Scheduling (WRR) .....	16
11.3 Port-Based QoS Screen .....	17
11.4 IEEE 802.1P QoS Screen .....	18
<b>Chapter 12</b>	
<b>IGMP Snooping .....</b>	<b>19</b>
12.1 Overview .....	19
12.2 IGMP Snooping Screen .....	19
<b>Chapter 13</b>	
<b>Management .....</b>	<b>21</b>
13.1 Overview .....	21
13.1.1 What You Need to Know .....	21
13.2 Management Screen .....	21
13.2.1 Firmware Upgrade Screen .....	23
<b>Chapter 14</b>	
<b>Troubleshooting.....</b>	<b>1</b>
14.1 Power, Hardware Connections, and LEDs .....	1
14.2 Switch Access and Login .....	2
14.3 Switch Configuration .....	4
Appendix A Customer Support .....	1
Appendix B Legal Information .....	1
<b>Index .....</b>	<b>1</b>

---

# PART I

## User's Guide

---



# CHAPTER 1

## Getting to Know Your Switch

### 1.1 Introduction

This chapter introduces the main features and applications of the Switch. The GS1200 Series consists of the following models:

- GS1200-5
- GS1200-5HP v2
- GS1200-8
- GS1200-8HP v2

The Switch has 5/8 ports. You can easily connect different devices, such as computers, network storage devices, IP cameras, print servers to your home network.

The PoE ports of the GS1200-5HP v2 and GS1200-8HP v2 support IEEE802.3at High Power over Ethernet (PoE) and IEEE802.3af PoE standard, to provide power to IP CAM, wall mounted AP, and other devices that may be far from a power outlet.

For an advanced user, the Switch also provides a utility like web configurator to give you an easy configuration for VLAN, QoS, basis system management, and firmware upgrade. The Switch is compliant with IEEE802.3az (Energy Efficient Ethernet Standard), and provides power-saving benefits without compromising performance.

Key feature differences between Switch models are as follows. Other features are common to all models.

Table 1 GS1200 Series Comparison Table

MODEL	GS1200-5	GS1200-5HP V2	GS1200-8	GS1200-8HP V2
Total Port Number	5	5	8	8
10/100/1000 Mbps PoE Ports	-	Ports 1-4	-	Ports 1-4
10/100/1000 Mbps Ethernet Ports	Ports 1-5	Port 5	Ports 1-8	Ports 5-8
PoE Feature	-	IEEE 802.3 af PoE  IEEE 802.3at High Power over Ethernet (PoE)	-	IEEE 802.3 af PoE  IEEE 802.3at High Power over Ethernet (PoE)
PoE Maximum Power	-	60W PoE power budget	-	60W PoE power budget
Power ON/OFF Switch	-	√	-	√
802.1p QoS and Port-Based QoS	√	√	√	√

Table 1 GS1200 Series Comparison Table

MODEL	GS1200-5	GS1200-5HP V2	GS1200-8	GS1200-8HP V2
IGMP Snooping v1/v2 and v3 Compatible	✓	✓	✓	✓
Broadcast Storm Control	✓	✓	✓	✓
Firmware Upgrade	✓	✓	✓	✓
Configuration Restore and Backup	✓	✓	✓	✓

## 1.2 Applications

This section shows a few examples of using the Switch in various network environments.

### 1.2.1 Bridging Application

In this example the Switch connects different company departments (**RD** and **Sales**) to the corporate backbone. It can alleviate bandwidth contention and eliminate server and network bottlenecks. All users that need high bandwidth can connect to high-speed department servers via the Switch.

**Figure 1** Bridging Application

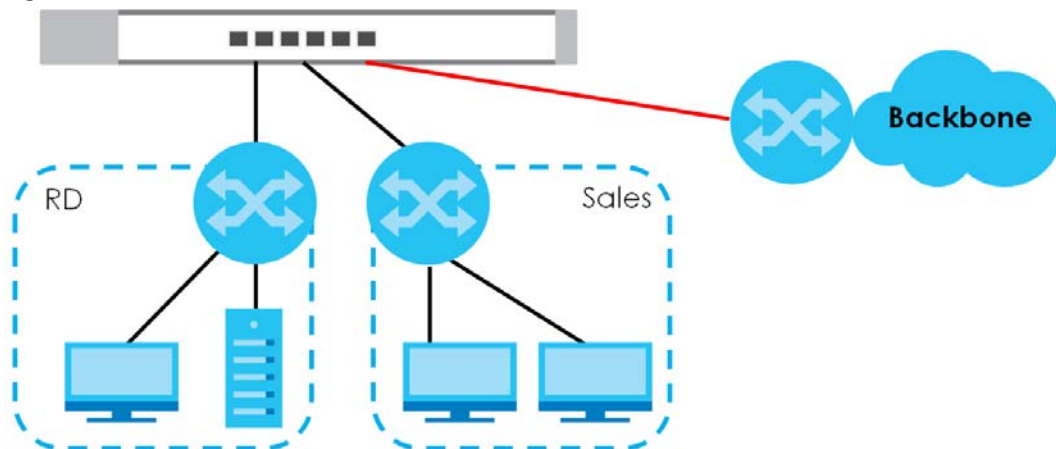

### 1.2.2 VLAN Application Example

A VLAN (Virtual Local Area Network) allows a physical network to be partitioned into multiple logical networks. Stations on a logical network belong to one or more groups. With VLAN, a station cannot directly talk to or hear from stations that are not in the same group(s) unless such traffic first goes through a router.

#### 1.2.2.1 Tag-based VLAN Example

Ports in the same VLAN group share the same frame broadcast domain, thus increasing network performance by reducing broadcast traffic. VLAN groups can be modified at any time by adding, moving or changing ports without any re-cabling.

Shared resources such as a server can be used by all ports in the same VLAN as the server. In the following figure only ports that need access to the server need to be part of VLAN1. Ports can belong to other VLAN groups too.

Figure 2 Shared Server Using VLAN Example

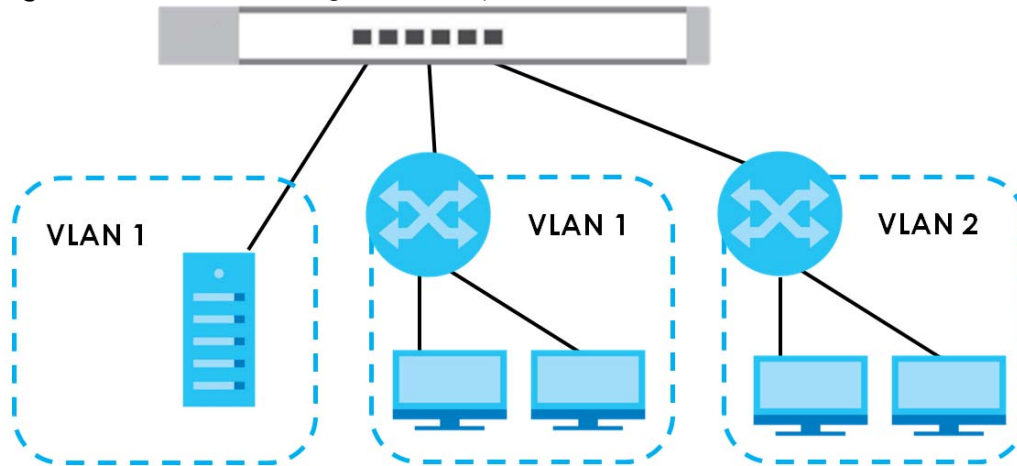

## 1.3 Ways to Manage the Switch

Use any of the following methods to manage the Switch.

- Web Configurator. This allows easy Switch setup and management using a (supported) web browser. See [Chapter 4 on page 1](#).

## 1.4 Good Habits for Managing the Switch

Do the following things regularly to make the Switch more secure and to manage the Switch more effectively.

- Change the password. Use a password that's not easy to guess and that consists of different types of characters, such as numbers and letters.
- Write down the password and put it in a safe place.
- Back up the configuration (and make sure you know how to restore it). Restoring an earlier working configuration may be useful if the device becomes unstable or even crashes. If you forget your password, you will have to reset the Switch to its factory default settings. If you backed up an earlier configuration file, you would not have to totally re-configure the Switch. You could simply restore your last configuration.

# CHAPTER 1

# Hardware Installation

## 1.1 Installation Scenarios

This chapter shows you how to install and connect the Switch.

The Switch can be placed on a desktop. Use the rubber feet in a desktop installation.

## 1.2 Desktop Installation Procedure

- 1 Make sure the Switch is clean and dry.
- 2 Set the Switch on a smooth, level surface strong enough to support the weight of the Switch and the connected cables. Make sure there is a power outlet nearby.
- 3 Make sure there is enough clearance around the Switch to allow air circulation and the attachment of cables and the power cord.

Note: Make sure you are using the correct type of Ethernet cable (Category 5e, 6UTP/STP, or better Ethernet cable).

# CHAPTER 2

## Hardware Panels

This chapter describes the front panel and rear panel of the Switch and shows you how to make the hardware connections.

### 2.1 Front Panel

The following figures show the front panels of the Switch.

**Figure 1** Front Panel: GS1200-5

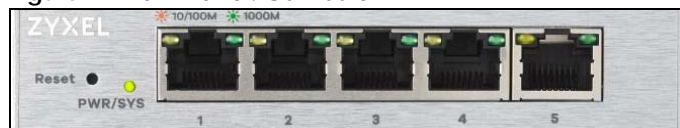

**Figure 2** Front Panel: GS1200-5HP v2



**Figure 3** Front Panel: GS1200-8



**Figure 4** Front Panel: GS1200-8HP v2



### 2.2 Rear Panel

The following figures show the rear panels of the Switch.

**Figure 5** Rear Panel: GS1200-5



**Figure 6** Rear Panel: GS1200-5HP v2



**Figure 7** Rear Panel: GS1200-8

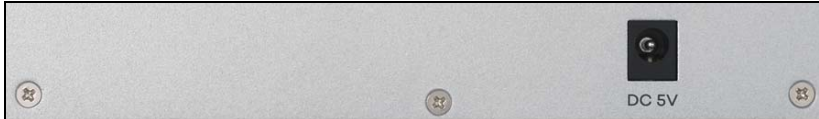

**Figure 8** Rear Panel: GS1200-8HP v2

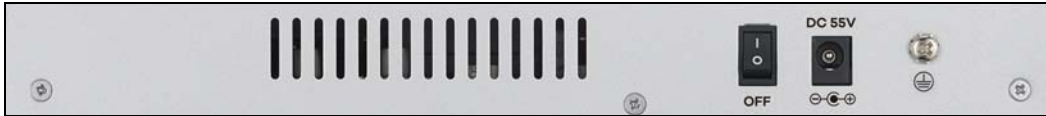

## 2.2.1 Power Connector

Note: Make sure you are using the correct power source as shown on the panel.

To connect power to the Switch, insert the female end of the power cord to the AC power receptacle on the rear panel. Connect the other end of the supplied power cord to a power outlet. Make sure that no objects obstruct the airflow.

## 2.3 LEDs

After you connect the power to the Switch, view the LEDs to ensure proper functioning of the Switch and as an aid in troubleshooting.

Table 1 LED Descriptions

LED	COLOR	STATUS	DESCRIPTION
PWR/SYS	Green	On	The system power is on.
		Blinking	The system is starting up.
		Off	The system power is off.
LINK/ACT	Amber (10/100 Mbps)	On	The port has a successful 10/100 Mbps or 1000 Mbps connection.
		Blinking	The system is transmitting data through the port.
	Green (1000 Mbps)	Blinking once a second	If you enable <b>Loop Detection</b> in the <b>Port</b> screen, the port in a loop state will blink fast.  If you enable <b>Loop Prevention</b> in the <b>Port</b> screen, all ports will blink fast. Later, the port in a loop state will be off. If a loop happens on two ports, all ports will blink fast. Later, the higher-numbered port will be off.
		Off	The port is disconnected or disabled.  If you enable <b>Loop Prevention</b> in the <b>Port</b> screen, and a loop happens on two ports, the higher-numbered port will be off.
PoE (GS1200-5HP v2 & GS1200-8HP v2)	Green	On	PoE is enabled and power is supplied to the connected PoE-enabled device.
		Off	PoE is disabled or power is not being supplied.
PoE Max (GS1200-5HP v2 & GS1200-8HP v2)	Amber	On	More than 50W has been supplied to the PoE-enabled devices, and the PoE power output is approaching the power budget.
		Off	Less than 50W has been supplied to the PoE-enabled devices.

# CHAPTER 1

## The Web Configurator

### 1.1 Overview

This section introduces the configuration and functions of the web configurator.

The web configurator is an HTML-based management interface that allows easy Switch setup and management via Internet browser. Use Internet Explorer 10.0 and later versions, Mozilla Firefox 46.0.1 and later versions, or Google Chrome 50.0 and later versions. The recommended screen resolution is 1024 by 768 pixels.

In order to use the web configurator you need to allow:

- Web browser pop-up windows from your device.
- JavaScript (enabled by default).
- Java permissions (enabled by default).

### 1.2 System Login

- 1 Start your web browser.
- 2 Type "http://" and the IP address of the Switch (for example, the default management IP address is 192.168.1.3) in the **Location** or **Address** field. Press [ENTER]. Your computer must be in the same subnet in order to access this website address.
- 3 The login screen appears. The default password is **1234**.

**Figure 1** Web Configurator: Login

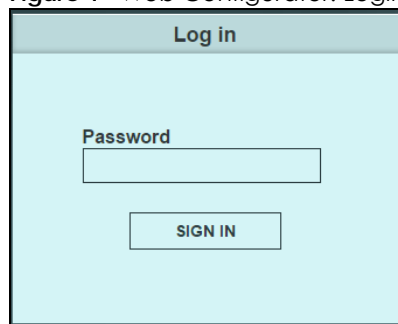

- 4 The following screen displays if you log into the Switch for the first time. Enter a new password, retype it to confirm and click **Apply** to view the first web configurator screen. Note that you can enter the default password 1234 again, if you don't want to change your password.



Figure 2 Web Configurator: Login

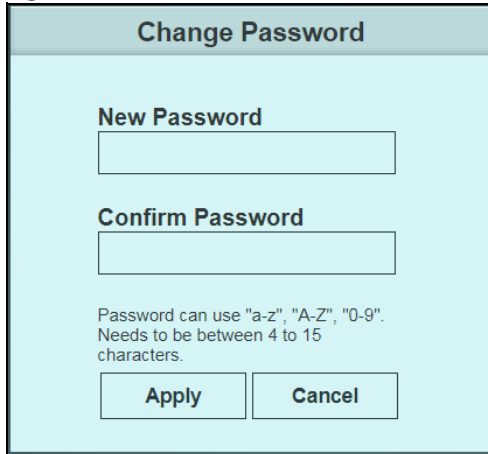

The screenshot shows a web form titled "Change Password" with a light blue background. It contains two input fields: "New Password" and "Confirm Password". Below the fields is a text instruction: "Password can use 'a-z', 'A-Z', '0-9'. Needs to be between 4 to 15 characters." At the bottom, there are two buttons: "Apply" and "Cancel".

## 1.3 The Web Configurator Layout

The **System** screen is the first screen that displays when you access the web configurator.

This guide uses GS1200-5HP v2 screens as an example. The screens may vary slightly for different models.

The following figure shows the navigating components of a web configurator screen.

Figure 3 Web Configurator Layout

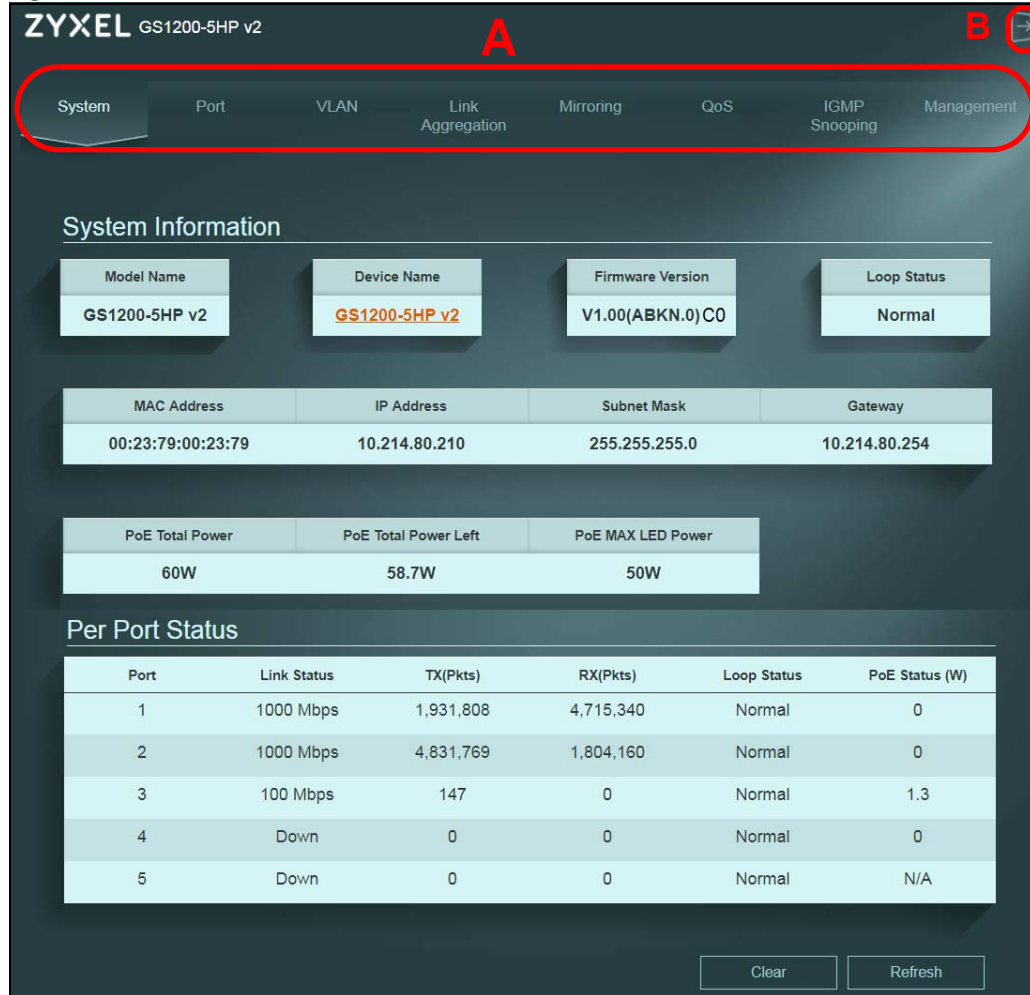

A - Click the menu items to open the screen in the main window.

B - Click this link to log out of the web configurator.

The following table describes the links in the navigation panel.

Table 1 Navigation Panel Links

LINK	DESCRIPTION
System	This link takes you to a screen that displays general system information, PoE status, and individual port statistics.
Port	This link takes you to a screen to enable <b>Broadcast Storm Control</b> and <b>Loop Prevention/Loop Detection</b> . You can also configure advanced settings, such as transmission speed, flow control, and PoE on a port.
VLAN	This link takes you to a screen where you can configure VLAN settings.
Link Aggregation	This link takes you to screens where you can logically aggregate physical links to form one logical and higher-bandwidth link.
Mirroring	This link takes you to a screen where you can copy traffic from one port or ports to another port so that you can examine the traffic from the first port without interference.
QoS	This link takes you to a screen where you can configure port-based or IEEE 802.1p QoS.

Table 1 Navigation Panel Links (continued)

LINK	DESCRIPTION
IGMP Snooping	This link takes you to a screen where you can configure IGMP snooping.
Management	This link takes you to screens where you can change the system login password, perform firmware upgrade and configuration file maintenance as well as reboot the system. You can also configure the IP address and subnet mask.

### 1.3.1 Change Your Password

After you log in for the first time, it is recommended you change the default administrator password. Click **Management** to display the next screen to change your login password.

Figure 4 Change Administrator Login Password

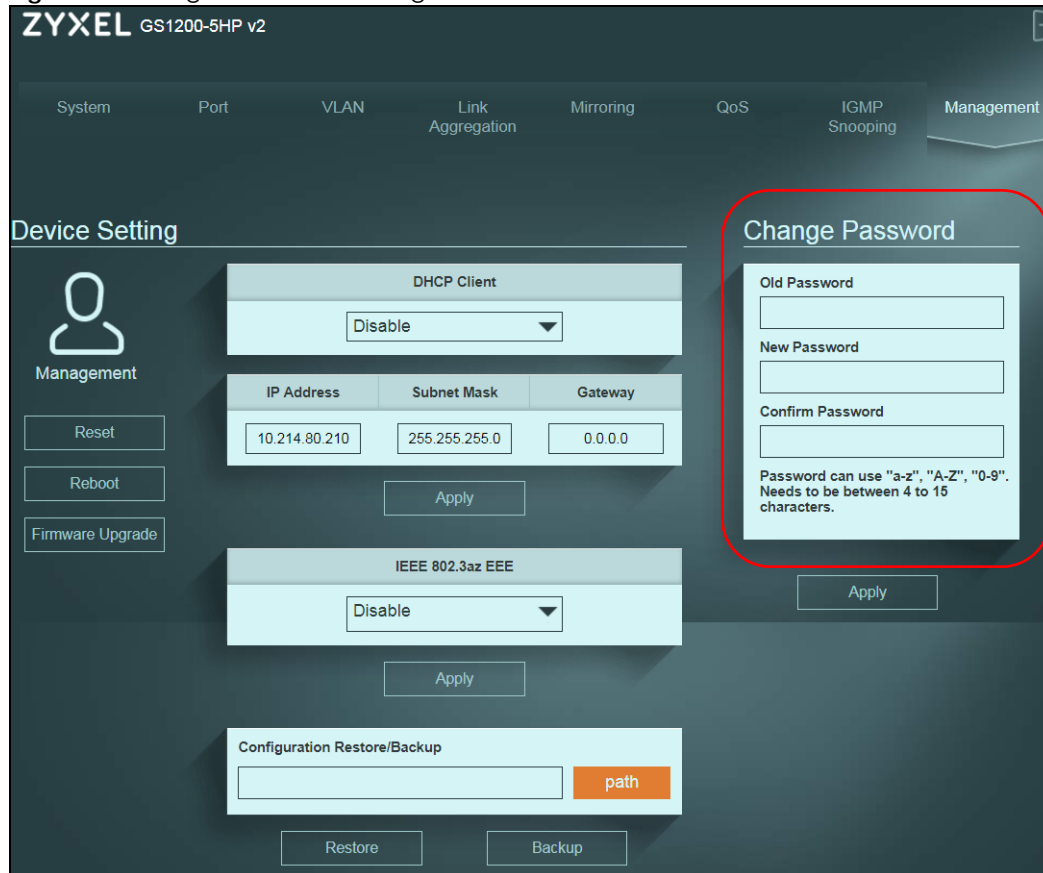

## 1.4 Switch Lockout

You could block yourself (and all others) from managing the Switch if you do one of the following:

- 1 Remove all ports from the management VLAN (default is VLAN 1).
- 2 Forget the password and/or IP address.

- 3 You forgot to log out of the Switch from a computer before logging in again on another computer.

Note: Be careful not to lock yourself and others out of the Switch.

## 1.5 Resetting the Switch

If you forget the administrator password or cannot access the Web Configurator, you will need to use the **Reset** button at the front panel of the device to reset the Switch back to the factory defaults.

This means that you will lose all configurations that you had previously and the password will be reset to "1234". IP address will also be reset to 192.168.1.3

- 1 Make sure the **PWR/SYS** LED is on (not blinking).
- 2 To set the device back to the factory default settings, press the **Reset** button for ten seconds or until the **PWR/SYS** LED begins to blink and then release it. When the **PWR/SYS** LED begins to blink, the defaults have been restored and the device restarts.

## 1.6 Logging Out of the Web Configurator

Click the **Logout** icon in a screen to exit the web configurator. You have to log in with your password again after you log out. This is recommended after you finish a management session for security reasons.

# CHAPTER 2

## Initial Setup Example

### 2.1 Overview

This chapter shows how to set up the Switch for an example network.

The following lists the configuration steps for the initial setup:

- [Creating a VLAN](#)
- [Setting Port VID](#)
- [Power over Ethernet \(PoE\) Configuration](#)

#### 2.1.1 Creating a VLAN

VLANs confine broadcast frames to the VLAN group in which the port(s) belongs. You can create a VLAN group with fixed port members to do this.

In this example, you want to configure port 1 as a member of VLAN 2.

**Figure 5** Initial Setup Network Example: VLAN

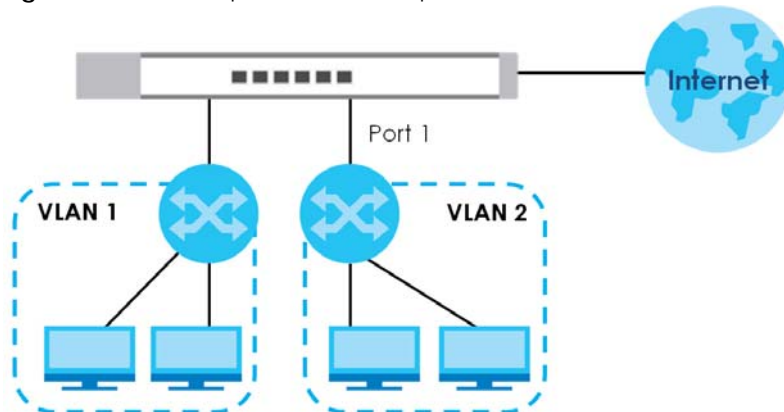

- 1 Click **VLAN** in the navigation panel and click the **Create New VLAN** button.

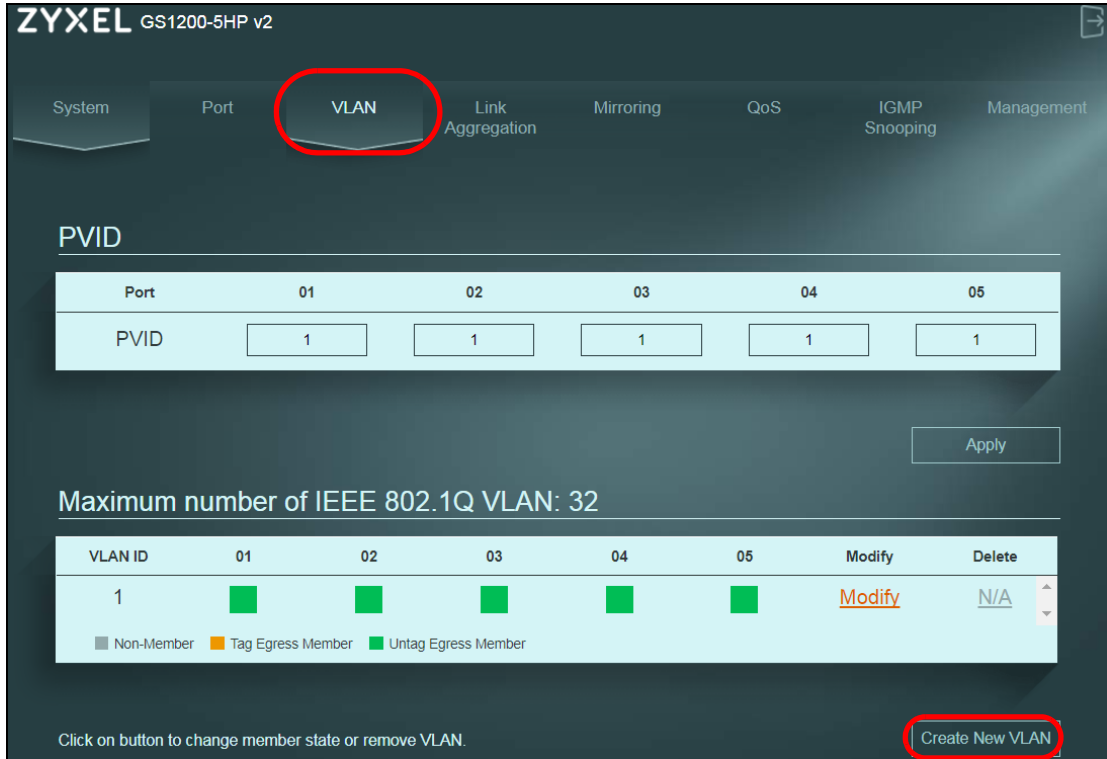

- 2 Enter 2 in the **VLAN ID** field for the VLAN2 network.
- 3 Since the VLAN2 network is connected to port 1 on the Switch, configure port 1 to be a permanent member of the VLAN. To ensure that VLAN-unaware devices (such as computers and hubs) can receive frames properly, set the port's box color to green to set the Switch to remove VLAN tags before sending.
- 4 Change the box color of other ports to gray.
- 5 Click **Apply** to save the settings.

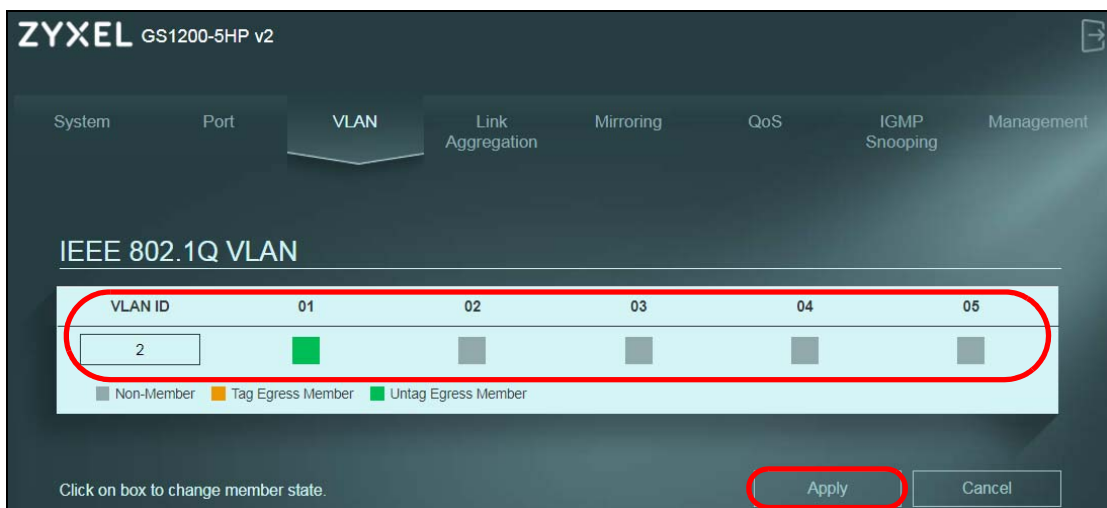

## 2.1.2 Setting Port VID

Use PVID to add a tag to incoming untagged frames received on that port so that the frames are forwarded to the VLAN group that the tag defines.

In the example network, configure 2 as the port VID on port 1 so that any untagged frames received on that port get sent to VLAN 2.

**Figure 6** Initial Setup Network Example: Port VID

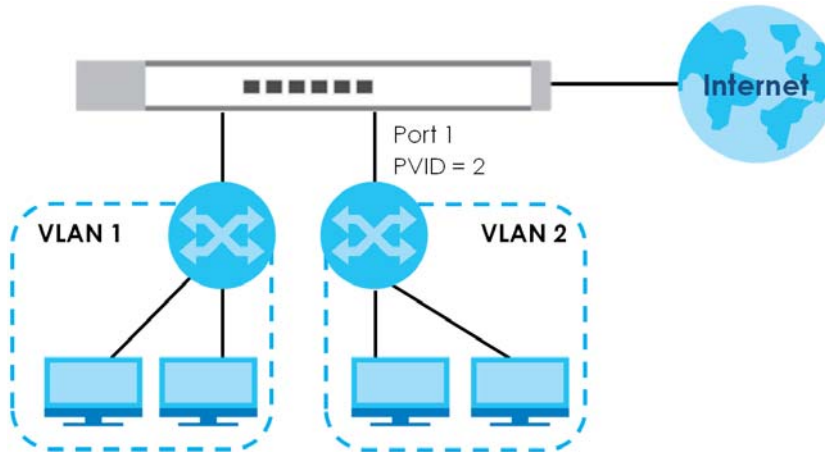

- 1 Click **VLAN** in the navigation panel.
- 2 Enter 2 in the **PVID** field for port 2 and click **Apply** to save your changes back to the Switch.

**ZYXEL GS1200-5HP v2**

System Port **VLAN** Link Aggregation Mirroring QoS IGMP Snooping Management

**PVID**

Port	01	02	03	04	05
PVID	2	1	1	1	1

Apply

Maximum number of IEEE 802.1Q VLAN: 32

VLAN ID	01	02	03	04	05	Modify	Delete
1	■	■	■	■	■	Modify	N/A
2	■	■	■	■	■	Modify	Delete

■ Non-Member ■ Tag Egress Member ■ Untag Egress Member

Click on button to change member state or remove VLAN.

Create New VLAN

## 2.1.3 Power over Ethernet (PoE) Configuration

This example is for GS1200-5HP v2 and GS1200-8HP v2.

See [Figure 21 on page 5](#) for an example of using PoE to power devices.

Before connecting devices that require PoE to the PoE ports, PD (Powered Devices), you must enable PoE on those ports.

- 1 Click **Port** in the navigation panel.
- 2 Go to **Port Setting**, select **Enable** or **Disable** for ports that will supply power to PDs in the **PoE** field, and click **Apply** to save your changes back to the Switch.

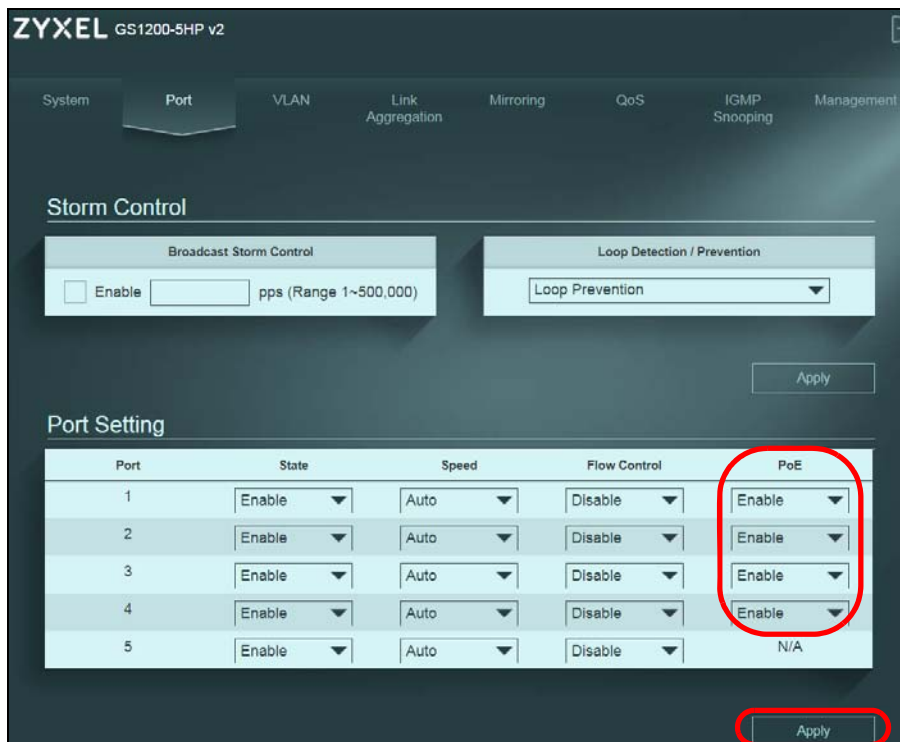

- 3 After connecting the PDs to the **PoE** ports, you can go to the **System** screen to check the amount of power the PDs are consuming (**PoE Status**), the maximum power the Switch can provide (**PoE Total Power**), and so on.  
See [Section 6.2 on page 1](#) for more information about **PoE**.

Note: The total power the Switch can supply is 60W, and it's shown in the **PoE Total Power** field. The maximum power a PoE port can supply is 30W.

Note: The Switch allocates power to PDs in the order that they were connected.

Note: When the total power requested by the PDs exceeds the total PoE power budget on the Switch, the last PD connected to the Switch won't be powered up.



**ZYXEL** GS1200-5HP v2

System | Port | VLAN | Link Aggregation | Mirroring | QoS | IGMP Snooping | Management

### System Information

Model Name	Device Name	Firmware Version	Loop Status
GS1200-5HP v2	GS1200-5HP v2	V1.00(ABKN.0)C0	Normal

MAC Address	IP Address	Subnet Mask	Gateway
00:23:79:00:23:79	10.214.80.210	255.255.255.0	10.214.80.254

PoE Total Power	PoE Total Power Left	PoE MAX LED Power
60W	60W	50W

### Per Port Status

Port	Link Status	TX(Pkts)	RX(Pkts)	Loop Status	PoE Status (W)
1	1000 Mbps	1,931,808	4,715,340	Normal	0
2	1000 Mbps	4,831,769	1,804,160	Normal	0
3	100 Mbps	147	0	Normal	1.3
4	Down	0	0	Normal	0
5	Down	0	0	Normal	N/A

Clear Refresh

---

# PART I

## Technical Reference

---

# CHAPTER 1

# System

## 1.1 Overview

This chapter describes the screens for system status, and port details.

## 1.2 System Screen

The **System** screen displays when you log into the Switch or click **System** at the top of the web configurator. The **System** screen displays the Switch's general device information, PoE status, and the port statistics.

Figure 1 System

The screenshot shows the ZYXEL GS1200-5HP v2 web interface. At the top, there is a navigation menu with tabs for System, Port, VLAN, Link Aggregation, Mirroring, QoS, IGMP Snooping, and Management. The 'System' tab is selected. Below the navigation menu, the 'System Information' section displays several key metrics in a grid format:

- Model Name: GS1200-5HP v2
- Device Name: GS1200-5HP v2
- Firmware Version: V1.00(ABKN.0)C0
- Loop Status: Normal

Below this, a table shows network configuration details:

MAC Address	IP Address	Subnet Mask	Gateway
00:23:79:00:23:79	10.214.80.210	255.255.255.0	10.214.80.254

Next, another table displays PoE power statistics:

PoE Total Power	PoE Total Power Left	PoE MAX LED Power
60W	58.7W	50W

The 'Per Port Status' section contains a table with the following data:

Port	Link Status	TX(Pkts)	RX(Pkts)	Loop Status	PoE Status (W)
1	1000 Mbps	1,931,808	4,715,340	Normal	0
2	1000 Mbps	4,831,769	1,804,160	Normal	0
3	100 Mbps	147	0	Normal	1.3
4	Down	0	0	Normal	0
5	Down	0	0	Normal	N/A

At the bottom right of the screen, there are 'Clear' and 'Refresh' buttons.

The following table describes the labels in this screen.

Table 1 System

LABEL	DESCRIPTION
System Information	
Model Name	This field displays the model name of this Switch.
Device Name	<p>This field displays the name used to identify the Switch on any network.</p> <p>The device name is a link that you can click to open a screen where you can change the name. Enter a descriptive name of up to 14 characters. Also, spaces and the following special characters listed in the brackets [ " &lt; ^ \$   &amp; ; \ / : * ? ' ] are not allowed.</p> <p>Note: You must enter a descriptive name to identify the Switch.</p> 
Firmware Version	This field displays the version number and date of the firmware the Switch is currently running.
Loop Status	This field displays whether the Switch is in a loop state.
MAC Address	This field displays the MAC addresses of the Switch.
IP Address	<p>The Switch needs an IP address for it to be managed over the network. The factory default IP address is 192.168.1.3.</p> <p>This field displays the Switch's current IPv4 address.</p>
Subnet Mask	<p>The subnet mask specifies the network number portion of an IP address. The factory default subnet mask is 255.255.255.0.</p> <p>This field displays the Switch's subnet mask. -The subnet mask is a link that you can click to open a screen where you can change the IP address and subnet mask.</p>
Gateway	The gateway is a router or switch on the same network segment as the device's LAN or WAN port. The gateway helps forward packets to their destinations.
PoE Total Power (GS1200-5HP v2 & GS1200-8HP v2)	This field displays the total power the Switch can provide to the connected PoE-enabled devices on the PoE ports.
PoE Total Power Left (GS1200-5HP v2 & GS1200-8HP v2)	This field displays the amount of power the Switch can still provide for PoE.

Table 1 System (continued)

LABEL	DESCRIPTION
PoE MAX LED Power  (GS1200-5HP v2 & GS1200-8HP v2)	This field displays the point when the <b>PoE MAX</b> LED will turn on, indicating the Switch is reaching its maximum power.  When the total power requested by the PoE-enabled devices exceeds the total PoE power budget on the Switch, the last PoE-enabled device connected to the Switch won't be powered up.  For example, the first PoE-enabled device connected to port 1 requires 20W, the second one connected to port 2 requires 20W, and the third one connected to port 3 requires 25W. In this case, the total power consumption is 65W which exceeds the maximum power the Switch can supply. Therefore, the third PoE-enabled device won't be powered up as it was connected last.
Per Port Status	
Port	This identifies the Ethernet port on the Switch.
Link status	This field displays the current status or speed (either 10 Mbps, 100 Mbps or 1000 Mbps) of each port.
TX-(Pkts)	This field shows the number of transmitted frames on this port.
RX-(Pkts)	This field shows the number of received frames on this port.
Loop Status	It displays <b>Loop</b> when the Switch detects a loop on the port. Otherwise, it displays <b>Normal</b> .
PoE Status (W)  (GS1200-5HP v2 & GS1200-8HP v2)	This field displays the amount of power the Switch is currently supplying to the PoE-enabled device connected to the port.
Clear	Click this button to clear the statistics in the TX(Pkts) and RX(Pkts) fields.
Refresh	Click this button to update the information in this screen.

# CHAPTER 2

## Port

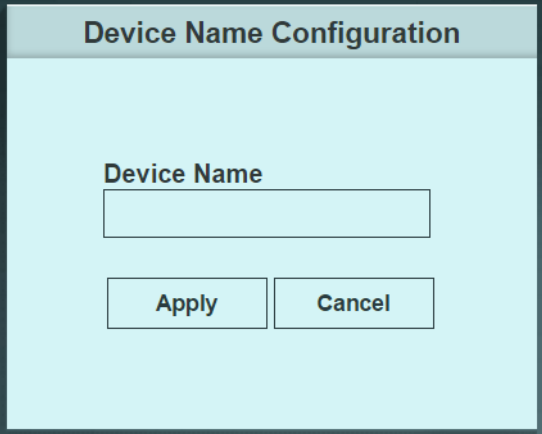
### 2.1 Overview

This chapter introduces and shows you how to configure the broadcast storm control feature and use loop prevention or loop detection to prevent loops in your network. In addition, you can configure transmission speed, flow control, and PoE on a port.

#### 2.1.1 What You Need to Know

Read this section to know more about **Loop Detection**, **Loop Prevention**, broadcast storm control, and PoE.

##### 2.1.1.1 Loop Detection and Loop Prevention

A switch loop happens if there is more than one connection between two ports on the same switch or between 2 switches connected together. If this happens, broadcasts are continually rebroadcast and could flood the network. You must break the loop by stopping multiple paths between two switch ports.

**Figure 2** Our Switch Has Two Ports Connected with Same Cable

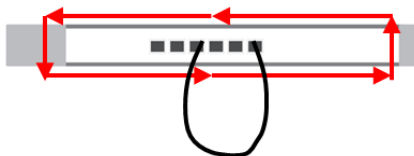

**Figure 3** Connected Switch Has Two Ports Connected with Same Cable

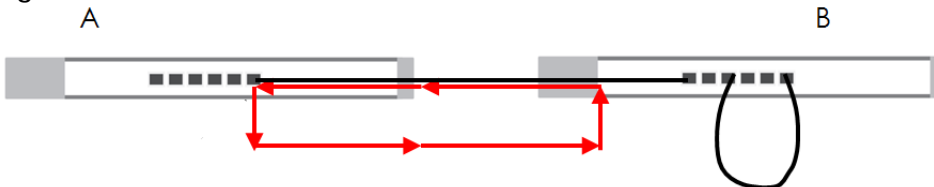

**Figure 4** Two Connections between Switches without Spanning Tree Protocol (STP)

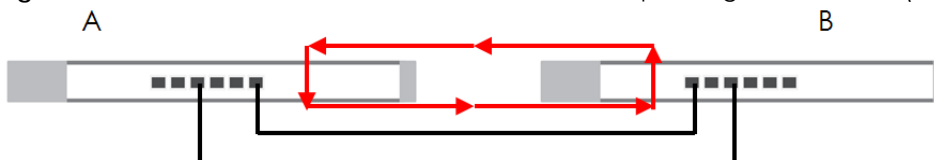

**Loop Detection** allows the Switch to discover a loop if it happens, and create a log. **Loop Prevention** allows the Switch to shut down a port automatically if it discover a loop on that port. See [Section 3.3 on page 4](#) for more information about LEDs.

### 2.1.1.2 Broadcast Storm Control

Broadcast storm control limits the number of broadcast packets the Switch receives per second on the ports. When the maximum number of allowable broadcast packets is reached per second, the subsequent packets are discarded. Enable this feature to reduce broadcast packets in your network. You can specify limits on each port.

### 2.1.1.3 PoE (GS1200-5HP v2 & GS1200-8HP v2)

The Switch supports both the IEEE 802.3af Power over Ethernet (PoE) and IEEE 802.3at High Power over Ethernet (PoE) standards. A PoE-enabled switch is a Power Sourcing Equipment (PSE), because it provides a source of power via its Ethernet ports. A powered device (PD) is a device such as an access point, IP phone, or IP camera, that receives PoE (Power over Ethernet) power from a PSE through its Ethernet port.

In the figure below, the IP camera and IP phone are PDs getting their power directly from the Switch PSE. Aside from minimizing the need for cables and wires, PoE removes the hassle of trying to find a nearby electric outlet to power up devices.

**Figure 5** Powered Device Example

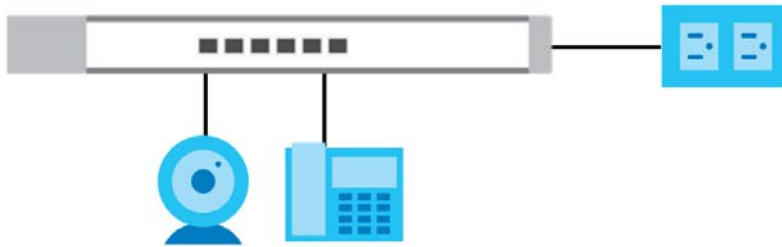

## 2.2 Port Screen

Click **Port** in the navigation panel to open the following screen.

Figure 6 Port

**Storm Control**

**Broadcast Storm Control**

Enable  pps (Range 1~500,000)

**Loop Detection / Prevention**

Loop Prevention

Apply

**Port Setting**

Port	State	Speed	Flow Control	PoE
1	Enable	Auto	Disable	Enable
2	Enable	Auto	Disable	Enable
3	Enable	Auto	Disable	Enable
4	Enable	Auto	Disable	Enable
5	Enable	Auto	Disable	N/A

Apply

The following table describes the labels in this screen.

Table 2 Port

LABEL	DESCRIPTION
Storm Control	
Broadcast Storm Control	Enable traffic storm control on the Switch by specifying how many broadcast packets a port receives per second.
Loop Detection / Prevention	Select <b>Loop Detection</b> to allow the Switch to detect a loop on the port. The port becomes active when the loop disappears. Select <b>Loop Prevention</b> to allow the Switch to shut down a port automatically when it detects a loop on the port. The port becomes active when the loop disappears. Select <b>Off</b> to disable this feature.
Apply	Click this button to save your changes to the Switch.
Port Setting	
Port	This identifies the Ethernet port on the Switch.
State	Select <b>Enable</b> to enable the port or <b>Disable</b> to disable it.
Speed	Select the speed of the Ethernet connection on this port. The choices are <b>Auto</b> , <b>10 Mbps</b> , and <b>100 Mbps</b> . Select <b>Auto</b> to have the Switch obtain the connection speed of up to 1000 Mbps.



Table 2 Port (continued)

LABEL	DESCRIPTION
Flow Control	<p>A concentration of traffic on a port decreases port bandwidth and overflows buffer memory causing packet discards and frame losses. Flow Control is used to regulate transmission of signals to match the bandwidth of the receiving port.</p> <p>The Switch uses IEEE802.3x flow control in full duplex mode and backpressure flow control in half duplex mode.</p> <p>IEEE802.3x flow control is used in full duplex mode to send a pause signal to the sending port, causing it to temporarily stop sending signals when the receiving port memory buffers fill.</p> <p>Back Pressure flow control is typically used in half duplex mode to send a "collision" signal to the sending port (mimicking a state of packet collision) causing the sending port to temporarily stop sending signals and resend later. Select the check box to enable it.</p>
PoE (GS1200-5HP v2 & GS1200-8HP v2)	Select <b>Enable</b> to provide power to a PoE-enabled device connected to the port or <b>Disable</b> so the port cannot receive power from the Switch.
Apply	Click this button to save your changes to the Switch.

# CHAPTER 3

# VLAN

## 3.1 Overview

This chapter shows you how to configure VLAN settings.

### 3.1.1 What You Need to Know

Read this section to know more about VLAN and how to configure the screens.

#### 3.1.1.1 IEEE 802.1Q Tagged VLANs

A tagged VLAN uses an explicit tag (VLAN ID) in the MAC header to identify the VLAN membership of a frame across bridges - they are not confined to the switch on which they were created. The VLANs can be created statically by hand or dynamically through GVRP. The VLAN ID associates a frame with a specific VLAN and provides the information that switches need to process the frame across the network. A tagged frame is four bytes longer than an untagged frame and contains two bytes of TPID (Tag Protocol Identifier, residing within the type/length field of the Ethernet frame) and two bytes of TCI (Tag Control Information, starts after the source address field of the Ethernet frame).

The CFI (Canonical Format Indicator) is a single-bit flag, always set to zero for Ethernet switches. If a frame received at an Ethernet port has a CFI set to 1, then that frame should not be forwarded as it is to an untagged port. The remaining twelve bits define the VLAN ID, giving a possible maximum number of 4,096 VLANs. Note that user priority and VLAN ID are independent of each other. A frame with VID (VLAN Identifier) of null (0) is called a priority frame, meaning that only the priority level is significant and the default VID of the ingress port is given as the VID of the frame. Of the 4096 possible VIDs, a VID of 0 is used to identify priority frames and value 4095 (FFF) is reserved, so the maximum possible VLAN configurations are 4,094.

TPID	User Priority	CFI	VLAN ID
2 Bytes	3 Bits	1 Bit	12 bits

### Forwarding Tagged and Untagged Frames

Each port on the Switch is capable of passing tagged or untagged frames. To forward a frame from an 802.1Q VLAN-aware switch to an 802.1Q VLAN-unaware switch, the Switch first decides where to forward the frame and then strips off the VLAN tag. To forward a frame from an 802.1Q VLAN-unaware switch to an 802.1Q VLAN-aware switch, the Switch first decides where to forward the frame, and then inserts a VLAN tag reflecting the ingress port's default VID. The default PVID is VLAN 1 for all ports, but this can be changed.

A broadcast frame (or a multicast frame for a multicast group that is known by the system) is duplicated only on ports that are members of the VID (except the ingress port itself), thus confining the broadcast to a specific domain.

## 3.2 VLAN Screen

Use this screen to view and configure VLAN settings for the Switch. Click **VLAN** in the navigation panel to open the following screen.

Note: You could block yourself (and all others) from managing the Switch if you remove all ports from the management VLAN (VLAN 1 by default).

Note: Make sure the port through which you connect your computer and access the Switch's web configurator is in VLAN 1.

Figure 7 VLAN



The following table describes the labels in this screen.

Table 3 VLAN

LABEL	DESCRIPTION
PVID	
Port	This field displays the port number.
PVID	A PVID (Port VLAN ID) is a tag that adds to incoming untagged frames received on a port so that the frames are forwarded to the VLAN group that the tag defines. Enter a number between 1 and 4094 as the port VLAN ID.
Apply	Click this button to save your PVID settings to the Switch.
Maximum number of IEEE 802.1Q VLAN	This shows the maximum number of IEEE 802.1Q VLANs you can have on the Switch.

Table 3 VLAN (continued)

LABEL	DESCRIPTION
VLAN ID	This is the ID number of the VLAN group. Enter a number between 1 and 4094 as the VLAN ID.
01 ~ 08 01 ~ 05	This displays the ports that are participating in a VLAN. A tagged port is orange, an untagged port is green and ports not participating in a VLAN are gray.
Modify	Click <b>Modify</b> to edit the VLAN settings.
Delete	Click <b>Delete</b> to remove the VLAN group. You cannot delete the default VLAN.
Create New VLAN	Click this button to configure a new IEEE 802.1Q VLAN for the Switch.

## How to add ports to an IEEE 802.1Q VLAN

By default, all ports on the Switch are in VLAN 1. If you want to have a port belong to another VLAN as well, say VLAN 123, you need to create a VLAN first, and then add the port to the VLAN.

- 1 Click **Create New VLAN** and enter a VLAN ID number (123 in this example).
- 2 Click the port's check box to add it to the VLAN group by changing the box color to green (untagging) or orange (tagging). Set the port's box color to gray if the port is not a member of the VLAN group.
- 3 Click **Apply** to save your changes.

**IEEE 802.1Q VLAN**

VLAN ID	01	02	03	04	05
123	Non-Member	Tag Egress Member	Untag Egress Member	Tag Egress Member	Tag Egress Member

Non-Member  
 Tag Egress Member  
 Untag Egress Member

Click on box to change member state.

Apply   Cancel

# CHAPTER 4

## Link Aggregation

### 4.1 Overview

This chapter shows you how to logically aggregate physical links to form one logical and higher bandwidth link.

Link aggregation is the grouping of physical ports into one logical higher-capacity link. You may want to trunk ports if for example, it is cheaper to use multiple lower-speed links than to under-utilize a high-speed, but more costly, single-port link.

### 4.2 Link Aggregation Screen

Use this screen to configure static link aggregation.

Figure 8 Link Aggregation (GS1200-5 & GS1200-5HP)

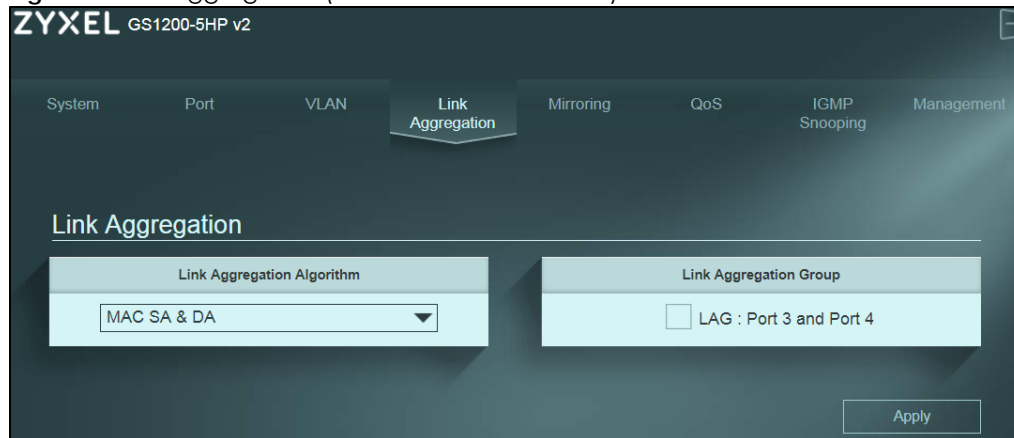
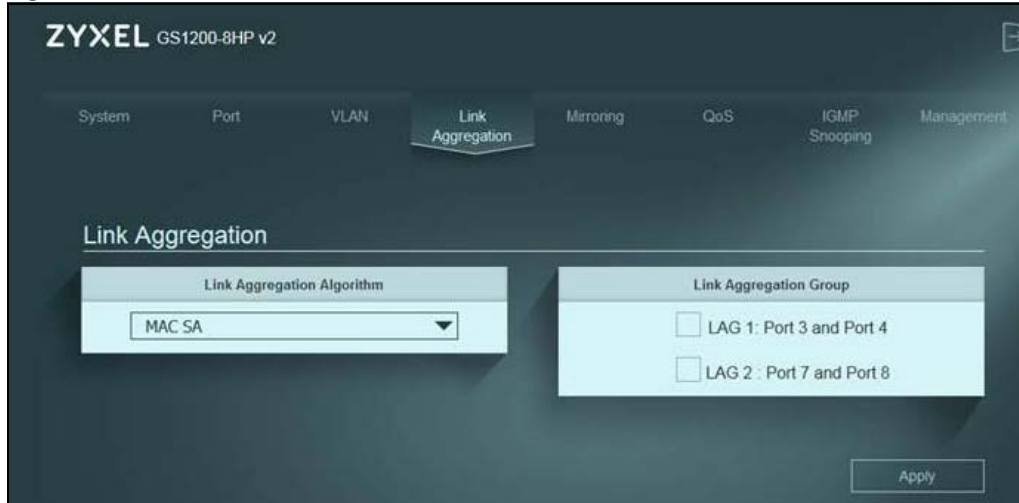

Figure 9 (GS1200-8 &amp; GS1200-8HP)



The following table describes the labels in this screen.

Table 4 Link Aggregation

LABEL	DESCRIPTION
Link Aggregation	
Link Aggregation Algorithm	<p>Select the outgoing traffic distribution type. Packets from the same source and/or to the same destination are sent over the same link within the trunk. By default, the Switch uses the <b>MAC SA &amp; DA</b> distribution type. If the Switch is behind a router, the packet's destination or source MAC address will be changed. In this case, set the Switch to distribute traffic based on its IP address to make sure port trunking can work properly.</p> <p>Select <b>MAC SA</b> to distribute traffic based on the packet's source MAC address.</p> <p>Select <b>MAC DA</b> to distribute traffic based on the packet's destination MAC address.</p> <p>Select <b>MAC SA &amp; DA</b> to distribute traffic based on a combination of the packet's source and destination MAC addresses.</p>
Link Aggregation Group	<p>The field identifies the default link aggregation group(s) the Switch supports.</p> <p>Note: By default, the GS1200-5 and GS1200-5HP v2 have a link aggregation group containing ports 3 and 4.</p> <p>Note: By default, the GS1200-8 and GS1200-8HP v2 have two link aggregation groups. One contains ports 3 and 4, and the other contains ports 7 and 8.</p> <p>Note: Make sure the ports in a link aggregation group must have the same PVID and VLAN ID.</p>
Apply	Click this button to save your changes to the Switch.

# CHAPTER 5

## Mirroring

### 5.1 Overview

This chapter discusses port mirroring setup screens.

Port mirroring allows you to copy a traffic flow to a monitor port (the port you copy the traffic to) in order that you can examine the traffic from the monitor port without interference.

### 5.2 Mirroring Screen

Use this screen to select a monitor port and specify the traffic flow to be copied to the monitor port.

Note: A port can't be the monitor port and the mirrored port at the same time.

Figure 10 Mirroring

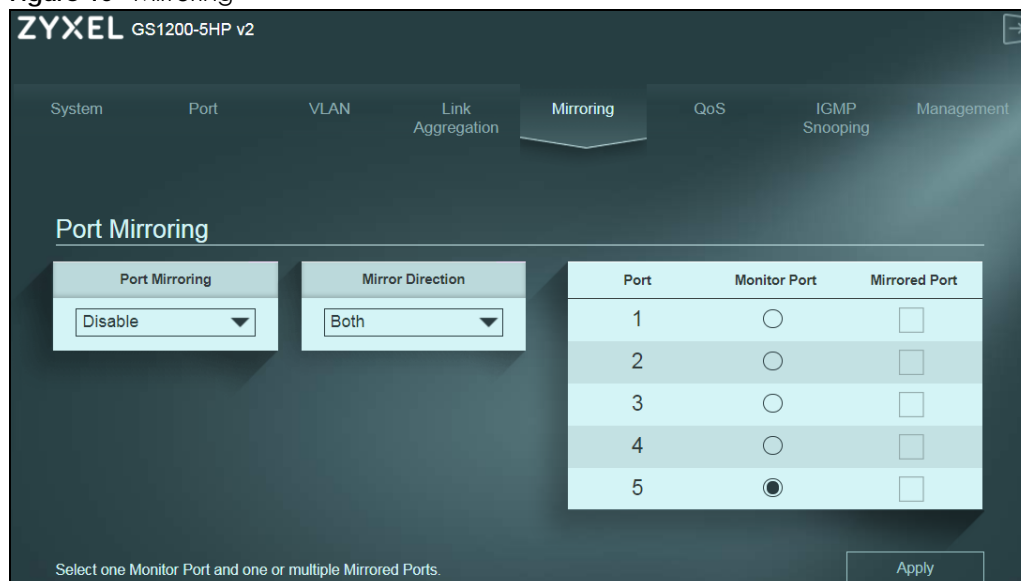

The following table describes the labels in this screen.

Table 5 Mirroring

LABEL	DESCRIPTION
Port Mirroring	Select <b>Enable</b> to activate port mirroring on the Switch or <b>Disable</b> to disable the feature.
Mirror Direction	Specify the direction of the traffic to mirror by selecting from the drop-down list box. Choices are <b>Egress</b> (outgoing), <b>Ingress</b> (incoming) and <b>Both</b> .

Table 5 Mirroring (continued)

LABEL	DESCRIPTION
Port	This field displays the port number.
Monitor Port	The monitor port is the port you copy the traffic to in order to examine it in more detail without interfering with the traffic flow on the original port(s).  Note: Select one monitor port.
Mirrored Port	Select this option to mirror the traffic on a port.  Note: Select one or multiple mirrored ports.
Apply	Click this button to save your changes to the Switch.



# CHAPTER 6

## QoS

### 6.1 Overview

This chapter introduces the configuration and functions of the **QoS** (Quality of Service) screen.

The QoS (Quality of Service) feature allows you to prioritize the flow of data passing through the Switch. Occasionally, data might be delayed, depending on the volume of traffic and the capacity of the equipment. Numeric and text data are usually not affected by delays, because they are reassembled at the destination. However, when VoIP and streaming videos are reassembled, they might have some troublesome gaps. Without QoS, all traffic data is equally likely to be dropped when the network is congested. This can cause a reduction in network performance and make the network inadequate for time-critical applications such as VOD (Video on Demand).

You can enable QoS to have the Switch assign each packet a priority and then queues the packet accordingly. Packets assigned a high priority are processed more quickly than those with low priority if there is congestion, allowing time-sensitive applications to flow more smoothly. Time-sensitive applications include both those that require a low level of latency (delay) and a low level of jitter (variations in delay) such as Voice over IP (VoIP) or Internet gaming, and those for which jitter alone is a problem such as Internet radio or streaming video.

### 6.2 What You Need to Know

The Switch can put packets into the queues according to the port on which the packet is received or the priority tag in the packet.

#### 6.2.1 Port-Based QoS

The Port-Based QoS feature assigns priority to data transmitted through a particular port. When the data arrives to a port it begins a queue. Therefore the Switch has a queue for each port. If data arrives at the same time to all ports, ports with higher priority will be first to transmit the data received. The higher the priority of the port, the less delays the data passing through will have.

#### 6.2.2 IEEE 802.1p QoS

IEEE 802.1p defines a 3-bit field called PCP (Priority Code Point) within the IEEE 802.1Q VLAN tag, which is also referred to as a CoS (Class of Service) value and indicates the frame priority level. IEEE 802.1p QoS uses the priority value (from 0 to 7) to define up to eight traffic types. That is, each priority level defines a

class of service. The table below shows the IEEE recommendations for traffic types, these may vary or be reassigned.

**Table 6 IEEE Priority to Traffic Type Mapping Recommendations**

PCP	PRIORITY	ACRONYM	TRAFFIC TYPES
1	0 (lowest)	BK	Background
0	1 (default)	BE	Best Effort
2	2	EE	Excellent Effort
3	3	CA	Critical Applications
4	4	VI	Video, <100 ms latency and jitter
5	5	VO	Voice, <10 ms latency and jitter
6	6	IC	Internetwork Control
7	7 (highest)	NC	Network Control

Note: Frames without an explicit priority tag are treated as system traffic and assigned to **Queue0**.

### 6.2.3 Weighted Round Robin Scheduling (WRR)

Round Robin Scheduling services queues on a rotating basis and is activated only when a port has more traffic than it can handle. A queue is a given amount of bandwidth irrespective of the incoming traffic on that port. This queue then moves to the back of the list. The next queue is given an equal amount of bandwidth, and then moves to the end of the list; and so on, depending on the number of queues being used. This works in a looping fashion until a queue is empty.

Weighted Round Robin Scheduling (WRR) uses the same algorithm as round robin scheduling, but services queues based on their priority and queue weight (the number you select in the queue **Weight** field) rather than a fixed amount of bandwidth. WRR is activated only when a port has more traffic than it can handle. The bandwidth is divided across the different traffic queues according to their weights. Queues with larger weights get more service than queues with smaller weights. This queueing mechanism is highly efficient in that it divides any available bandwidth across the different traffic queues and returns to queues that have not yet emptied.

**Figure 11 WRR Application Example**

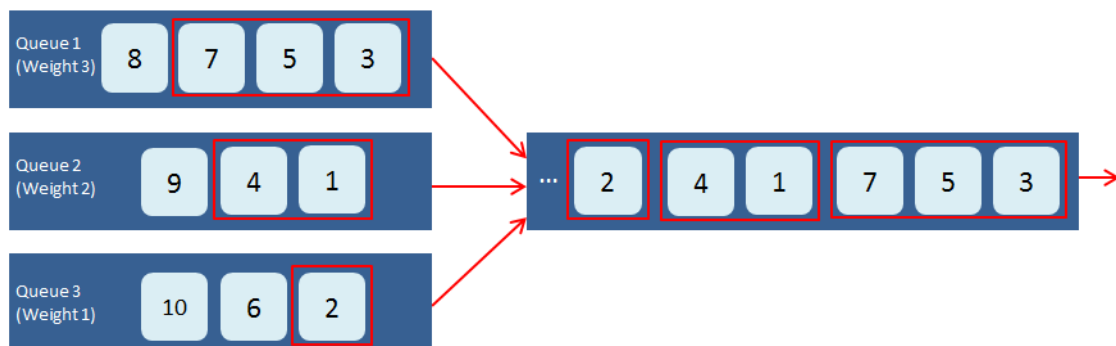

## 6.3 Port-Based QoS Screen

The Switch's default settings for Port-Based QoS are shown in the next figure.

**Figure 12** QoS > Port-Based QoS

Port	1	2	3	4	5	Weight
Queue 0	<input type="radio"/>	<input type="radio"/>	<input type="radio"/>	<input type="radio"/>	<input type="radio"/>	1
Queue 1	<input checked="" type="radio"/>	<input checked="" type="radio"/>	<input checked="" type="radio"/>	<input checked="" type="radio"/>	<input checked="" type="radio"/>	2
Queue 2	<input type="radio"/>	<input type="radio"/>	<input type="radio"/>	<input type="radio"/>	<input type="radio"/>	4
Queue 3	<input type="radio"/>	<input type="radio"/>	<input type="radio"/>	<input type="radio"/>	<input type="radio"/>	8

The Switch allows four priority levels, shown in the table below.

**Table 7** Priority Queuing Levels in QoS

QUEUE NAME	PRIORITY LEVEL
Queue 0	Low Priority
Queue 1	Normal Priority
Queue 2	Medium Priority
Queue 3	High Priority

To apply Port-Based QoS to the Switch, follow these steps:

- 1 Choose which ports will carry the sensitive data, using the priority queuing levels given. Click on each port's radio button to assign a priority queue.
- 2 Assign the weight (the number you select in the queue **Weight** field) to each priority. Remember the weight is based on WRR Scheduling, explained in [Section 11.2.3 on page 16](#). Bandwidth is divided across the different traffic queues according to their weights. Queues with larger weights get more service than queues with smaller weights.
- 3 Click the **Apply** button after you are finished assigning priorities to the ports.

## 6.4 IEEE 802.1P QoS Screen

Both Port-Based QoS and IEEE 802.1P QoS use the same priority queuing levels, shown in [Table 10 on page 17](#). Remember the difference amongst both features relies on how the priority queuing is assigned. Lets recap, Port-Based QoS assigns priority queuing by port, whereas IEEE 802.1P QoS assigns queuing by PCP priority tags.

The Switch's default settings for IEEE 802.1P QoS are shown in the next figure. The numbers from 0 to 7 refer to the priority tags for each traffic type. Refer to [Table 9 on page 16](#).

**Figure 13** QoS > IEEE 802.1P QoS

The screenshot shows the ZYXEL GS1200-5HP v2 web interface. The 'QoS' tab is selected, and 'IEEE 802.1p QoS' is chosen. Below the title 'IEEE 802.1p QoS', there is a table with columns for Priority (0-7) and Weight. The table shows the following configuration:

Priority	0	1	2	3	4	5	6	7	Weight
Queue 0	<input type="radio"/>	<input checked="" type="radio"/>	<input checked="" type="radio"/>	<input type="radio"/>	<input type="radio"/>	<input type="radio"/>	<input type="radio"/>	<input type="radio"/>	1
Queue 1	<input checked="" type="radio"/>	<input type="radio"/>	<input type="radio"/>	<input checked="" type="radio"/>	<input type="radio"/>	<input type="radio"/>	<input type="radio"/>	<input type="radio"/>	2
Queue 2	<input type="radio"/>	<input type="radio"/>	<input type="radio"/>	<input type="radio"/>	<input checked="" type="radio"/>	<input checked="" type="radio"/>	<input type="radio"/>	<input type="radio"/>	4
Queue 3	<input type="radio"/>	<input type="radio"/>	<input type="radio"/>	<input type="radio"/>	<input type="radio"/>	<input type="radio"/>	<input checked="" type="radio"/>	<input checked="" type="radio"/>	8

An 'Apply' button is located at the bottom right of the configuration area.

To apply IEEE 802.1P QoS to the Switch, follow these steps:

- 1 Choose which priority tags will carry the sensitive data, using the priority queuing levels given. Click on each priority tag's radio button to assign a priority queue.
- 2 Assign the weight (the number you select in the queue **Weight** field) to each priority. Remember the weight is based on WRR Scheduling, explained in [Section 11.2.3 on page 16](#). Bandwidth is divided across the different traffic queues according to their weights. Queues with larger weights get more service than queues with smaller weights.
- 3 Click the **Apply** button after you are finished assigning priorities to the priority tags.

# CHAPTER 7

## IGMP Snooping

### 7.1 Overview

This chapter shows you how to configure various multicast features.

Traditionally, IP packets are transmitted in one of either two ways - Unicast (1 sender to 1 recipient) or Broadcast (1 sender to everybody on the network). Multicast delivers IP packets to just a group of hosts on the network.

IGMP (Internet Group Management Protocol) is a network-layer protocol used to establish membership in a multicast group - it is not used to carry user data. Refer to RFC 1112, RFC 2236 and RFC 3376 for information on IGMP versions 1, 2 and 3 respectively.

Note: You must enable IGMP snooping to use the IPTV service.

The following table introduces the IGMP snooping default settings of the Switch.

Table 8 IGMP Snooping Default Settings

	GS1200-5	GS1200-5HP V2	GS1200-8	GS1200-8HP V2
Enable	√ IGMP Static Router Port will be set to Auto.		√ IGMP Static Router Port will be set to Auto.	
Diable		√		√

### IGMP Snooping

The Switch can passively snoop on IGMP packets transferred between IP multicast routers/switches and IP multicast hosts to learn the IP multicast group membership. It checks IGMP packets passing through it, picks out the group registration information, and configures multicasting accordingly. IGMP snooping allows the Switch to learn multicast groups without you having to manually configure them.

The Switch forwards multicast traffic destined for multicast groups (that it has learned from IGMP snooping or that you have manually configured) to ports that are members of that group. IGMP snooping generates no additional network traffic, allowing you to significantly reduce multicast traffic passing through your Switch.

### 7.2 IGMP Snooping Screen

Click **IGMP Snooping** in the navigation panel to display the screen as shown next.

Figure 14 IGMP Snooping

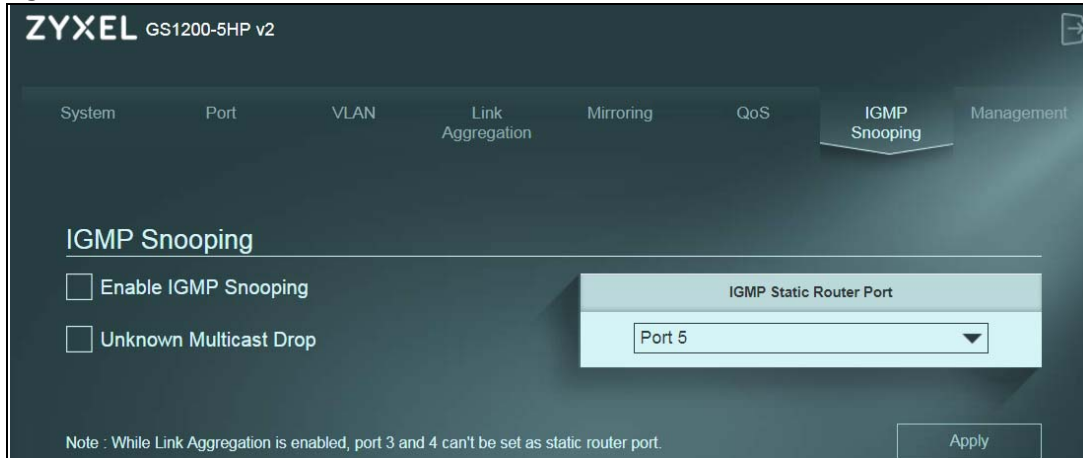

The following table describes the labels in this screen.

Table 9 IGMP Snooping

LABEL	DESCRIPTION
IGMP Snooping	
Enable IGMP Snooping	Select this option to enable IGMP Snooping to forward group multicast traffic only to ports that are members of that group.
Unknown Multicast Drop	Select this option to discard the frame when the Switch receives an unknown multicast frame. Otherwise, the Switch sends the frame to all ports.
IGMP Static Router Port	Select a port to be used as an IGMP query port.  The Switch treats an IGMP query port as being connected to an IGMP multicast router (or server). The Switch forwards IGMP join or leave packets to an IGMP query port.  Note: If link aggregation is enabled, the ports in a link aggregation group won't be available in this field.
Apply	Click <b>Apply</b> to save your changes to the Switch.

# CHAPTER 8

# Management

## 8.1 Overview

This chapter explains how to Use the **Management** screens to configure settings on the Switch, such as login password change, firmware upgrade, system reset or reboot, IP address change, and so on.

### 8.1.1 What You Need to Know

Read this section to know more about IEEE 802.3az Energy Efficient Ethernet (EEE).

#### 8.1.1.1 IEEE 802.3az Energy Efficient Ethernet (EEE)

If EEE is enabled, both sides of a link support EEE and there is no traffic, the port enters Low Power Idle (LPI) mode. LPI mode turns off some functions of the physical layer (becomes quiet) to save power. Periodically the port transmits a REFRESH signal to allow the link partner to keep the link alive. When there is traffic to be sent, a WAKE signal is sent to the link partner to return the link to active mode.

## 8.2 Management Screen

Use this screen to upload the latest firmware, upload a stored device configuration file, save your configurations for later use, change the administrator system password, change the IP address, enable DHCP client, or reboot/reset the system.

An administrator is someone who can both view and configure Switch changes. The default administrator password is **1234**.

Note: It is highly recommended that you change the default administrator password (**1234**).

Click **Management** in the navigation panel to open the following screen.

Figure 15 Switch Management

The following table describes the labels in this screen.

Table 10 Switch Management

LABEL	DESCRIPTION
Device Setting	
Reset	Click this button to clear all Switch configuration information you configured and return to the factory defaults.  If you want to access the Switch web configurator again, you may need to change the IP address of your computer to be in the same subnet as that of the default Switch IP address (192.168.1.3).
Reboot	Click this button to restart the Switch without physically turning the power off.
Firmware Upgrade	Click this button to upgrade the latest firmware to the Switch.
DHCP Client	Select <b>Enable</b> if you have a DHCP server that can assign the Switch an IP address, subnet mask, a default gateway IP address and a domain name server IP address automatically, or select <b>Disable</b> .
IP Address	Enter the IP address of your Switch in dotted decimal notation, for example, 192.168.1.3. This is the IP address of the Switch in an IP routing domain.
Subnet Mask	Enter the IP subnet mask of an IP routing domain in dotted decimal notation, for example, 255.255.255.0.



Table 10 Switch Management (continued)

LABEL	DESCRIPTION
Gateway	Type the IP address of the default outgoing gateway in dotted decimal notation, for example 192.168.1.254.
Apply	Click this button to save your changes to the Switch.
IEEE 802.3az EEE	Select <b>Enable</b> to activate Energy Efficient Ethernet globally, or select <b>Disable</b> .
Apply	Click this button to save your changes to the Switch.
Configuration Restore/Backup	Type the path and file name of the configuration file you wish to restore in the text box or click <b>path</b> to locate it.
Restore	Click <b>Restore</b> to restore a previously saved configuration from your computer to the Switch.  Note: "config" is the name of the configuration file on the Switch, so your backup configuration file is automatically renamed when you restore using this screen.
Backup	Click <b>Backup</b> to save and store your current device settings.
Change Password	
Old Password	Type the existing system password (1234 is the default password when shipped).
New Password	Enter your new system password using keyboard characters (a-z, A-Z, and 0-9). The password must be 4 to 15 characters long
Confirm Password	Retype your new system password for confirmation
Apply	Click this button to save your changes to the Switch.

## 8.2.1 Firmware Upgrade Screen

Firmware upgrades contain bug fixes and fixes for security vulnerabilities. It is recommended to keep the Switch's firmware up to date.

Make sure you have downloaded (and unzipped) the correct model firmware and version to your computer before uploading to the Switch.

**Be sure to upload the correct model firmware as uploading the wrong model firmware may damage your device.**

The following message will appear after you click the **Firmware Upgrade** button. You're not able to configure other settings during the firmware upgrade process to avoid crashes on the Switch. Click **OK**.

Figure 16 Firmware Upgrade Message

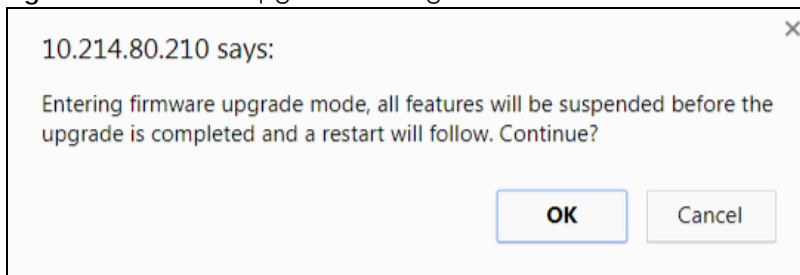

Type the path and file name of the firmware file you wish to upload to the Switch in the text box or click **path** to locate it. After you select the firmware file, click the **Upgrade** button to load the new firmware. After a successful upload, the system will reboot, and you'll need to log into the Switch again.

If you click the **Cancel** button in the **Firmware Upgrade** page, the Switch will reboot, and you'll be direct to the login screen.

**Figure 17** Firmware Upgrade Path

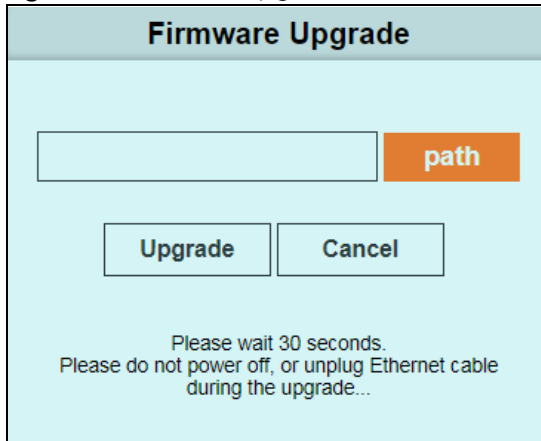

# CHAPTER 1

# Troubleshooting

This chapter offers some suggestions to solve problems you might encounter. The potential problems are divided into the following categories.

- [Power, Hardware Connections, and LEDs](#)
- [Switch Access and Login](#)
- [Switch Configuration](#)

## 1.1 Power, Hardware Connections, and LEDs

---

[The Switch does not turn on. None of the LEDs turn on.](#)

---

- 1 Make sure you are using the power adaptor or cord included with the Switch.
- 2 Make sure the power adaptor or cord is connected to the Switch and plugged in to an appropriate power source. Make sure the power source is turned on.
- 3 Disconnect and re-connect the power adaptor or cord to the Switch.
- 4 If the problem continues, contact the vendor.

---

[One of the LEDs does not behave as expected.](#)

---

- 1 Make sure you understand the normal behavior of the LED. See [Section 3.3 on page 4](#).
- 2 Check the hardware connections. See [Section 14.1 on page 1](#).
- 3 Inspect your cables for damage. Contact the vendor to replace any damaged cables.
- 4 Disconnect and re-connect the power adaptor or cord to the Switch.
- 5 If the problem continues, contact the vendor.

---

[The PoE LED is off and/or power is not being supplied to my PoE-enabled device. \(For GS1200-5HP v2 and GS1200-8HP v2\)](#)

---

- 1 Check to see that the power adaptor is securely connected to the Switch.
- 2 Check to see the Switch is connected to an appropriate power source, and make sure the power source is on and functioning properly.
- 3 Check that the Ethernet cables connection to the devices requiring PoE are connected properly.
- 4 Make sure you are using the correct type of Ethernet cable. See [Section 2.2 on page 1](#) for more information about the types of Ethernet cable supported. Contact your local distributor if the problem persists.
- 5 Click **System** in the navigation panel and check if the total power requested by the PoE-enabled devices exceed the total PoE power budget on the Switch. If it does, reconnect the PoE-enabled devices in the order that you want the Switch to allocate power to.  
See [Section 5.1.3 on page 9](#) for the information about the maximum power the Switch and a PoE port can supply.

---

### A loop is detected.

---

See [Section 7.1.1.3 on page 5](#) for more information about PoE.

- 1 To restore a port in a loop state, disconnect it, check the network connections, and reconnect it.
- 2 You can log into the Web Configurator. Go to **System** in the Web Configurator to check your port status. Note that you can do this when you enable **Loop Prevention** (default) in the **Port** screen. If **Loop Detection** is enabled, you can't log into the Switch.

## 1.2 Switch Access and Login

---

### I forgot the IP address for the Switch.

---

- 1 The default IP address is **192.168.1.3**.
- 2 If this does not work, you have to reset the device to its factory defaults. See [Section 4.5 on page 5](#).

---

### I forgot the password.

---

- 1 The default password is **1234**.
- 2 If this does not work, you have to reset the device to its factory defaults. See [Section 4.5 on page 5](#).

---

I cannot see or access the **Login** screen in the web configurator.

---

- 1 Make sure you are using the correct IP address.
  - The default IP address is [192.168.1.3](#).
  - If you changed the IP address, use the new IP address.
  - If you changed the IP address and have forgotten it, see the troubleshooting suggestions for [I forgot the IP address for the Switch](#).
- 2 Check the hardware connections, and make sure the LEDs are behaving as expected. See [Section 3.3 on page 4](#).
- 3 Make sure your Internet browser does not block pop-up windows and has JavaScripts and Java enabled.
- 4 Make sure your computer is in the same subnet as the Switch. (If you know that there are routers between your computer and the Switch, skip this step.)
- 5 Reset the device to its factory defaults, and try to access the Switch with the default IP address. See [Section 4.5 on page 5](#).
- 6 If the problem continues, contact the vendor, or try one of the advanced suggestions.

---

I can see the **Login** screen, but I cannot log in to the Switch.

---

- 1 Make sure you have entered the password correctly. The default password is **1234**.
- 2 Disconnect and re-connect the cord to the Switch.
- 3 If this does not work, you have to reset the device to its factory defaults. See [Section 4.5 on page 5](#).

---

[Pop-up Windows, JavaScripts and Java Permissions](#)

---

In order to use the web configurator you need to allow:

- Web browser pop-up windows from your device.
- JavaScripts (enabled by default).
- Java permissions (enabled by default).

## 1.3 Switch Configuration

---

After upgrading firmware on the Switch, the login screen doesn't display.

---

You will see the **Firmware Upgrade** screen, when one of the following situations happens. These will lead to a failure at upgrading firmware.

During the firmware upgrade process:

- The Switch loses power.
- The computer from which you uploaded the firmware file to the Switch is turned off.
- The Ethernet cable connecting the Switch and the computer comes loose. It's the computer from which you uploaded the firmware file to the Switch.

When one of the situations above happens, and you're directed to the **Firmware Upgrade** screen, follow the steps below:

- 1 Make sure the power supply is sufficient in your environment.
- 2 Make sure your computer's Ethernet cable is securely connected to the Switch.
- 3 Select the firmware file that you tried to upload to the Switch before you upgrade firmware again in the **Firmware Upgrade** screen.
- 4 Wait for the firmware upgrade process to complete. After a successful upload, the system will reboot, and you'll need to log into the Switch again.

# APPENDIX A

## Customer Support

In the event of problems that cannot be solved by using this manual, you should contact your vendor. If you cannot contact your vendor, then contact a Zyxel office for the region in which you bought the device.

See <http://www.zyxel.com/homepage.shtml> and also [http://www.zyxel.com/about\\_zyxel/zyxel\\_worldwide.shtml](http://www.zyxel.com/about_zyxel/zyxel_worldwide.shtml) for the latest information.

Please have the following information ready when you contact an office.

### Required Information

- Product model and serial number.
- Warranty Information.
- Date that you received your device.
- Brief description of the problem and the steps you took to solve it.

### Corporate Headquarters (Worldwide)

#### Taiwan

- Zyxel Communications Corporation
- <http://www.zyxel.com>

### Asia

#### China

- Zyxel Communications (Shanghai) Corp.
- Zyxel Communications (Beijing) Corp.
- Zyxel Communications (Tianjin) Corp.
- <http://www.zyxel.cn>

#### India

- Zyxel Technology India Pvt Ltd
- <http://www.zyxel.in>

#### Kazakhstan

- Zyxel Kazakhstan
- <http://www.zyxel.kz>

## **Korea**

- Zyxel Korea Corp.
- <http://www.zyxel.kr>

## **Malaysia**

- Zyxel Malaysia Sdn Bhd.
- <http://www.zyxel.com.my>

## **Pakistan**

- Zyxel Pakistan (Pvt.) Ltd.
- <http://www.zyxel.com.pk>

## **Philippines**

- Zyxel Philippines
- <http://www.zyxel.com.ph>

## **Singapore**

- Zyxel Singapore Pte Ltd.
- <http://www.zyxel.com.sg>

## **Taiwan**

- Zyxel Communications Corporation
- <http://www.zyxel.com/tw/zh/>

## **Thailand**

- Zyxel Thailand Co., Ltd
- <http://www.zyxel.co.th>

## **Vietnam**

- Zyxel Communications Corporation-Vietnam Office
- <http://www.zyxel.com/vn/vi>

## **Europe**

### **Austria**

- Zyxel Deutschland GmbH
- <http://www.zyxel.de>

### **Belarus**

- Zyxel BY
- <http://www.zyxel.by>



## **Belgium**

- Zyxel Communications B.V.
- <http://www.zyxel.com/be/nl/>
- <http://www.zyxel.com/be/fr/>

## **Bulgaria**

- Zyxel България
- <http://www.zyxel.com/bg/bg/>

## **Czech Republic**

- Zyxel Communications Czech s.r.o
- <http://www.zyxel.cz>

## **Denmark**

- Zyxel Communications A/S
- <http://www.zyxel.dk>

## **Estonia**

- Zyxel Estonia
- <http://www.zyxel.com/ee/et/>

## **Finland**

- Zyxel Communications
- <http://www.zyxel.fi>

## **France**

- Zyxel France
- <http://www.zyxel.fr>

## **Germany**

- Zyxel Deutschland GmbH
- <http://www.zyxel.de>

## **Hungary**

- Zyxel Hungary & SEE
- <http://www.zyxel.hu>

## **Italy**

- Zyxel Communications Italy
- <http://www.zyxel.it/>

## **Latvia**

- Zyxel Latvia
- <http://www.zyxel.com/lv/lv/homepage.shtml>

## **Lithuania**

- Zyxel Lithuania
- <http://www.zyxel.com/lt/lt/homepage.shtml>

## **Netherlands**

- Zyxel Benelux
- <http://www.zyxel.nl>

## **Norway**

- Zyxel Communications
- <http://www.zyxel.no>

## **Poland**

- Zyxel Communications Poland
- <http://www.zyxel.pl>

## **Romania**

- Zyxel Romania
- <http://www.zyxel.com/ro/ro>

## **Russia**

- Zyxel Russia
- <http://www.zyxel.ru>

## **Slovakia**

- Zyxel Communications Czech s.r.o. organizacna zlozka
- <http://www.zyxel.sk>

## **Spain**

- Zyxel Communications ES Ltd
- <http://www.zyxel.es>

## **Sweden**

- Zyxel Communications
- <http://www.zyxel.se>

## **Switzerland**

- Studerus AG

- <http://www.zyxel.ch/>

### **Turkey**

- Zyxel Turkey A.S.
- <http://www.zyxel.com.tr>

### **UK**

- Zyxel Communications UK Ltd.
- <http://www.zyxel.co.uk>

### **Ukraine**

- Zyxel Ukraine
- <http://www.ua.zyxel.com>

## **Latin America**

### **Argentina**

- Zyxel Communication Corporation
- <http://www.zyxel.com/ec/es/>

### **Brazil**

- Zyxel Communications Brasil Ltda.
- <https://www.zyxel.com/br/pt/>

### **Ecuador**

- Zyxel Communication Corporation
- <http://www.zyxel.com/ec/es/>

## **Middle East**

### **Israel**

- Zyxel Communication Corporation
- <http://il.zyxel.com/homepage.shtml>

### **Middle East**

- Zyxel Communication Corporation
- <http://www.zyxel.com/me/en/>

## North America

### USA

- Zyxel Communications, Inc. - North America Headquarters
- <http://www.zyxel.com/us/en/>

## Oceania

### Australia

- Zyxel Communications Corporation
- <http://www.zyxel.com/au/en/>

## Africa

### South Africa

- Nology (Pty) Ltd.
- <http://www.zyxel.co.za>

# APPENDIX A

## Legal Information

### Copyright

Copyright © 2017 by Zyxel Communications Corporation.

The contents of this publication may not be reproduced in any part or as a whole, transcribed, stored in a retrieval system, translated into any language, or transmitted in any form or by any means, electronic, mechanical, magnetic, optical, chemical, photocopying, manual, or otherwise, without the prior written permission of Zyxel Communications Corporation.

Published by Zyxel Communications Corporation. All rights reserved.

### Disclaimer

Zyxel does not assume any liability arising out of the application or use of any products, or software described herein. Neither does it convey any license under its patent rights nor the patent rights of others. Zyxel further reserves the right to make changes in any products described herein without notice. This publication is subject to change without notice.

### Regulatory Notice and Statement

#### UNITED STATES of AMERICA



The following information applies if you use the product within USA area.

#### FCC EMC Statement

- The device complies with Part 15 of FCC rules. Operation is subject to the following two conditions:
  - (1) This device may not cause harmful interference, and
  - (2) This device must accept any interference received, including interference that may cause undesired operation.
- Changes or modifications not expressly approved by the party responsible for compliance could void the user's authority to operate the device.
- This product has been tested and complies with the specifications for a Class B digital device, pursuant to Part 15 of the FCC Rules. These limits are designed to provide reasonable protection against harmful interference in a residential installation. This device generates, uses, and can radiate radio frequency energy and, if not installed and used according to the instructions, may cause harmful interference to radio communications. However, there is no guarantee that interference will not occur in a particular installation.
- If this device does cause harmful interference to radio or television reception, which is found by turning the device off and on, the user is encouraged to try to correct the interference by one or more of the following measures:
  - Reorient or relocate the receiving antenna
  - Increase the separation between the devices
  - Connect the equipment to an outlet other than the receiver's
  - Consult a dealer or an experienced radio/TV technician for assistance

#### CANADA

The following information applies if you use the product within Canada area

#### Industry Canada ICES statement

CAN ICES-3 (B)/NMB-3(B)

#### EUROPEAN UNION



The following information applies if you use the product within the European Union.

List of national codes

COUNTRY	ISO 3166 2 LETTER CODE	COUNTRY	ISO 3166 2 LETTER CODE
Austria	AT	Liechtenstein	LI
Belgium	BE	Lithuania	LT
Bulgaria	BG	Luxembourg	LU
Croatia	HR	Malta	MT
Cyprus	CY	Netherlands	NL
Czech Republic	CZ	Norway	NO
Denmark	DK	Poland	PL
Estonia	EE	Portugal	PT
Finland	FI	Romania	RO
France	FR	Serbia	RS
Germany	DE	Slovakia	SK
Greece	GR	Slovenia	SI
Hungary	HU	Spain	ES
Iceland	IS	Switzerland	CH
Ireland	IE	Sweden	SE
Italy	IT	Turkey	TR
Latvia	LV	United Kingdom	GB

Safety Warnings

- Do not use this product near water, for example, in a wet basement or near a swimming pool.
- Do not expose your device to dampness, dust or corrosive liquids.
- Do not store things on the device.
- Do not obstruct the device ventilation slots as insufficient airflow may harm your device. For example, do not place the device in an enclosed space such as a box or on a very soft surface such as a bed or sofa.
- Do not install, use, or service this device during a thunderstorm. There is a remote risk of electric shock from lightning.
- Connect ONLY suitable accessories to the device.
- Do not open the device or unit. Opening or removing covers can expose you to dangerous high voltage points or other risks.
- Only qualified service personnel should service or disassemble this device. Please contact your vendor for further information.
- Make sure to connect the cables to the correct ports.
- Place connecting cables carefully so that no one will step on them or stumble over them.
- Always disconnect all cables from this device before servicing or disassembling.
- Do not remove the plug and connect it to a power outlet by itself; always attach the plug to the power adaptor first before connecting it to a power outlet.
- Do not allow anything to rest on the power adaptor or cord and do NOT place the product where anyone can walk on the power adaptor or cord.
- Please use the provided or designated connection cables/power cables/ adaptors. Connect it to the right supply voltage (for example, 110V AC in North America or 230V AC in Europe). If the power adaptor or cord is damaged, it might cause electrocution. Remove it from the device and the power source, repairing the power adapter or cord is prohibited. Contact your local vendor to order a new one.
- Do not use the device outside, and make sure all the connections are indoors. There is a remote risk of electric shock from lightning.
- CAUTION: Risk of explosion if battery is replaced by an incorrect type, dispose of used batteries according to the instruction. Dispose them at the applicable collection point for the recycling of electrical and electronic devices. For detailed information about recycling of this product, please contact your local city office, your household waste disposal service or the store where you purchased the product.
- The POE (Power over Ethernet) devices that supply or receive power and their connected Ethernet cables must all be completely indoors.
- The following warning statements apply, where the disconnect device is not incorporated in the device or where the plug on the power supply cord is intended to serve as the disconnect device.
  - For permanently connected devices, a readily accessible disconnect device shall be incorporated external to the device;
  - For pluggable devices, the socket-outlet shall be installed near the device and shall be easily accessible.

Environment Statement

ErP (Energy-related Products)

Zyxel products put on the EU market in compliance with the requirement of the European Parliament and the Council published Directive 2009/125/EC establishing a framework for the setting of ecodesign requirements for energy-related products (recast), so called as "ErP Directive (Energy-related Products directive)" as well as ecodesign requirement laid down in applicable implementing measures, power consumption has satisfied regulation requirements which are:

- Network standby power consumption < 8W, and/or
- Off mode power consumption < 0.5W, and/or
- Standby mode power consumption < 0.5W.

(Wireless setting, please refer to "Wireless" chapter for more detail.)

## European Union - Disposal and Recycling Information

The symbol below means that according to local regulations your product and/or its battery shall be disposed of separately from domestic waste. If this product is end of life, take it to a recycling station designated by local authorities. At the time of disposal, the separate collection of your product and/or its battery will help save natural resources and ensure that the environment is sustainable development.

Die folgende Symbol bedeutet, dass Ihr Produkt und/oder seine Batterie gemäß den örtlichen Bestimmungen getrennt vom Hausmüll entsorgt werden muss. Wenden Sie sich an eine Recyclingstation, wenn dieses Produkt das Ende seiner Lebensdauer erreicht hat. Zum Zeitpunkt der Entsorgung wird die getrennte Sammlung von Produkt und/oder seiner Batterie dazu beitragen, natürliche Ressourcen zu sparen und die Umwelt und die menschliche Gesundheit zu schützen.

El símbolo de abajo indica que según las regulaciones locales, su producto y/o su batería deberán depositarse como basura separada de la doméstica. Cuando este producto alcance el final de su vida útil, llévelo a un punto limpio. Cuando llegue el momento de desechar el producto, la recogida por separado éste y/o su batería ayudará a salvar los recursos naturales y a proteger la salud humana y medioambiental.

Le symbole ci-dessous signifie que selon les réglementations locales votre produit et/ou sa batterie doivent être éliminés séparément des ordures ménagères. Lorsque ce produit atteint sa fin de vie, amenez-le à un centre de recyclage. Au moment de la mise au rebut, la collecte séparée de votre produit et/ou de sa batterie aidera à économiser les ressources naturelles et protéger l'environnement et la santé humaine.

Il simbolo sotto significa che secondo i regolamenti locali il vostro prodotto e/o batteria deve essere smaltito separatamente dai rifiuti domestici. Quando questo prodotto raggiunge la fine della vita di servizio portarlo a una stazione di riciclaggio. Al momento dello smaltimento, la raccolta separata del vostro prodotto e/o della sua batteria aiuta a risparmiare risorse naturali e a proteggere l'ambiente e la salute umana.

Symbolen innebär att enligt lokal lagstiftning ska produkten och/eller dess batteri kastas separat från hushållsavfallet. När den här produkten når slutet av sin livslängd ska du ta den till en återvinningsstation. Vid tiden för kasseringen bidrar du till en bättre miljö och mänsklig hälsa genom att göra dig av med den på ett återvinningsställe.



## 台灣





安全警告 - 為了您的安全，請先閱讀以下警告及指示：

- 請勿將此產品接近水、火焰或放置在高溫的環境。
- 避免設備接觸
  - 任何液體 - 切勿讓設備接觸水、雨水、高濕度、污水腐蝕性的液體或其他水份。
  - 灰塵及污物 - 切勿接觸灰塵、污物、沙土、食物或其他不適合的材料。
- 雷雨天氣時，不要安裝，使用或維修此設備。有遭受電擊的風險。
- 切勿重摔或撞擊設備，並勿使用不正確的電源變壓器。
- 若接上不正確的電源變壓器會有爆炸的風險。
- 請勿隨意更換產品內的電池。
- 如果更換不正確的電池型式，會有爆炸的風險，請依製造商說明書處理使用過之電池。
- 請將廢電池丟棄在適當的電器或電子設備回收處。
- 請勿將設備解體。
- 請勿阻礙設備的散熱孔，空氣對流不足將會造成設備損害。
- 請插在正確的電壓供給插座（如：北美 / 台灣電壓 110V AC，歐洲是 230V AC）。
- 假若電源變壓器或電源變壓器的纜線損壞，請從插座拔除，若您還繼續插電使用，會有觸電死亡的風險。
- 請勿試圖修理電源變壓器或電源變壓器的纜線，若有毀損，請直接聯絡您購買的店家，購買一個新的電源變壓器。
- 請勿將此設備安裝於室外，此設備僅適合放置於室內。
- 請勿隨一般垃圾丟棄。
- 請參閱產品背貼上的設備額定功率。
- 請參考產品型錄或是彩盒上的作業溫度。
- 產品沒有斷電裝置或者採用電源線的插頭視為斷電裝置的一部分，以下警語將適用：
  - 對永久連接之設備，在設備外部須安裝可觸及之斷電裝置；
  - 對插接式之設備，插座必須接近安裝之地點而且是易於觸及的。

## About the Symbols

Various symbols are used in this product to ensure correct usage, to prevent danger to the user and others, and to prevent property damage. The meaning of these symbols are described below. It is important that you read these descriptions thoroughly and fully understand the contents.

### Explanation of the Symbols

SYMBOL	EXPLANATION
	Alternating current (AC): AC is an electric current in which the flow of electric charge periodically reverses direction.
	Direct current (DC): DC is the unidirectional flow or movement of electric charge carriers.
	Earth; ground: A wiring terminal intended for connection of a Protective Earthing Conductor.
	Class II equipment: The method of protection against electric shock in the case of class II equipment is either double insulation or reinforced insulation.

### Viewing Certifications

Go to <http://www.zyxel.com> to view this product's documentation and certifications.

### Zyxel Limited Warranty

Zyxel warrants to the original end user (purchaser) that this product is free from any defects in material or workmanship for a specific period (the Warranty Period) from the date of purchase. The Warranty Period varies by region. Check with your vendor and/or the authorized Zyxel local distributor for details about the Warranty Period of this product. During the warranty period, and upon proof of purchase, should the product have indications of failure due to faulty workmanship and/or materials, Zyxel will, at its discretion, repair or replace the defective products or components without charge for either parts or labor, and to whatever extent it shall deem necessary to restore the product or components to proper operating condition. Any replacement will consist of a new or re-manufactured functionally equivalent product of equal or higher value, and will be solely at the discretion of Zyxel. This warranty shall not apply if the product has been modified, misused, tampered with, damaged by an act of God, or subjected to abnormal working conditions.

#### Note

Repair or replacement, as provided under this warranty, is the exclusive remedy of the purchaser. This warranty is in lieu of all other warranties, express or implied, including any implied warranty of merchantability or fitness for a particular use or purpose. Zyxel shall in no event be held liable for indirect or consequential damages of any kind to the purchaser.

To obtain the services of this warranty, contact your vendor. You may also refer to the warranty policy for the region in which you bought the device at [http://www.zyxel.com/web/support\\_warranty\\_info.php](http://www.zyxel.com/web/support_warranty_info.php).

### Registration

Register your product online to receive e-mail notices of firmware upgrades and information at [www.zyxel.com](http://www.zyxel.com) for global products, or at [www.us.zyxel.com](http://www.us.zyxel.com) for North American products.

### Trademarks

ZyNOS (Zyxel Network Operating System) and ZON (Zyxel One Network) are registered trademarks of Zyxel Communications, Inc. Other trademarks mentioned in this publication are used for identification purposes only and may be properties of their respective owners.

### Open Source Licenses

This product contains in part some free software distributed under GPL license terms and/or GPL like licenses. Open source licenses are provided with the firmware package. You can download the latest firmware at [www.zyxel.com](http://www.zyxel.com). To obtain the source code covered under those Licenses, please contact [support@zyxel.com.tw](mailto:support@zyxel.com.tw) to get it.



# Index

## A

airflow [3](#)  
applications  
    backbone [2](#)

## C

certifications [2](#)  
    viewing [4](#)  
CFI [8](#)  
CFI (Canonical Format Indicator) [8](#)  
changing the password [4](#)  
contact information [1](#)  
copyright [1](#)  
customer support [1](#)

## D

default IP [1](#)  
disclaimer [1](#)

## F

front panel [2](#)

## H

hardware installation [1](#)  
hardware overview [2](#)

## I

IGMP snooping [19](#)  
initial setup [6](#)  
installation  
    desktop [1](#)  
installation scenarios [1](#)

## L

LEDs [4](#)  
login [1](#)  
    password [4](#)  
login account  
    Administrator [21](#)

## M

managing the device  
    good habits [3](#)

## N

network applications [2](#)

## P

password [4](#)  
port VLAN ID, see PVID [9](#)  
power connector [3](#)  
product registration [4](#)  
PVID [8](#)

## R

- rear panel connections [3](#)
- registration
  - product [4](#)
- resetting [5](#)
- restoring configuration [5](#)

## S

- status [2](#)
- switch reset [5](#)

## T

- tagged VLAN [8](#)
- trademarks [4](#)

## V

- VID [10](#)
  - number of possible VIDs [8](#)
  - priority frame [8](#)
- VID (VLAN Identifier) [8](#)
- VLAN
  - ID [8](#)
  - introduction [8](#)
  - PVID [9](#)
  - tagged [8](#)
- VLAN ID [8, 10](#)

## W

- warranty [4](#)
  - note [4](#)
- web configurator
  - home [2](#)
  - login [1](#)
  - logout [5](#)