

Help Guide

- ✓ **Windows Scanner User's Guide, P2-P34**
- ✓ **DocTWAIN Online Help, P35-P74**
- ✓ **DocAction Online Help, P75-P133**
- ✓ **Scanner Utility Help, P134-P142**
- ✓ **Mac Scanner User's Guide, P143-P171**
- ✓ **MacAction Online Help, P172-P222**

Driver Download:

<https://plustek.com/us/products/flatbed-scanners/opticpro-a320e/support.php>

Please contact us directly if you have questions

Tel: (714) 670-7713, Mon-Fri 9:00AM~5:30PM, PST

Email: infoUSA@plustekus.com

Or fill out the technical support form at

<https://plustek.com/us/support/technical-support-form.php>



Scanner User's Guide

OpticPro

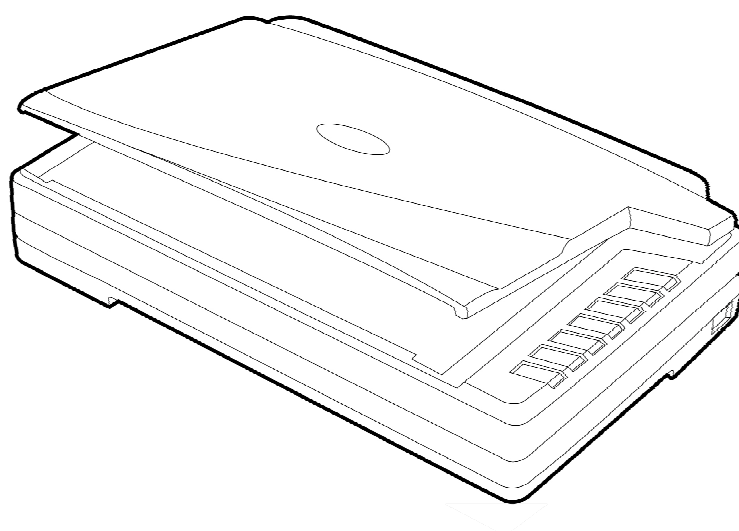

Trademarks

© 2021 Plustek Inc. All rights are reserved. No portion of this document may be reproduced without permission.

Plustek is a registered trademark of Plustek Inc. OCR processing by ABBYY® FineReader®, © 2021 ABBYY. ABBYY and FineReader are trademarks of ABBYY Software, Ltd. which may be registered in some jurisdictions.

All trademarks and brand names mentioned in this publication are property of their respective owners.

Liability

While all efforts have been made to ensure the accuracy of all contents in this manual, we assume no liability for errors or omissions or by statements of any kind in this manual, whether such errors are omissions or statements resulting from negligence, accidents, or any other cause. The contents of this manual are subject to change without notice. We will not shoulder any legal liability, if users failed to follow the operation instructions in this manual.

Copyright

The scanning of certain documents, for example checks, bank notes, I.D. cards, government bonds, or public documents, may be prohibited by law and/or subject to criminal prosecution. We recommend you to be responsible and respectful of the copyrights laws when you are scanning books, magazines, journals and other materials.

Environmental Information

Recycle or disposal at end-of-life information, please ask local distributors or suppliers for recycle and disposal information. The product is designed and produced to achieve sustainable environmental improvement. We strive to produce products in compliance with global environmental standards. Please consult your local authorities for proper disposal.

The product packaging is recyclable.

Attention for recycling (For EU country only)

Protect your environment! This product should not be thrown into the household waste container. Please give it to the free collecting center in your community.

Screen Examples in This Manual

The screen shots in this guide were made with Windows 7. If you are using Windows 8 / 10, your screen will look somewhat different but functions the same.

Table of Contents

| | |
|--|-----------|
| INTRODUCTION | 1 |
| How to Use This Guide..... | 1 |
| Conventions of This Guide | 2 |
| <i>A Note about Icons</i> | 2 |
| Safety Precautions..... | 2 |
| Minimum System Requirements..... | 3 |
| Box Contents | 4 |
| Scanner Overview | 5 |
| CHAPTER I. INSTALLING THE SCANNER | 7 |
| Software Installation Requirements | 7 |
| Hardware Requirements..... | 7 |
| Installing and Setting up the Scanner | 8 |
| <i>Step 1. Unlock Your Scanner</i> | 8 |
| <i>Step 2. Connecting the Scanner to Your Computer</i> | 9 |
| <i>Step 3. Installing the Software</i> | 10 |
| <i>Step 4. Testing the Scanner</i> | 11 |
| Installing Additional Software..... | 12 |
| CHAPTER II. SCANNING | 13 |
| Preparing Documents | 13 |
| <i>Checking Document Conditions</i> | 13 |
| Placing Documents..... | 14 |
| <i>Using the Flatbed</i> | 14 |
| Scanning Documents..... | 14 |
| <i>Scanning via TWAIN Interface</i> | 15 |
| <i>Scanning from the Scanner's Panel or On-screen DocAction's Execute Menu</i> | 16 |
| <i>Scanning from the Icon in the Left Side of the DocAction Window</i> | 19 |
| CHAPTER III. CARE AND MAINTENANCE | 21 |
| Cleaning the Scanner | 21 |
| <i>Cleaning Materials</i> | 21 |
| <i>Cleaning the Flatbed</i> | 21 |
| Aligning the Scanner..... | 22 |
| Standby Mode..... | 23 |
| Scanner Lock..... | 24 |
| CHAPTER IV. TROUBLESHOOTING | 25 |
| Scanner Connection | 25 |
| APPENDIX A: SPECIFICATIONS | 26 |
| APPENDIX B: CUSTOMER SERVICE AND WARRANTY | 27 |
| Service & Support Information (For EU country only)..... | 27 |
| Statement of Limited Warranty | 28 |
| FCC Radio Frequency Statement..... | 29 |

INTRODUCTION

Thank you for choosing us as your scanner supplier. Your new scanner will improve the professionalism of your day-to-day computing tasks by allowing you to input images and electronic text into your computer system.

Like all of our products, your new scanner is thoroughly tested and backed by our reputation for unsurpassed dependability and customer satisfaction. We hope you will continue to turn to us for additional quality products as your computing needs and interests grow.

HOW TO USE THIS GUIDE

This User's Guide provides instructions and illustrations on how to install and operate your scanner. This guide assumes the user is familiar with Microsoft Windows. If this is not the case, we suggest you learn more about Microsoft Windows by referring to your Microsoft Windows manual before using your scanner.

The Introduction section of this manual describes the box contents and minimum computer requirements to use this scanner. Before you start installing your scanner, check the box contents to make sure all parts are included. If any items are damaged or missing, please contact the vendor where you purchased your scanner or our customer service directly.

Chapter I describes how to install the scanner's software and connect the scanner to your computer. Note: The scanner connects to your computer through the Universal Serial Bus (USB). If your computer does not support USB technology, you will need to purchase a USB interface card to add USB capabilities to your computer, or buy and install USB connectors if your motherboard has USB capabilities. This guide assumes that your computer is USB-ready and has a free USB port.

Chapter II describes how to use your scanner.

Chapter III describes how to maintain and clean your scanner.

Chapter IV contains technical support information that can help you solve simple problems.

Appendix A contains the specifications of the scanner you purchased.

Appendix B contains our customer service, the limited warranty agreement and FCC statement concerning the product.

CONVENTIONS OF THIS GUIDE

Bold —Represents commands or contents on your computer screen.

ALL CAPS —Important note or first use of an important term in a chapter.

Italic —Represents buttons on your scanner OR important notes.

A Note about Icons

This guide uses the following icons to point out information that deserves special attention.



Warning

A procedure that must be followed carefully to prevent injury, or accidents.



Attention

Instructions that are important to remember and may prevent mistakes.



Information

Optional tips for your reference.

SAFETY PRECAUTIONS



Warning

Before using this device, please read the following important information to eliminate or reduce any possibility of causing damage and personal injury.

1. Usage, the product is for indoor use in dry locations. Moisture condensation may occur inside this device and cause malfunction at these conditions:
 - when this device is moved directly from a cold to a warm location;
 - after a cold room is heated;
 - when this device is placed in a damp room.To avoid the moisture condensation, you are recommended to follow the procedure:
 - i. Seal this device in a plastic bag for it to adapt to room conditions.
 - ii. Wait for 1-2 hours before removing this device from the bag.
2. Do use the AC adapter, power cable and USB cable provided with the scanner. Use of other AC adapter and cables may lead to malfunction.
3. Keep the space around the AC adapter and power cable clear in case you need to quickly unplug the AC adapter during emergencies.

4. Damaged wire could cause fire or electrical shock. Keep the power cord straight and without being twisted, bended, or scraped.
5. Unplug this device if you don't need to use it for a certain period of time, such as, during night or long weekend, to avoid any risks of causing fire.
6. Do not attempt to disassemble the scanner. There is danger of an electrical shock and opening your scanner will void your warranty.
7. Be sure not to bump or knock the scanner glass as it is fragile and could break.
8. Do not subject the scanner to excessive vibration. It may damage the internal components.

MINIMUM SYSTEM REQUIREMENTS¹

- PC with Intel Core i5 processor or higher
- 4 GB RAM or higher (For maximum A3 size@1600 dpi scanning, allocated 20 GB Virtual Memory at least.)
- Available USB 2.0 port
- DVD-ROM Drive
- 800 MB Free Hard Disk Space
- Video card that supports 16-bit color or greater
- Operating System: Windows 7 / 8 / 10

¹ Higher requirements might be needed when scanning or editing a large quantity of image data. The system requirements here are only a guideline, as in general the better the computer (motherboard, processor, hard disk, RAM, video graphic card), the better the results.

BOX CONTENTS²

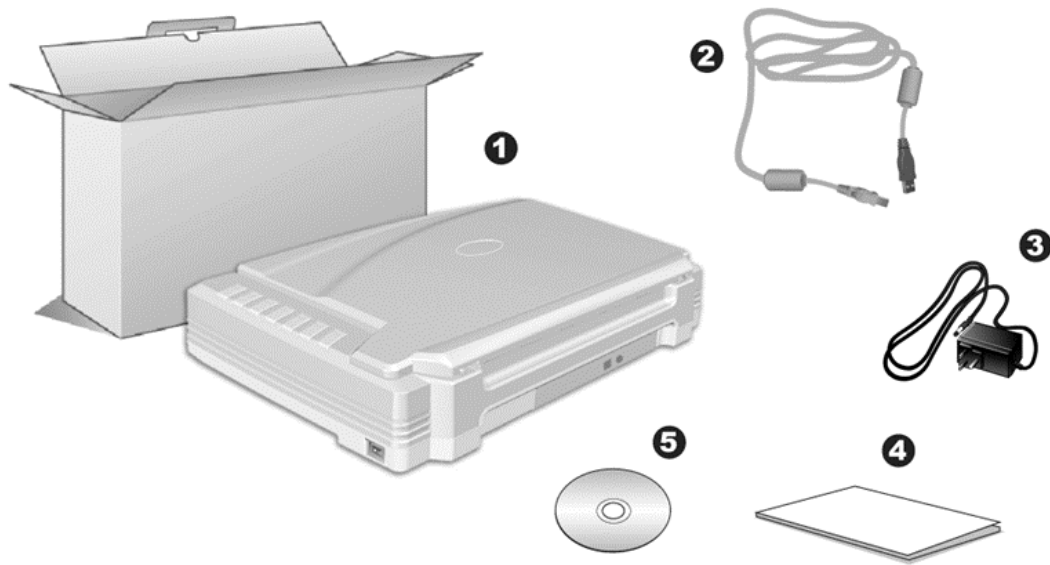

1. Scanner³
2. USB Cable
3. AC Adapter
4. Quick Guide
5. Setup/Application DVD-ROM

² Save the box and packing materials in case you need to transport this scanner in the future.

³ The scanner illustration(s) in this manual may appear different than from the actual scanner itself.

SCANNER OVERVIEW

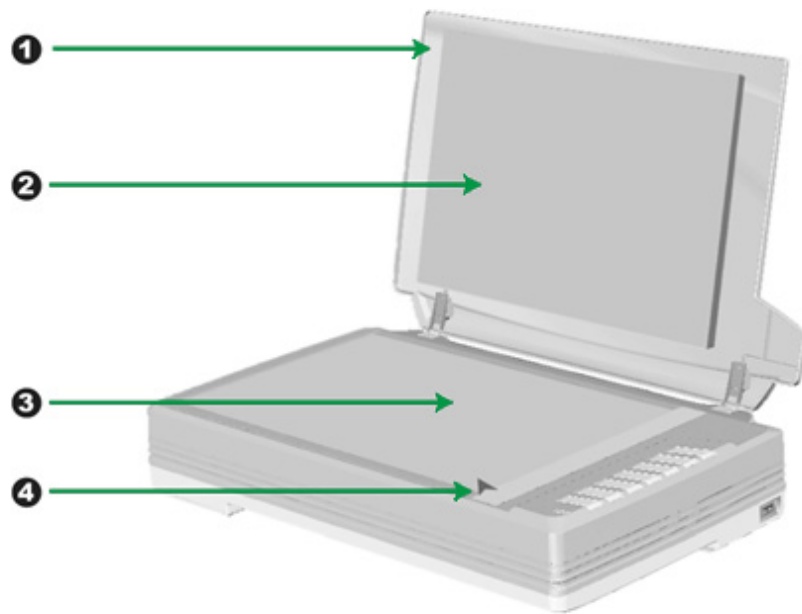

1. DOCUMENT COVER— Helps keep the paper in place and protects the scanner glass.
2. DOCUMENT PAD— Keeps the paper in place and improves accuracy of image quality.
3. SCANNER GLASS— Where you put items for flatbed scanning.
4. REFERENCE MARK— Align your paper with this reference mark for flatbed scanning.

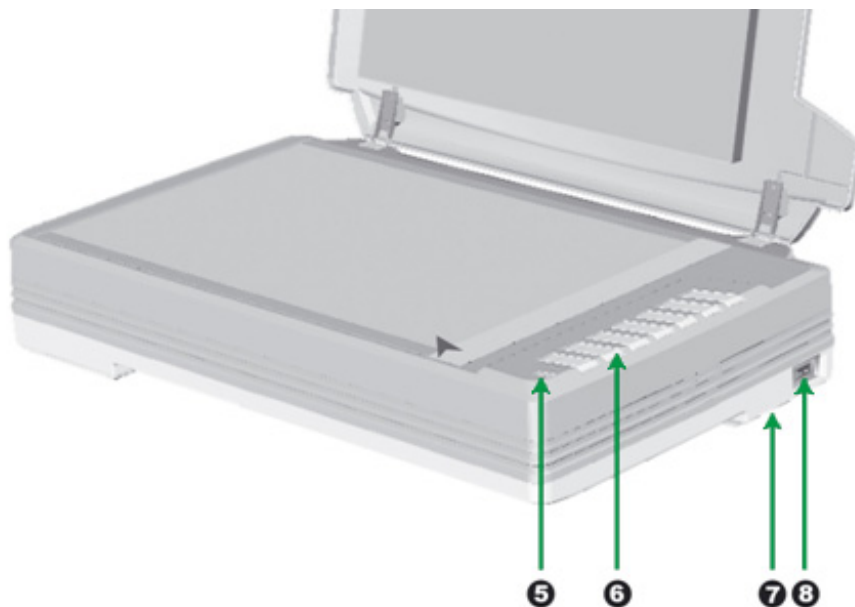

5. **POWER LED**— Indicates the scanner status.

| Light | Status |
|--------|---|
| Green | The scanner is turned on, ready to scan images. |
| Orange | The scanner is in standby mode if it is idle for 10 minutes. |
| Off | The scanner is off, either because the power is not turned on, or because the power cord is not properly plugged into an AC power outlet. |

6. **SCANNER BUTTONS**—You may press any button to perform a predefined scanning task.

7. **SCANNER LOCK** (located on the scanner's underside)— Holds your scanner head in place during transportation.

8. **POWER SWITCH**— Use this to turn the scanner ON or OFF.

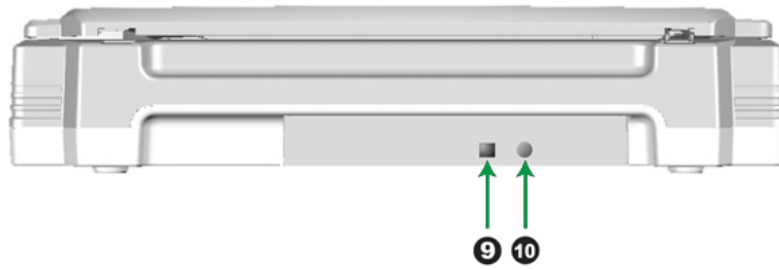

9. **USB PORT**— Connects the scanner to a USB port on your computer by the USB cable included.

10. **POWER RECEPTOR**— Connects the scanner to a standard AC power outlet by the AC adapter included.

CHAPTER I. INSTALLING THE SCANNER

Before installing your scanner, please verify that you have all of the proper components. A list of the package contents is provided in the “Box Contents” section of this guide.

SOFTWARE INSTALLATION REQUIREMENTS

Your scanner comes with the scanner’s driver and the task management software (Plustek DocAction). All of these software applications use approximately 400 megabytes of hard disk space after they are installed into your computer. To ensure ample room for the installation, as well as for scanning and saving images, a minimum of 1 GB of hard disk space is recommended.

The USB scanner can only operate under the Microsoft Windows 7 / 8 / 10 operating system.

HARDWARE REQUIREMENTS

This scanner connects to your computer through the Universal Serial Bus (USB) which supports HOT PLUG AND PLAY. To determine whether your computer is USB-capable, you must check the rear of your PC to locate a USB jack that looks like the picture below. If you are having trouble in locating the USB port on your computer, please refer to the hardware manual that came with your computer.

Upon examination, you should find one or two rectangular USB ports, which usually appear as shown below.

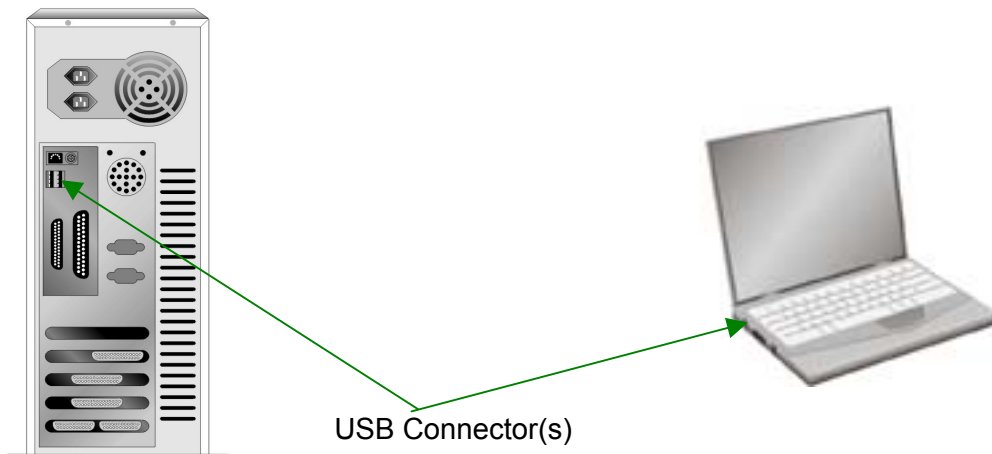

If you don’t find such USB ports on your computer, then you need to purchase a certified USB interface card to add USB capabilities to your computer.

INSTALLING AND SETTING UP THE SCANNER

Please follow the step-by-step procedures described below to install the Plustek scanner.

| | |
|---|---|
|  | Choose a Proper Site First! |
| Attention | <ul style="list-style-type: none">● Always place your scanner on a level, smooth and strong surface before proceeding the scanner setup or any scanning task. Tilted or uneven surface may cause paper-feeding errors, scanner damage or personal injury.● Avoid using the scanner in a dusty environment. Dust particles and other foreign objects may damage the unit. |

Step 1. Unlock Your Scanner

This scanner is designed with a locking mechanism to hold the scanning head in place during transportation. Before you connect your scanner with the computer, ensure to unlock your scanner first.

To unlock the scanner, slide the locking switch on the scanner's underside toward the back panel of the scanner until it snaps into place. Refer to the “

Scanner Lock” section of this guide for more details.

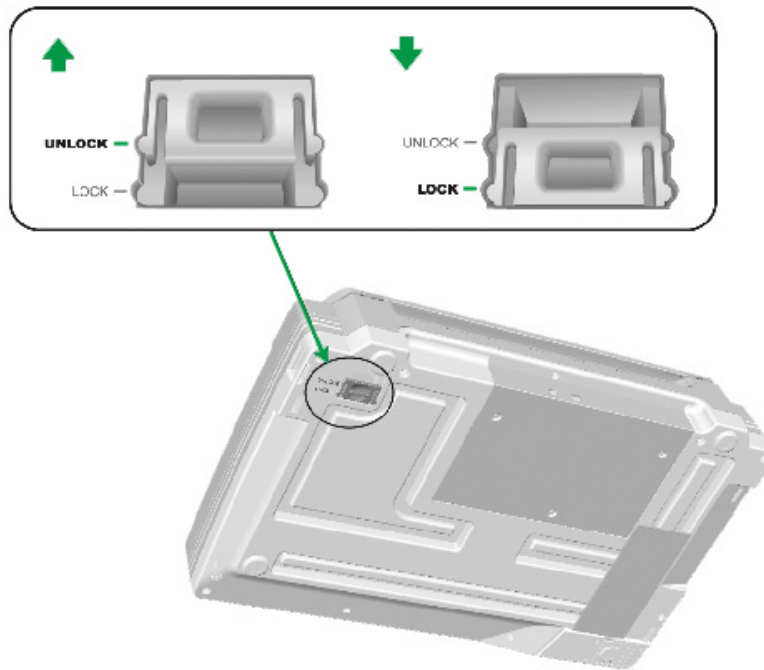

Step 2. Connecting the Scanner to Your Computer

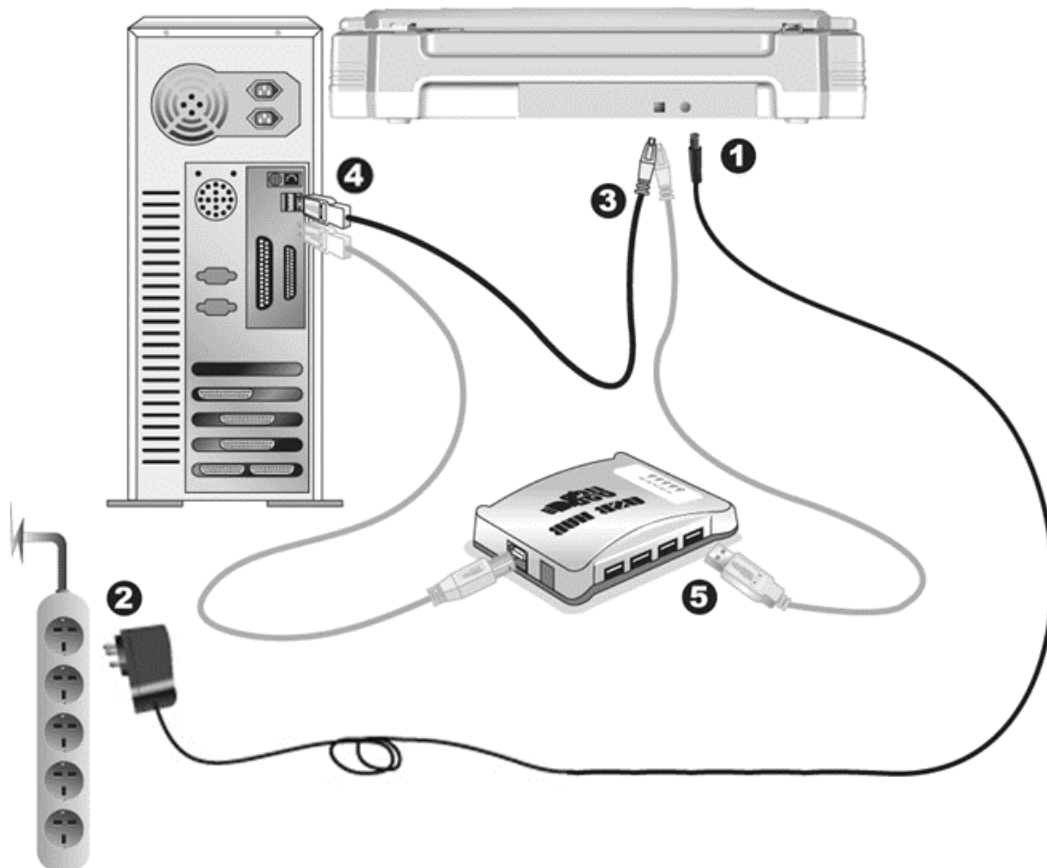



Attention

Please make sure the scanner is turned OFF before you plug or unplug the scanner power adapter.

1. Plug the AC adapter into the scanner's power receptor.
2. Plug the other end of the power cable into a standard AC power outlet.
3. Plug the square end of the included USB cable to the USB port at the rear of the scanner.
4. Plug the rectangular end of the USB cable to an available USB port on your computer.
5. If you plan to connect your scanner to a USB hub⁴, make sure that the hub is connected to the USB port in your computer. Next, connect the scanner to the USB hub.

Step 3. Installing the Software

1. Switch on the scanner power from the side of the scanner.
2. If the USB components on your computer are functioning correctly, they will automatically detect the scanner causing the **Add New Hardware Wizard** or **Found New Hardware Wizard** to be launched.



Information

If your computer is off when the scanner is connected, the "Add New Hardware Wizard" message will not be displayed until the computer is on and Windows starts.

3. For Windows 7:

When the Setup/Application DVD is for several scanner models

- a. Insert the Setup/Application DVD-ROM, included with your scanner, into your DVD-ROM drive. Click **Run install.exe** in the **AutoPlay** window.
- b. Click on the **Yes** button if the **User Account Control** dialog pops up. Follow the instructions in the pop-up installation message.
- c. In the **Device Manager** window, right-click on this scanner under **Other devices** and select **Update Driver Software** from the pop-up menu. Click **Browse my computer for driver software** in the window that appears, and click the **Browse** button.
- d. In the **Browse For Folder** window, select the folder or the DVD-ROM drive that contains this scanner's driver and click the **OK** button to return to the previous screen. Click the **Next** button and click **Install this driver software**

⁴ The USB hub is not included with the scanner.

anyway if the **Windows Security** window appears. Afterwards, please skip to procedure 5.

When the Setup/Application DVD is for one scanner model

- a. Insert the Setup/Application DVD-ROM, included with your scanner, into your DVD-ROM drive. Click **Run install.exe** in the **AutoPlay** window.
 - b. Click on the **Yes** button if the **User Account Control** dialog pops up. Afterwards, please skip to procedure 5.
4. For Windows 8 & Windows 10:
- a. Insert the Setup/Application DVD-ROM, included with your scanner, into your DVD-ROM drive. Click on the pop-up notification, then click **Run install.exe** in the pop-up window. If you miss the pop-up notification, please eject and re-insert the Setup/Application DVD-ROM.
 - b. Click on the **Yes** button if the **User Account Control** dialog pops up. Afterwards, please skip to procedure 5.
5. Follow the on-screen instructions to install all software that your new scanner requires. If the pop-up wizard window appears click **Next**, and click **Install this driver software anyway** in the **Windows Security** window then click **Finish** in the wizard window.
6. After the software is installed, close all open applications and click the **Finish** button to restart your computer.

| | |
|---|---|
|  | Save the Setup/Application DVD in case you need to reinstall the driver and software in the future. |
| Attention | |



Step 4. Testing the Scanner

The following describes how you can check if the scanner is properly functioning with your computer and the scanning software. Before testing your scanner, double check to make sure that all connections are securely fastened.

To test the flatbed scanning:

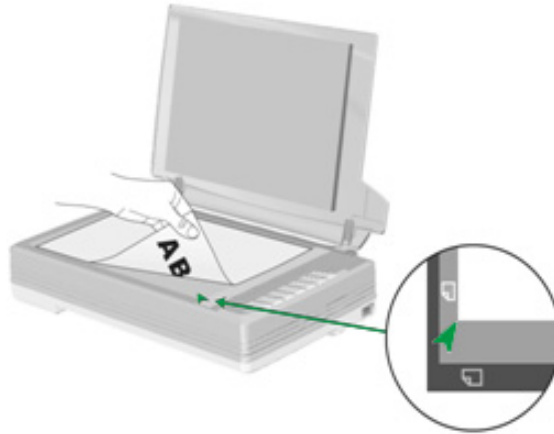
1. Open the scanner's document cover. Place the document onto the scanner glass headfirst and face-down. Align the top left corner of the document with the arrow on the reference mark.



2. Gently close the document cover.
3. Do one of the following to open the Button Configuration window:
 - Double-click the DocAction icon  in the Windows system tray.
 - Right-click the DocAction icon  in the Windows system tray, and then choose **Button Configuration...** in the pop-up menu that opens.
4. Clicking the “1” icon on the left pane in the Button Configuration window displays its current button settings on the right pane. In the Button Configuration window, choose from the dropdown list of Button Template to select “File Utility”, and keep in mind the default saving folder show in the “Saving folder” dropdown list.
5. Press the “1” button on the scanner and the scanning starts immediately. You’ll see a scanned image of the document in the default saving folder; your scanner is working properly.

INSTALLING ADDITIONAL SOFTWARE

Your scanner is TWAIN compliant and functions with virtually all available TWAIN compatible software. If you purchase additional software to be used with your scanner, please make sure that it conforms to the TWAIN standard.

CHAPTER II. SCANNING

Your scanner needs to be driven by certain type of software program. Since all documents or images (whether text or pictures) that are acquired from the scanner are treated by your computer as images, most scanning will probably be done from an image-editing program where you can view, edit, save and output the scanned images.

What about scanning text documents and editing them in a word processor? This is the role of Optical Character Recognition (OCR) software. OCR software converts the image files that are created from scanning text documents into text files that can be viewed, edited and saved by word processors.

The DocAction program, seamlessly integrating the operation of your scanner with your computer and other peripherals, provides a quick and convenient way to perform various scanning functions. With DocAction, you don't need to adjust settings every time you scan. Simply press any button on the scanner's front panel or click any scanning menu item of DocAction on the screen. The scanner starts to scan your paper documents and transfer them to your assigned destination. The destination can be a printer, your e-mail program, files on your disk drives, an image-editing program, etc.

Please refer to the online help of each program to guide you through any questions you may have while scanning within that program.

This chapter describes three important steps of scanner operations. Read them thoroughly and follow the instructions to ensure correct use and optimal scanner performance.

Step 1. Preparing Documents

Step 2. Placing Documents

Step 3. Scanning Documents

PREPARING DOCUMENTS

Proper document preparation prior to the scan can prevent paper feed errors and damages to the scanner.

- Checking Document Conditions

Checking Document Conditions

Make sure the paper sizes of your documents are acceptable by the scanner. Refer to "Appendix A: Specifications4F" of this guide for more information.

PLACING DOCUMENTS

Using the Flatbed

1. Open the scanner's document cover.
2. Place the document onto the scanner glass headfirst and face-down. Align the top left corner of the document with the arrow on the reference mark.

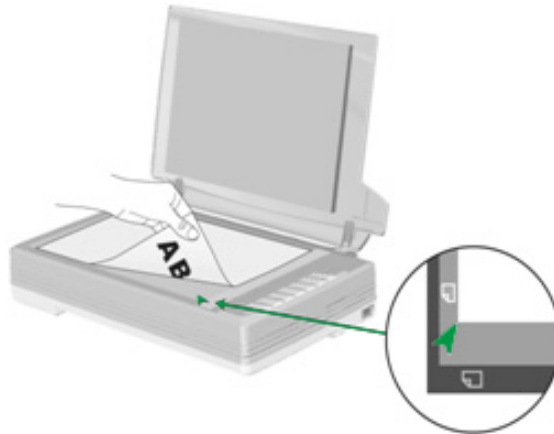

3. Gently close the document cover.

SCANNING DOCUMENTS

There are 4 different ways to operate the scanner:

1. By acquiring images from the scanner through our TWAIN interface within any TWAIN-compliant application programs.
2. By scanning from the scan buttons on the scanner.
3. By scanning from DocAction's Execute menu on the screen.
4. By scanning from the icon in the left side of the DocAction window.

The TWAIN interface and DocAction software are automatically installed to your system along with the scanner driver.



Attention

Before you start scanning, check the following:

- Your scanner has been unlocked and the power of both your computer and scanner is turned on.
- The icon  appears on the Windows system tray.
- Paper is appropriately placed on the scanner flatbed glass.

Scanning via TWAIN Interface

The TWAIN program is a very important piece of software that comes with your scanner. This program acts as an interface between the scanner hardware and the image-editing software you are using to view and edit images. The TWAIN program allows you to adjust a number of settings to define the quality of the scanned image.

The following describes how you may use your TWAIN compatible program to scan via the TWAIN interface. When you get familiar with the scanning, you may alternatively use other TWAIN compatible scanning programs or image-editing applications to do your scanning projects.

Scan within your TWAIN compatible program:

1. Launch your TWAIN compatible program.



Attention

If you have more than one scanner or other imaging devices installed on your computer, you need to set this scanner as the default scanning source before you acquire the TWAIN program. Please refer to your TWAIN compatible program manual for more information about the settings.

2. Open the TWAIN window within your TWAIN compatible program. Please refer to your TWAIN compatible program manual for detailed information.
3. In the TWAIN window that opens, select **Flatbed Reflective** as the Scan Type.

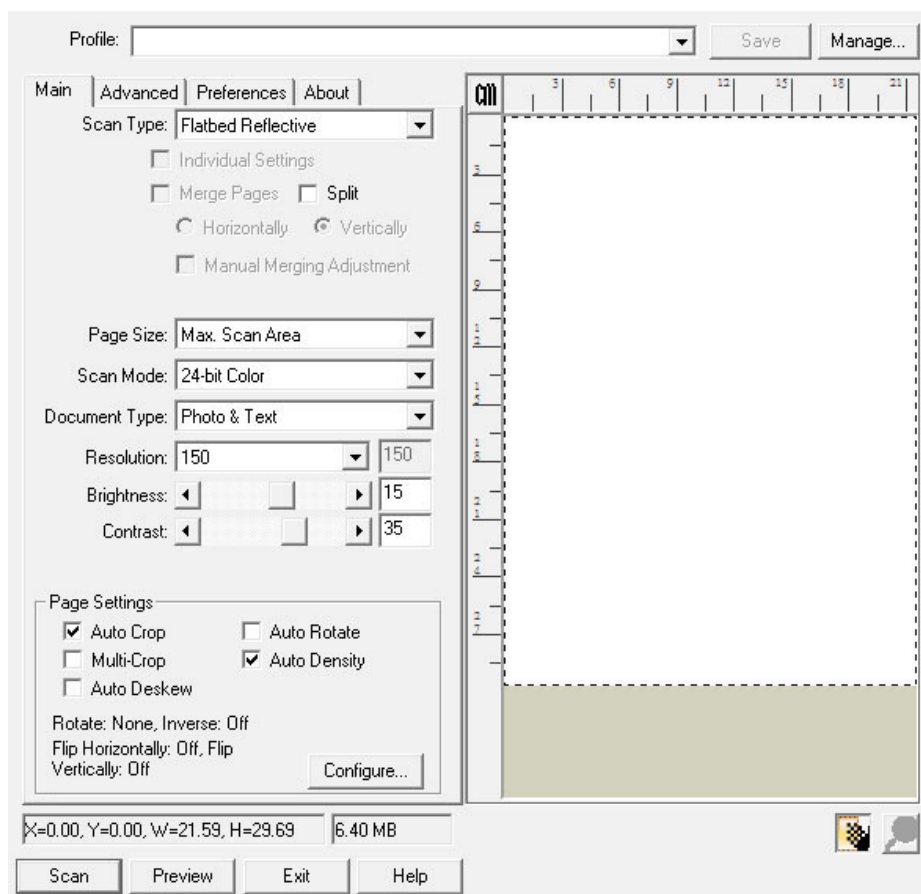

4. Adjust the scanning settings.
5. Click the **Preview** button. The scanned image should appear in the Preview Window. To define the margins and crop out sections of the image you don't want scanned, use the mouse to click and drag the corners or sides of the scan area borders. Adjust the scan settings again if the preview image doesn't satisfy your needs.
6. Click the **Scan** button.
7. When the scan finishes, click the **Exit** button to close the TWAIN window. The scanned images are displayed in your TWAIN compatible program, and you may perform the image editing tasks.

Click the **Help** button within the TWAIN window for more information about the settings.



Scanning from the Scanner's Panel or On-screen DocAction's Execute Menu

The settings for each button on the scanner's panel are configured through DocAction. DocAction offers you quick access to the most frequently-used scanning functions. They are especially useful when you need to repeatedly scan with the same settings and send images to the same destination.

Buttons on the scanner panel will be used in this guide to demonstrate the scanner operations. You may also use DocAction's on-screen Execute menu to perform the same scanning tasks.

Configure Button Settings

Before performing your first scan via scanner buttons, you are recommended to configure the button settings to your needs and preferences first. There are two ways to configure or view the button settings of DocAction:

- Double-click the icon  in the Windows system tray.
- Right-click the icon  in the Windows system tray, and then choose **Button Configuration** in the pop-up menu that opens.

Within the "Button Configuration" window, you can find a row of icons running through the left side of the window. Each icon corresponds to a button on your scanner's panel (as well as DocAction's on-screen Execute menu). Clicking any icon on the left pane and its current button settings are displayed immediately on the right pane. You may adjust the settings as desired.

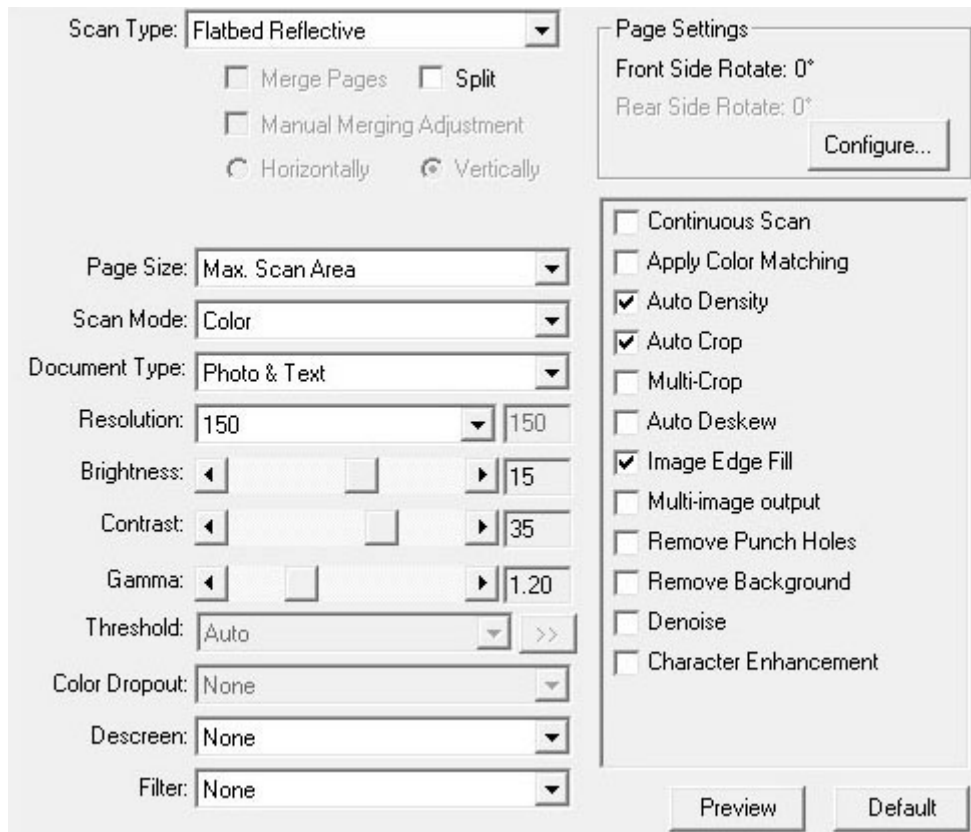

Click the **Help** button within the Button Configuration window for more information about the settings.

Scan from the Buttons

Scanning documents or images from this scanner is very easy. Follow the two steps described below:

1. Place the document or images onto the scanner. (Refer to “Chapter II. Scanning” of this guide for more information in placing paper on the flatbed glass properly.)

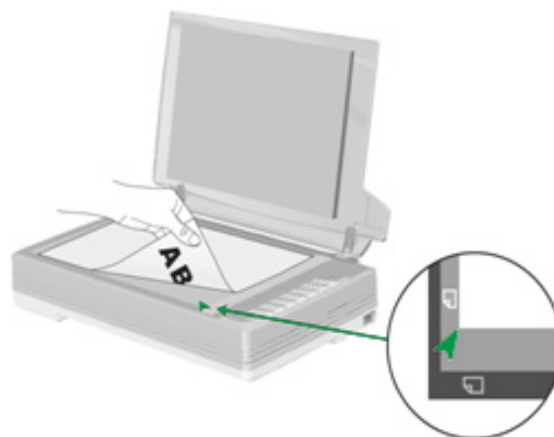





Attention

Place only text documents for OCR purposes. Do not scan a photo using the OCR button.

2. Do one of the following to start scanning:

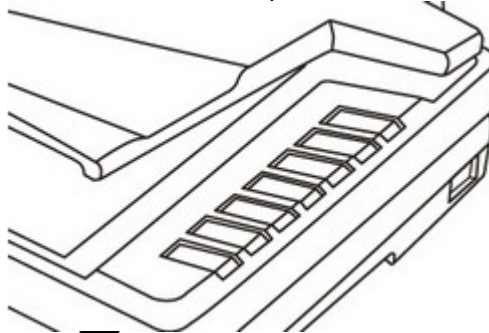
- Press the button from the scanner's panel.



- Right-click the icon  in the Windows system tray, and then choose Execute in the pop-up menu that opens. Click the desired button function item in the pop-up menu.

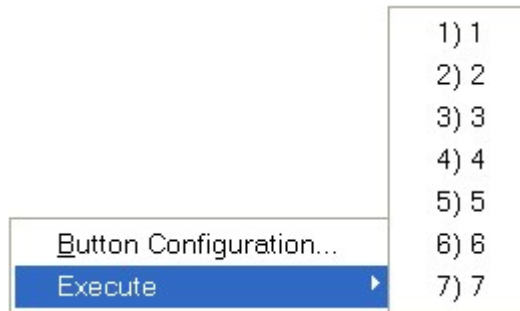

The scanner starts to scan immediately and carry out the corresponding action according to the settings you have set up in the Button Configuration window.

Scanning from the Icon in the Left Side of the DocAction Window

You can perform scanning task by double-clicking the icon in the left side of the DocAction window. Follow the steps described below:

1. Place the document or images onto the scanner.

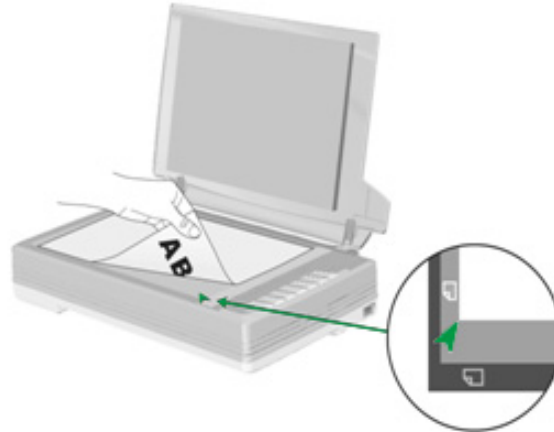

2. Check current button settings by viewing the Button Configuration window. If needed, you may also modify settings to meet your current needs.

The Button Configuration window displays the following settings:

- Scan Type: Flatbed Reflective
- Merge Pages Split
- Manual Merging Adjustment
- Horizontally Vertically
- Page Size: Max. Scan Area
- Scan Mode: Color
- Document Type: Photo & Text
- Resolution: 300
- Brightness: 15
- Contrast: 35
- Gamma: 1.20
- Threshold: Auto
- Color Dropout: None
- Descreen: None
- Filter: None
- Page Settings: Front Side Rotate: 0°, Rear Side Rotate: 0°
- Continuous Scan
- Apply Color Matching
- Auto Density
- Auto Crop
- Multi-Crop
- Auto Deskew
- Image Edge Fill
- Remove Punch Holes
- Remove Background
- Denoise
- Character Enhancement

Buttons: Preview, Default

3. Double-clicking the desired icon in the left side of the DocAction window.



The scanner starts to scan immediately and carry out the corresponding action according to settings you have set up in the Button Configuration window.

CHAPTER III. CARE AND MAINTENANCE

Your scanner is designed to be maintenance-free. However, constant care and maintenance can keep your scanner working smoothly.

CLEANING THE SCANNER

Paper powder, dust, ink and toner from paper being scanned may make the scanner glass dirty, which leads to poor image quality or document-feeding errors. How often to clean your scanner depends on the type of paper and number of pages being scanned.

Perform the following procedures to clean the scanner surface and scanner glass. Gently wipe locations described herein. Do not rub too hard.



Warning

- Before cleaning the scanner, turn off the scanner and disconnect the scanner's power cable and USB cable, and then wait a few minutes for the glass to cool to ambient temperature.
- Wash your hands with soap and water after cleaning the scanner.

Cleaning Materials

Have the following cleaning materials ready to clean the scanner:

- **soft, dry, lint-free cloth (or a cotton swab)**
- **non-abrasive cleaner**—Isopropyl alcohol (95%). DO NOT use water.



Attention

Alternatively you can use glass cleaner or neutral detergent for windows cleaning to clean the scanner glass.

Use of other cleaning materials could damage your scanner.

Cleaning the Flatbed

1. Open the document cover.
2. Gently wipe the following areas with the cloth dampened with the cleaner.

Clean Document Pad & Scanner Glass:

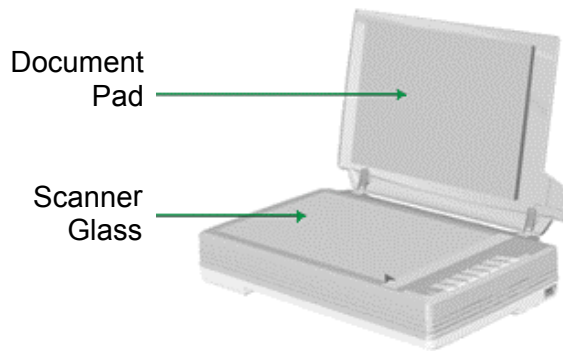

3. Wait for cleaned areas to dry completely.
4. Gently close the document cover.

ALIGNING THE SCANNER

In most cases, the scanner doesn't need to be aligned but there are instances when the alignment might be required. You need to align the scanner only if parts of the scanned document are missing from any of its edges. For example, the heading of a document might be missing from the top edge after the document has been scanned.

Alignment for Flatbed Scan:

1. Place the document onto the scanner glass headfirst and face-down. Align the top left corner of the document with the arrow on the reference mark.
2. Right click the icon  on the Windows system tray and select **Scanner Utility** from the menu that pops up.
3. The Scanner Utility window opens. Find the **Initial Scanning Position Alignment** section and select **Flatbed Reflective** as the source.

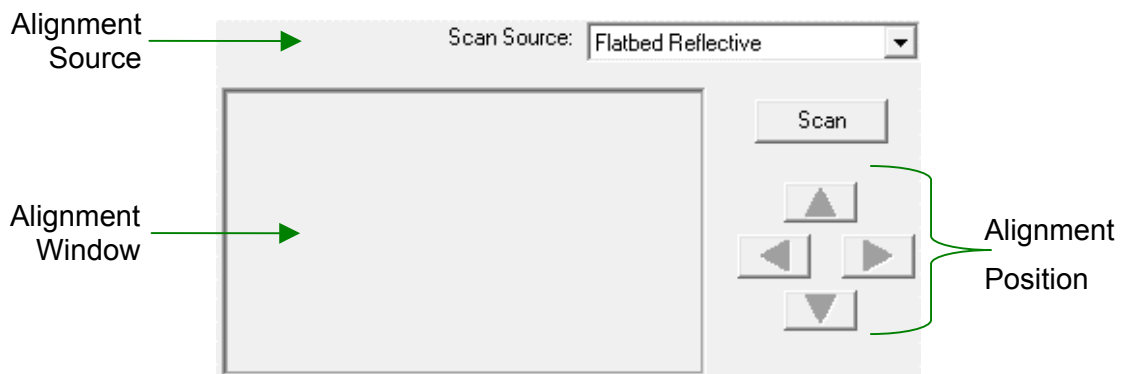



4. Click the **Scan** button. Part of the document image will be displayed in the Alignment Window.

5. Click the **Alignment Position** buttons (Up, Down, Left, Right) until the top left corner of the scanned document aligns with the top left corner of the Alignment Window.
6. When the alignment completes, click on **OK** button to save settings and exit.

STANDBY MODE

To save power consumption, the scanner will enter the standby mode after it is idle for a while. You may disable the standby mode or define an idle time for the scanner to automatically enter the standby mode.

1. Right click the icon  on the Windows system tray and select **Scanner Utility** from the menu that pops up.
2. In the **Standby Mode** section of the Scanner Utility window that opens, click the button of your option:
 - a. To disable the Standby Mode: Click the button before **Disable Standby Mode**.
 - b. To automatically enter the Standby Mode (**Sleep**): Click the button before **Sleep** and then click the up or down arrows to set a default time for the scanner to automatically enter the Standby Mode.

| | |
|---|--|
|  | The scanner will enter the standby mode after it is idle for 10 minutes. Simply press any scanner button on the scanner panel and the scanner will return back to the normal status. |
|---|--|

3. Click on **OK** button to save settings and exit.

| | |
|---|---|
|  | <ul style="list-style-type: none">● To completely shut down the scanner, press the power switch on the side of the scanner.● If the scanner will not be used for a long period of time, shut down the scanner and then disconnect the power cable from the power outlet. |
|---|---|

Alternatively you may click **Default** to restore the default settings. You may press any scanner button to wake up the scanner from power saving.

SCANNER LOCK

Your scanner is designed with two different lock statuses to protect the optical parts. To ensure the scanner working properly, you have to choose an appropriate lock status according to the situation.

Always Unlock:

A scanning-ready status. Furthermore, if you place your scanner on a long-term position, you can also keep your scanner lock in this status. To unlock the scanner, slide the locking switch on the scanner's underside toward the back panel of the scanner until it snaps into place.

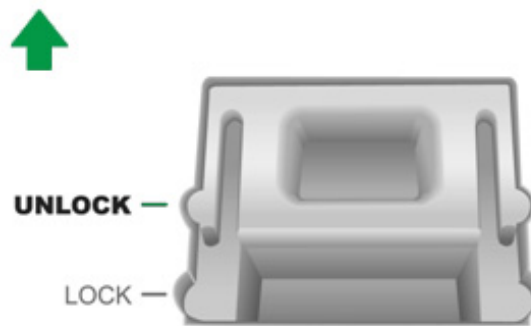

Always Lock:

It holds the scanning head in place during transportation and traveling. The scanner will be kept in disabled status. To lock the scanner, slide the locking switch on the scanner's underside toward the power LED of the scanner until it snaps into place.

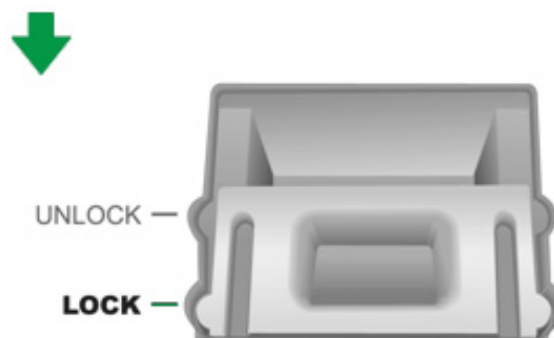

Warning

When you need to move the scanner, do lock the scanner to ensure accurate and problem-free use of your scanner.



CHAPTER IV. TROUBLESHOOTING

If you encounter problems with your scanner, please review the installation and scanning instructions contained in this guide.

Before you ask for customer service or repair, please refer to the information in this chapter and consult our FAQ (Frequently Asked Questions) in which you can find useful self troubleshooting information. From the Windows **START** menu, point to **All Programs > Your Scanner Model Name**, and then click **FAQ**. (For Windows 8.1 users: Point your mouse cursor to the upper or lower right corner of your screen to open the **Charm** bar. Click on the **Start** charm, then click on the downwards arrow button in the lower left corner of the screen. The **Apps** screen will be shown. Move your cursor to the right edge of the screen to scroll right until you find **Your scanner model name**, and then click on **FAQ**.)

SCANNER CONNECTION

The first step to take when troubleshooting connection problems with your scanner is to check all physical connections. The icon , located on the Windows system tray, indicates if the scanner software is properly launched and the scanner and computer are communicating with each other.

| Appearance | Status |
|---|---|
|  | The program has been successfully launched and the scanner is connected with the computer, ready to scan images. |
|  | The scanner is not connected with the computer. Or, the scanner power is not switched on. Or, the scanner is in standby mode. |
| No Display | You have chosen to terminate the program, no matter the scanner is connected or disconnected with the computer. |

APPENDIX A: SPECIFICATIONS⁵

| Plustek OpticPro A320E | |
|-------------------------------|--|
| Image Sensor | CCD |
| Optical Resolution | 800 dpi |
| Scan Modes | Color: 48-bit input, 24-bit output Grayscale: 16-bit input, 8-bit output B/W: 1-bit output |
| Color Depth | Input 48-bit; Output 24-bit |
| Scanning Speed | 7.8 sec (Color/ Grayscale/ B&W mode, 300dpi, A3) |
| Scanning Area (W x L) | Max. 304.8 mm x 431.8 mm (12" x 17"), A3 |
| Daily Duty Scan (Sheets) | 2,500 |
| Action Button | 1~7 |
| Power Supply | 24 Vdc/ 1.0 A |
| Power Consumption | ≤30 W (operation), ≤2.9 W (idle), ≤0.3 W (standby) |
| Interface | USB 2.0 |
| Net Weight | 7.5 Kgs (16.52 Lbs) |
| Dimensions (W x D x H) | 623 x 400 x 140 mm (24.53" x 15.75" x 5.51") |
| Protocol | TWAIN Compliant, WIA |

⁵ Hardware specifications may change at any time without prior notice.

APPENDIX B: CUSTOMER SERVICE AND WARRANTY

Visit our website www.plustek.com for more customer service information.

To avoid delays, please have the following information available:

- Scanner name and model number
- Scanner serial number (located at the bottom of the scanner)
- Scanner DVD version and part number
- A detailed description of the problem
- Your computer manufacturer and its model number
- The speed of your CPU
- Your current operating system and BIOS (optional)
- Name of software package(s), version or release number and manufacturer of the software
- Other USB devices installed

SERVICE & SUPPORT INFORMATION (FOR EU COUNTRY ONLY)

Where appropriate, the period of availability of spare parts and the possibilities of upgrading products information. Please ask local distributors and suppliers for spare parts information and product upgrade information.

Information requested by relevant Implementing Measure. Please ask local distributors and suppliers for the related information of Implementing Measure test report.

Do not dispose anything of products before you ask local distributors and suppliers to get correct information for decreases of environmental impact with right methods and procedures.

If you want to disposals the product and/or an accessory, please ask local distributors and suppliers to get the contact information of nearest disposal manufactures.

If you have any maintenance inquiry, please ask local distributors and suppliers to get the contact information of nearest maintenance center in order to extend the product usage life time.

If you want to maintain and clearance the product, please ask local distributors and suppliers to get the right information of nearest stores.

STATEMENT OF LIMITED WARRANTY

This Statement of Limited Warranty applies only to the options you originally purchase for your use, and not for resale, from an authorized reseller.

The manufacturer warranty includes all parts and labor, and is not valid without the receipt of original purchase. To obtain warranty service, you may contact the authorized dealer or distributor, or visit our website to check out the available service information, or send a request via E-mail for further help.

If you transfer this product to another user, warranty service is available to that user for the remainder of the warranty period. You should give your proof of purchase and this statement to that user.

We warrant that this machine will be in good working order and will conform to its functional descriptions in the documentation provided. Upon provision of proof of purchase, replacement parts assume the remaining warranty of the parts they replace.

Before presenting this product for warranty service, you must remove all programs, data and removable storage media. Products returned without guides and software will be replaced without guides and software.

This Limited Warranty service does not provide for carry-in exchange when the problem results from accident, disaster, vandalism, misuse, abuse, unsuitable environment, program modification, another machine or non-vendor modification for this product.

If this product is an optional feature, this Limited Warranty applies only when the feature is used in a machine for which it was designed.

If you have any questions about your Limited Warranty, contact the approved retailer from whom you bought the product or the manufacturer.

THIS LIMITED WARRANTY REPLACES ALL OTHER WARRANTIES, EXPRESS OR IMPLIED, INCLUDING, BUT NOT LIMITED TO, THE IMPLIED WARRANTIES OF MERCHANTABILITY AND FITNESS FOR A PARTICULAR PURPOSE. HOWEVER, SOME LAWS DO NOT ALLOW THE EXCLUSION OF IMPLIED WARRANTIES. IF THESE LAWS APPLY, THEN ALL EXPRESS AND IMPLIED WARRANTIES ARE LIMITED IN DURATION TO THE WARRANTY PERIOD. NO OTHER WARRANTIES APPLY AFTER THAT PERIOD.

Some jurisdictions do not allow limitations on how long an implied warranty lasts, so the above limitation may not apply.

Under no circumstances are we liable for any of the following:

1. Third party claims against you for losses or damages.
2. Loss of, or damage to, your records or data; or
3. Economic consequential damages (including lost profits or savings) or incidental damages, even if we are informed of their possibility.

Some jurisdictions do not allow the exclusion or limitations of incidental or consequential damages, so the above limitation or exclusion may not apply to you.

This Limited Warranty gives you specific legal rights, and you may also have other rights that vary from jurisdiction to jurisdiction.

FCC RADIO FREQUENCY STATEMENT

This equipment has been tested and found to comply with the limits for a Class B digital device, pursuant to part 15 of the FCC rules. These limits are designed to provide reasonable protection against harmful interference in a residential installation.

This equipment generates, uses and can radiate radio frequency energy and, if not installed and used in accordance with the instructions, may cause harmful interference to radio communications. However, there is no guarantee that interference will not occur in a particular television reception (which can be determined by turning the equipment off and on), the user is encouraged to try to correct the interference by one or more of the following measures:

- Reorient or relocate the receiving antenna.
- Increase the separation between the equipment and receiver.
- Connect the equipment to an outlet on a circuit different from that which the receiver is connected.
- Shielded interconnect cables and shielded power cord which are supplied with this equipment must be employed with this equipment to ensure compliance with the pertinent RF emission limits governing this device.
- Consult the dealer or an experienced radio/TV technician for help if the conditions persist.
- Changes or modifications not expressly approved by the manufacturer or authorized service center could void the user's authority to operate this equipment.

This device complies with Part 15 of the FCC Rules. Operation is subject to the following two conditions: (1) this device may not cause harmful interference, and (2) this device must accept any interference received, including interference that may cause undesired operation.

DocTWAIN Online Help

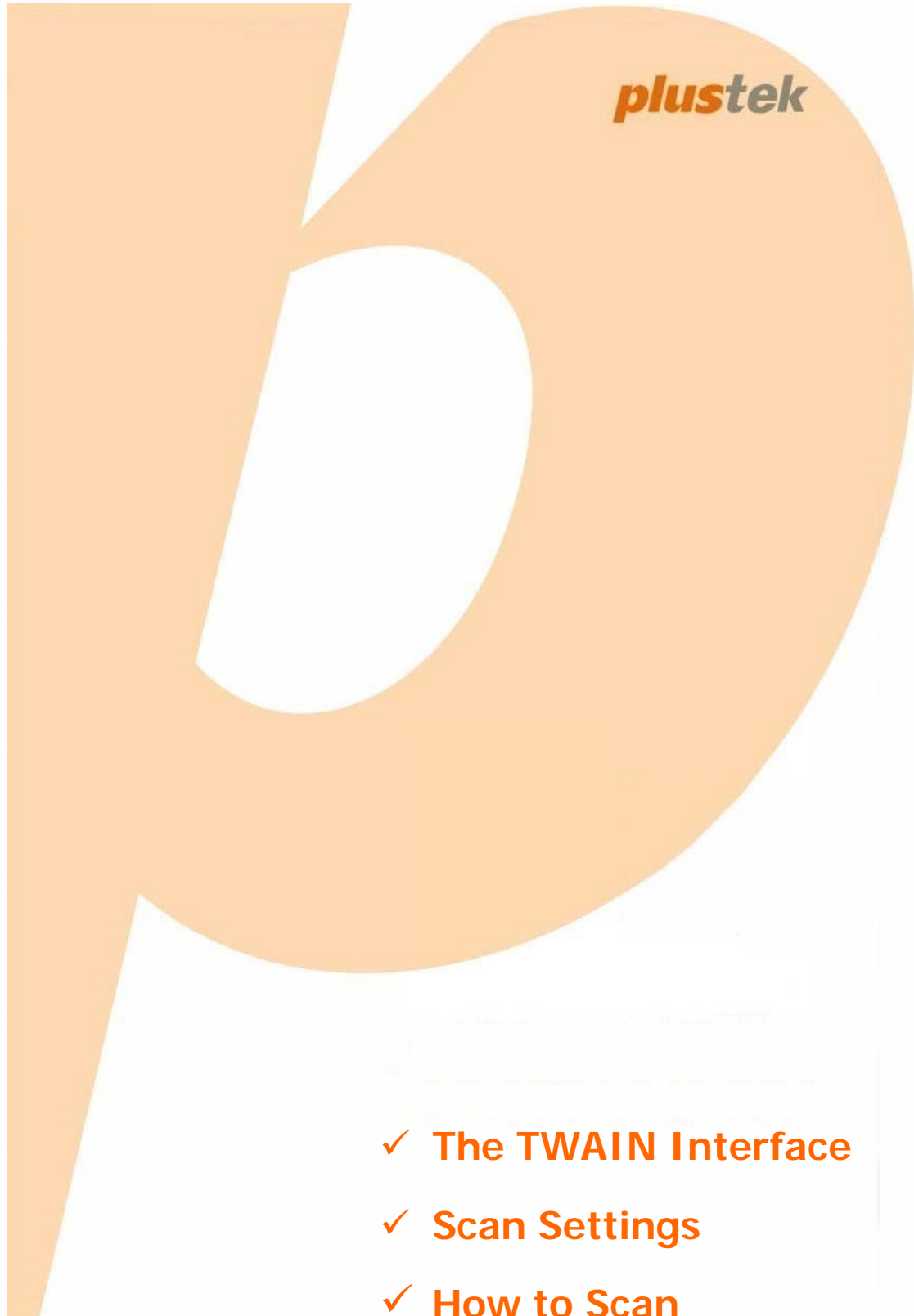

DocTWAIN: Table of Contents

| | |
|---|-----------|
| Part I Introduction | 3 |
| 1 User Assistance | 3 |
| 2 Scanner Information | 3 |
| Part II The TWAIN Interface | 4 |
| 1 Scan Profile | 5 |
| Profile Management | 7 |
| 2 Scan Settings | 8 |
| Main Tab | 9 |
| Scan Type..... | 9 |
| Split (This function may or may not be available depending on the scanner model you purchase)..... | 10 |
| Page Size..... | 10 |
| Scan Mode..... | 11 |
| Document Type..... | 11 |
| Resolution..... | 12 |
| Brightness..... | 13 |
| Contrast | 13 |
| Page Settings..... | 13 |
| Advanced Tab | 16 |
| Color Matching..... | 17 |
| Color Dropout..... | 18 |
| Descreen..... | 18 |
| Filter | 19 |
| Gamma | 19 |
| Histogram..... | 20 |
| HSL | 22 |
| Channel | 23 |
| Threshold..... | 23 |
| Preferences Tab | 25 |
| General | 26 |
| Auto Preview at Startup..... | 26 |
| Save Last Settings..... | 26 |
| Save Last Preview Image..... | 26 |
| Prompt dialog to show high resolution and large size scan reminder..... | 26 |
| Image Enhancement..... | 26 |
| Multi-image output (This function may or may not be available depending on the scanner model you purchase)..... | 28 |
| Image Edge Fill..... | 29 |
| Remove Punch Holes (This function may or may not be available depending on the scanner model you purchase)..... | 30 |
| Scan continuously..... | 31 |
| Split (This function may or may not be available depending on the scanner model you purchase)..... | 32 |
| 3 Preview Window | 33 |
| Scan Area | 35 |

| | |
|--|-----------|
| Magnifying Glass | 35 |
| Hand Tool | 36 |
| 4 Scan Information | 36 |
| 5 Preview | 37 |
| 6 Scan | 37 |
| 7 Exit | 37 |
| | |
| Part III How to Scan | 37 |
| | |
| 1 Step by Step Procedures | 38 |
| Scan by Profile | 38 |

1 Introduction

TWAIN is a standard regulating communication between imaging devices (e.g., scanner) and software applications. This scanner is TWAIN compliant and functions with virtually all available TWAIN compatible software.

This help will guide you in scanning with our TWAIN program.

The following Help Topics are available:

- [User Assistance](#)
- [Scanner Information](#)
- [TWAIN Interface](#)-- Explains all settings and tools in the TWAIN window.
- [How to Scan](#)-- Gives you step-by-step instructions for scanning documents and images.

1.1 User Assistance

Instant Descriptions "Tool Tips":

Rest the mouse pointer on any item within the window and a description of the item will instantly appear.

Help Button:

Clicking on this button runs the online help which answers questions about this program.

1.2 Scanner Information

Clicking on the **About** tab displays some information about your scanner and related software.

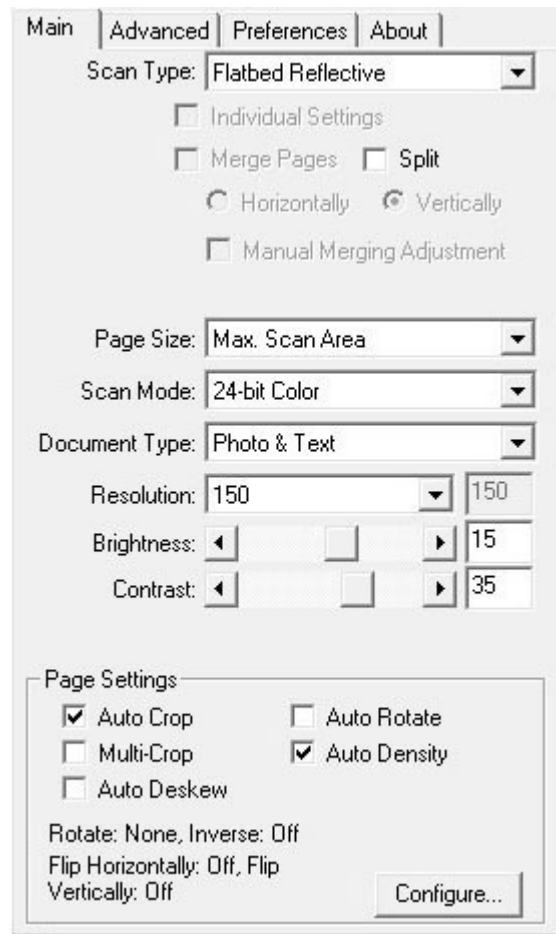

When you're looking for technical support, please keep the information ready.

2 The TWAIN Interface

The TWAIN program is a very important piece of software that comes with your scanner. This program acts as an interface between the scanner hardware and the image-editing software you are using to view and edit images. The TWAIN program allows you to adjust a number of settings to define the quality of the scanned image.

The TWAIN Interface allows you to make important adjustments before scanning. For example, you can scan in different modes: black and white, grayscale or color; increase or decrease the resolution (dots per inch of an image), and adjust the brightness and/or contrast.

The TWAIN interface consists of the following sections:

- [Scan Profile](#)
- [Scan Settings](#)
- [Preview Window](#)
- [Scan Information](#)
- Buttons

2.1 Scan Profile

A scan profile provides a set of scanning settings for often-used scan tasks, which achieves high efficiency when you want to scan several items with the same or similar settings.

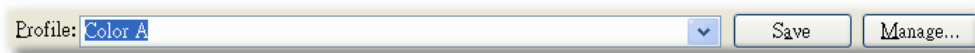

Each scan profile consists of the settings you configure in the [Main](#) and [Advanced](#) scan settings tabs and [Auto Density](#).

The following functions are available:

- [To create a new profile](#)
- [To use an existing profile](#)
- [To edit an existing profile](#)
- [To delete unwanted profile](#)
- [To rename an existing profile](#)
- [To save an existing profile as a new one](#)

To create a new profile

If you usually scan images with the same settings, you can define a scan profile to save the settings you have configured.

1. Place the document on the scanner glass.
2. Configure the settings. Scan an image to make sure the current settings meet your needs.
3. Enter a name or description for this new profile in the white area beside the word **Profile**.
4. Click the **Save** button.

(To save your time in configuring the settings, alternatively you may select a scan profile whose settings are closest to your needs from the drop-down list of Profile.)

A new profile is now created! Next time when you want to scan similar documents and apply the same settings, you can just select this profile from the drop-down list and then click the **Scan** button.

To use an existing profile

1. Place the document on the scanner glass.
 2. Select a scan profile from the drop-down list of **Profile**. Scan settings defined under this profile are loaded and displayed on the TWAIN interface.
 3. Click the **Scan** button.
 4. The image(s) will be scanned with the preconfigured settings. No need to spend extra time in configuring the scan settings.
-

To edit an existing profile

1. Place the document on the scanner glass.
2. From the drop-down list of **Profile**, select the scan profile you want to edit.
3. Configure the settings. Scan an image to make sure the current settings meet your needs.
4. Enter the original profile name in the white area beside the word **Profile**.
Note: Do not select this original profile name from the drop-down list of Profile. Doing so will load the original settings to overwrite what you have just configured.
5. Click the **Save** button.

This scan profile is now updated with the new settings.

To Manage Existing Profiles

Clicking the Manage button opens the [Profile Management](#) window where you can delete or rename existing profiles, as well as save existing profiles as new ones.

2.1.1 Profile Management

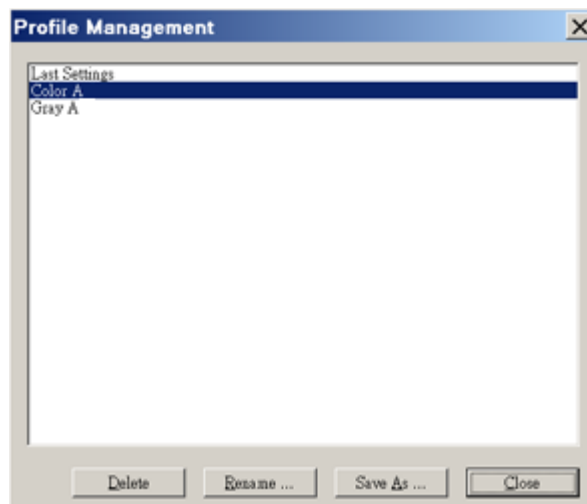

To delete unwanted profile

1. Click the **Manage** button.
2. Within the Profile Management window that opens, select the profile you want to delete and then click the **Delete** button.
3. Click the **Close** button to exit this window.

To rename an existing profile

1. Click the **Manage** button.
2. Within the Profile Management window that opens, select the profile you want to rename and then click the **Rename** button.
3. Type the new name in the "Profile - Rename" dialog box and then click **OK** button.
4. Click the **Close** button to exit this window.

To save an existing profile as a new one

1. Click the **Manage** button.
2. Within the Profile Management window that opens, select the profile you want to save as a new one and then click the **Save As** button.
3. Type the new name in the "Profile - Save As" dialog box and then click **OK** button.

- Click the **Close** button to exit this window.

2.2 Scan Settings

The following scan settings are available:

- [Main Tab](#)
- [Advanced Tab](#)
- [Preferences Tab](#)

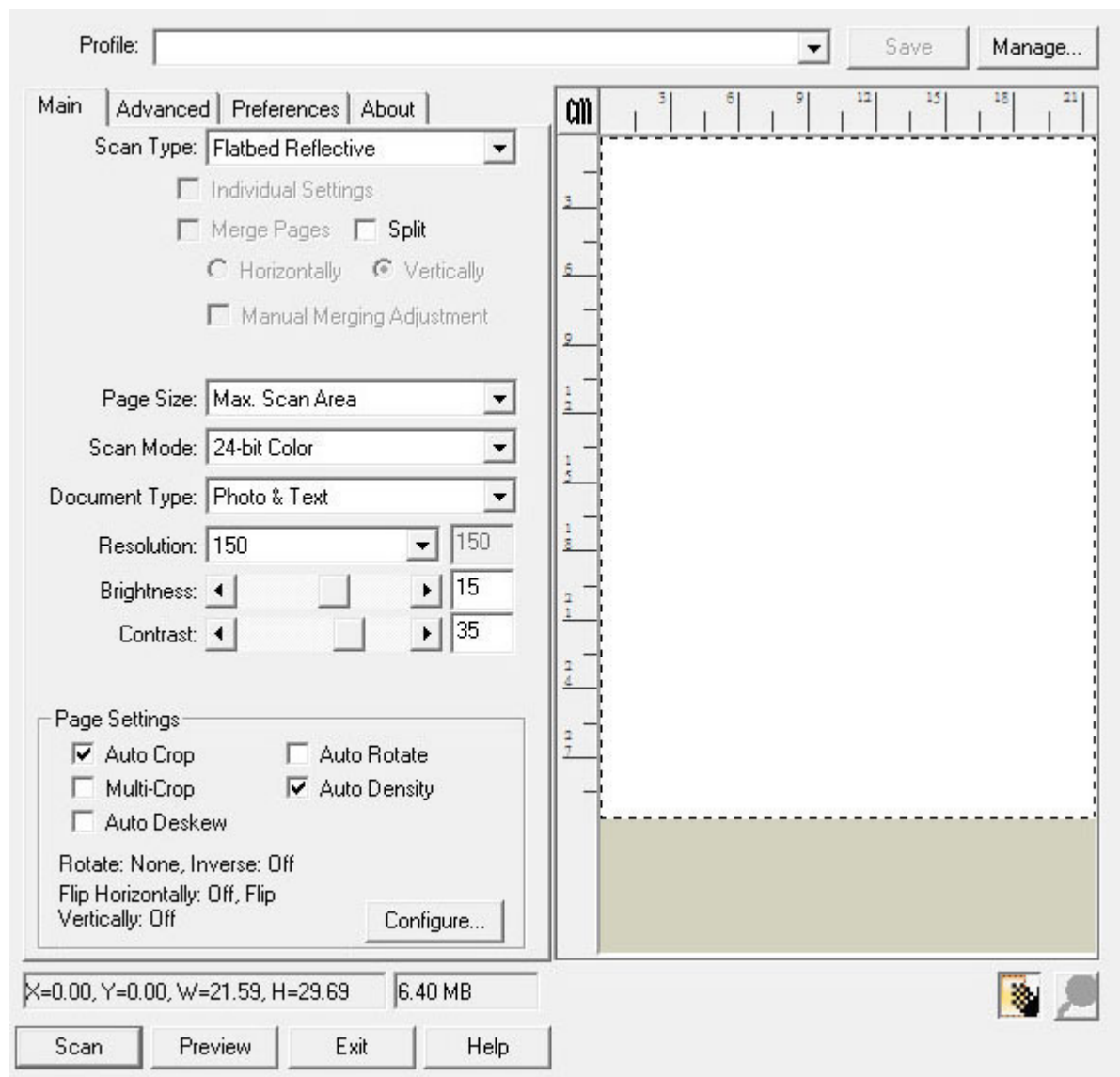

Clicking anywhere on the above screenshot links you immediately to more detailed information of the selected setting.

2.2.1 Main Tab

Main Tab contains some frequently used scanning settings.

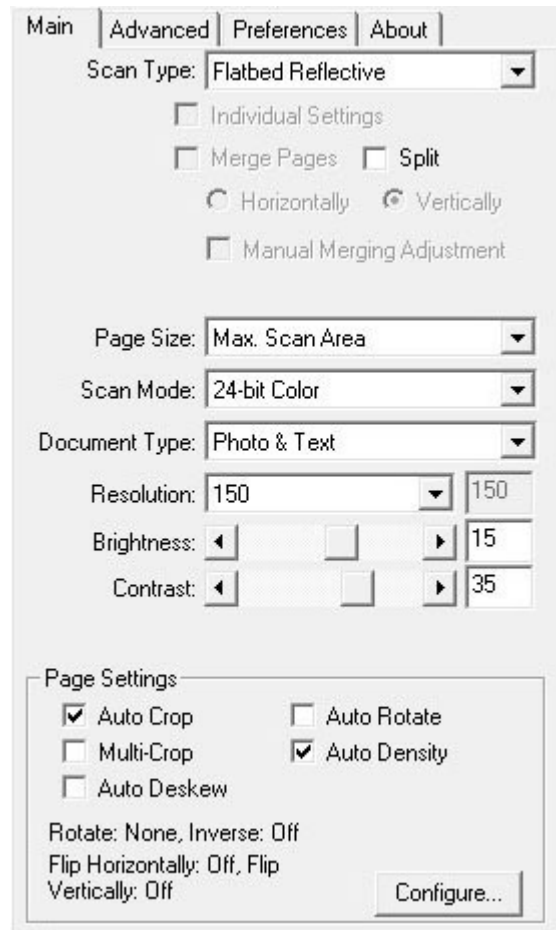

Clicking anywhere on the above screenshot links you immediately to more detailed information of the selected function.

2.2.1.1 Scan Type

Tells the scanner the method you will use to scan documents or images. The following options are available from the drop-down list:

- **Flatbed Reflective**-- Use this setting to scan normal sheets of paper or any non-transparent material directly from the scanner glass.

2.2.1.2 Split (This function may or may not be available depending on the scanner model you purchase)

Tick the check box of **Split**, a scanned image will be split in two equal halves and each equal half is called a page.

Check the radio button of **Horizontally** and the scanned image can be split horizontally. Check the radio button of **Vertically** and the scanned image can be split vertically. You can make the selection of **Horizontally** or **Vertically** only when the function of **Split** is enabled.

2.2.1.3 Page Size

Adjust this setting to tell the scanner the size of paper to scan, which is displayed on the [Preview Window](#) immediately.

Popular paper sizes have been preset in this TWAIN program. If you select **Custom...** from the drop-down list, a **Custom Page Size** dialog box opens and you may tailor the page size for documents frequently scanned.

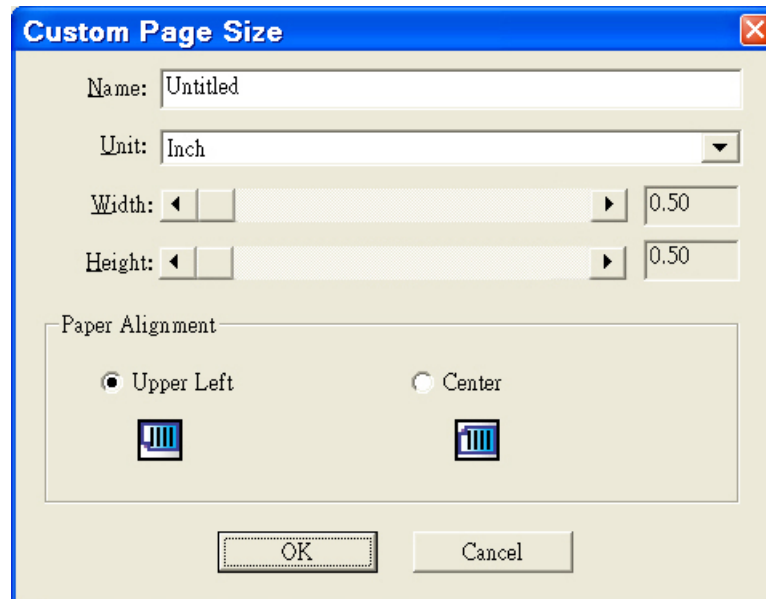

Name:

Give a name to this customized page size. After you configure the page size and click the **OK** button, this name will appear in the **Page Size** drop-down list.

Unit:

Defines the measurement unit for the page size.

Width, Height:

Specifies the exact width and height of the page area.

Paper Alignment:

This setting tells the scanner how you place the document on the scanner glass.

When **Flatbed Reflective** is selected as the [Scan Type](#):

- **Upper Left:** Place a document face down onto the scanner glass and align the document top with the arrow on the reference mark.
- **Center:** Align the center top of the document with the center of scanner glass's right side.

2.2.1.4 Scan Mode

Tells the scanner what type of documents you are scanning. The following options are available from the drop-down list:

- **Black & White**-- scans in black and white and is suitable for scanning text.
- **Grayscale**-- scans in 256 shades of gray, giving black and white images depth and shadow.
- **24-bit Color**-- scans in millions of colors (24-bit) but takes up a lot of memory.
- **256 Color (8-bit)**-- scans in standard 256 colors. The image quality of its resulted image is inferior than that of "24-bit Color", but its data size is smaller. Choose this mode if you want to scan color documents but care more on the file size than image quality.
- **Auto**-- use this setting if you want the scanner to detect the scan mode automatically. (This function may or may not be available depending on the scanner model you purchase.)

2.2.1.5 Document Type

This function allows you to select the type of content on the scanned documents for better scanning results. The following options are available from

the drop-down menu:

- **Custom**-- Use this setting to process the scanned document when other image enhancement functions are adjusted. This option allows you to customize the image setting parameters for your current needs. If you select this option and don't modify any image setting, the previous image settings will be applied.
- **Default**-- Use this setting to process the scanned document by the default values.
- **Photo**-- Use this setting to process the document contains mostly photographs. This feature is not available when **Black & White** is selected as Scan Mode.
- **Photo & Text**-- Use this setting to process the document contains a mix of graphics and texts.
- **Text**-- Use this setting to process the document contains mostly texts. This setting is available only when **Black & White** is selected as Scan Mode.

2.2.1.6 Resolution

Resolution is measured in dots per inch (dpi). The higher the resolution, the more detailed the image and the more memory and drive space the image will use.

To conserve computer memory and still receive good image quality, we recommend the following settings.

| Document to be scanned | Resolution (dpi) |
|-------------------------------|-------------------------|
| Text (for printing) | 300 |
| Text (for faxing) | 200 |
| Text (for OCR) | 300 |
| Black and white or gray image | 150 |
| Color image or photo | 100 |



- These values are only recommendations and should be raised if the resulting image is rough or you need to view fine details.
- To scan a large-size color image with a higher resolution (usually over 600 dpi) increases scan time and file size substantially and requires huge system resources. Therefore, a higher resolution for color scanning is recommended only when you scan a small area.

2.2.1.7 Brightness

Raising the brightness increases the amount of white in an image, making it appear more washed out. Lowering the brightness may help you read light or faint text.

You may adjust the brightness either way:

- Slide the thumb of the scroll bar to the right or left, which adds lightness or darkness to all colors in your image.
- Click the arrow signs on the right and left ends.

The current value is shown to right of each scroll bar.

2.2.1.8 Contrast

The higher the contrast, the sharper the image. The lower the contrast, the more blurry an image will be.

You may adjust the contrast either way:

- Slide the thumb of the scroll bar to the right or left, which raises or lowers the differences between light and dark colors in your image.
- Click the arrow signs on the right and left ends.

The current value is shown to right of each scroll bar.

2.2.1.9 Page Settings

Auto Crop

Clicking this Auto Crop box will have the TWAIN program identify the dimensions of the image you scanned and crop around the edges. The crop shape will be a square or rectangle, in that it will not hug the edges of oddly-shaped images. This command can be useful when scanning smaller images

such as photographs.

However, if you manually adjust the scan frame, the Auto Crop will be automatically cancelled.

Multi-Crop (This function may or may not be available depending on the scanner model you purchase.)

When you scan two or more small items at the same time using the flatbed scanner, you may tick this check box to perform multi-crop automatically. The program will identify each individual item and generate separate scanned image files. The scanned items must be placed separately and no two items are sticking together on the scanner glass. Place all small items on the scanner's flatbed with a slight gap between them for best scanning results.

Auto Deskew

If this box is ticked, the TWAIN program will automatically straighten the skewed image after auto crop is done.

However, if you manually adjust the scan frame, the auto crop is cancelled and therefore the image will not be auto deskewed.



If the placed image is too slanted ($>10^\circ$), the Auto Deskew function will not recognize the skewed image(s).

Auto Rotate

Tick the check box of **Auto Rotate**, the document image you scanned will be automatically rotated and straightened.

Auto Density

Checking this box automatically adjusts the [Histogram](#), to make the scanned image clearer. It does this by increasing the difference between color tones.

Auto Density defines the lightest and darkest pixels in each channel as white and black and then redistributes the intermediate pixel values proportionately. In general, the Auto Density feature gives good results when a simple contrast adjustment is needed to enhance an image with an average distribution of pixel values; however, this feature does not provide the more precise control that can be achieved by adjusting the Histogram controls manually.

Page Settings area, located at the lower part of the Main Settings tab, displays the current settings for image orientation and photo negative effect.

If the current settings don't meet your needs, click the **Configure** button to open a dialog box where you may adjust settings as desired.





On the upper part of the Page Settings dialog box are two viewers. The left viewer shows the original image. The effects for settings you change in this window appear on the right viewer immediately.



Results of rotating and flipping will only appear in the scan result, but not be shown on the prescanned image in the [Preview Window](#).



Rotate

When you click **Rotate** from the menu box on the left, the available options are immediately shown on the right:

-  **No Rotation**-- Clicking this button resets the image to its original orientation.
-  **90° Right**-- Clicking this button turns the image clockwise by 90°.
-  **180°**-- Clicking this button turns the image by 180°.
-  **90° Left**-- Clicking this button turns the image counterclockwise by 90°.

Flip

When you click **Flip** from the menu box on the left, the available options are immediately shown on the right:

-  **Flip Horizontally**-- Each click on this button will flip your image around the central vertical axis to create a mirror image.
-  **Flip Vertically**-- Each click on this button will flip your image around the central horizontal axis to create a mirror image.

Inverse

When you click **Inverse** from the menu box on the left, the available options are immediately shown on the right:



- **Inverse--** Clicking this button will reverse the colors of the entire image. A black and white image will look similar to a photo negative. Inverting a color image will change each pixel to its complementary color.

2.2.2 Advanced Tab

Advanced Tab provides some useful image enhancement tools for you to precisely tailor the image before the final scan. The effects of changes you make are shown in the [Preview Window](#) immediately.

There are 4 tabs at the lower section of Advanced Tab: Gamma, Histogram, HSL and Threshold. These items are intended for users who are familiar with image editing tools and how they affect images. If you are just learning how to scan, then we strongly recommend not using these features until you become familiar with your scanner and its terminology. Many image-editing programs already have these features. However, if the need arises to adjust the color level of your scanned images, then click on the appropriate tab and perform the adjustments. Note: Before adjusting the Gamma, Histogram and/or HSL, perform a [PREVIEW](#) so you can view the changes before you scan.

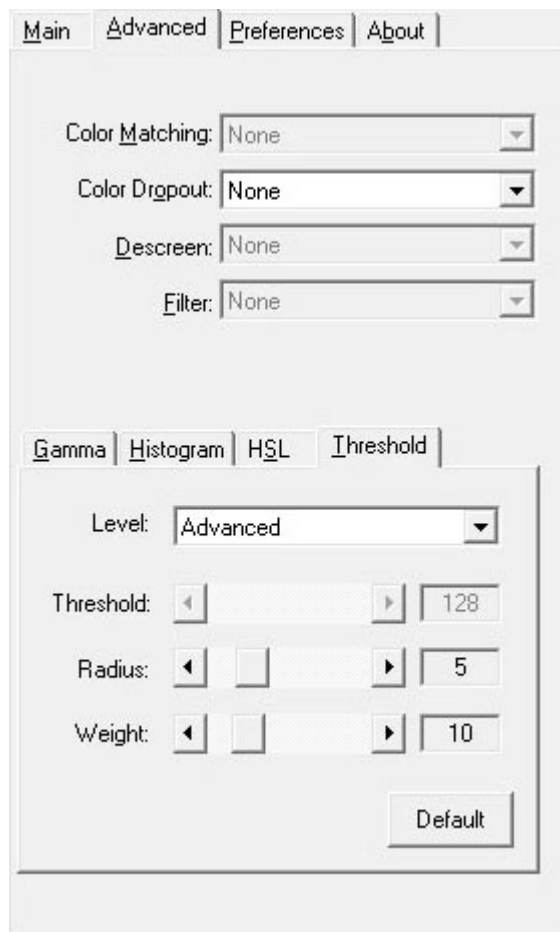

Clicking anywhere on the above screenshot links you immediately to more detailed information of the selected function.

2.2.2.1 Color Matching

Different types of devices reproduce different ranges of colors (or color gamut). For example, you may have noticed the colors of the scanned image displayed on your monitor and on the paper printed from your printer are different.

Color Matching allows you to get consistent color between input and output devices (e.g., scanner, monitor, printer). It works by embedding a color profile to your image files. Each different device displays colors according to this profile and therefore results in consistent color appearance among all devices.

The following options are available from the drop-down list:

- **None**-- Apply no color matching profile.
- **Color sRGB**-- Provides a particular color matching technique to maintain the color consistency between your output and the original images.
- **Custom...**-- Select this option to apply your own ICC (International Color

Consortium) profile.



This feature is available only when **Color** is selected as [Scan Mode](#).

2.2.2.2 Color Dropout

Color Dropout allows you to remove a color channel (Red, Green or Blue) while scanning.

For example, if your original document contains blue texts or a blue stamp (e.g., a bill or invoice) and you want to discard it from your image, you may select **Blue Channel** from the drop-down list.



This feature is available only when **Black & White** or **Grayscale** is selected as [Scan Mode](#).

2.2.2.3 Descreen

Descreen applies filtering to images that contain moiré patterns (or herringbone). A moiré pattern is created from scanning pictures in magazines, or printed material that use color dithering. The descreen filter is not needed when scanning original photographs or black and white images and text, but is recommended when scanning any printed color graphics, such as a page from a magazine, in order to remove the unsightly interference patterns which may occur.



This feature is not available when **Black & White** is selected as [Scan Mode](#).

2.2.2.4 Filter

Filters help you improve your scans by allowing you to sharpen images as well as remove excessive dots and distortion.

The following options are available from the drop-down list:

- **None**-- Applies no filter in the scanned image.
- **Average**-- Determines the medium depth of an image and averages adjacent pixels to make images appear softer.
- **Blur**-- Dulls the edges within an image and decreases the contrast by making dark edges lighter and light edges darker.
- **Blur More**-- Adds additional blurring.
- **Sharpen**-- Allows you to sharpen the edges within an image by making the edges in an image more distinct. The Sharpen filter also increases contrast by making dark edges darker and surrounding light edges lighter.
- **Sharpen More**-- Adds additional sharpening.
- **Unsharpen**-- Sharpens the edges in an image to remove the blurriness.

This setting is not available when **Black & White** is selected as [Scan Mode](#).



The application of a filter can greatly reduce the scanning speed.

2.2.2.5 Gamma

Image Gamma is used to adjust the colors in the image that will be scanned into the computer. Gamma values follow a smooth curve. By adjusting the gamma, you can change the tonal range of the selected color channel. Gamma values are primarily a measure of the brightness of a color. The larger the gamma value, the brighter the color becomes.

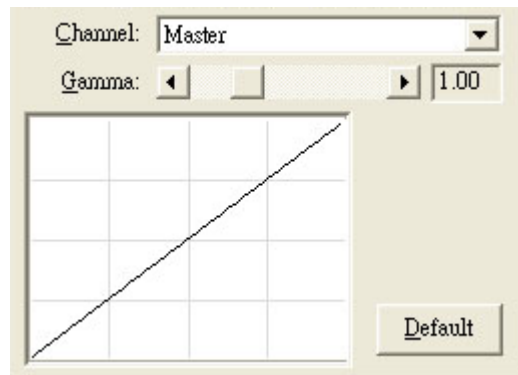

To adjust the image gamma:

1. Select the [channel](#).
2. Slide the thumb of the scroll bar to the right or left, or click the arrow signs on the right and left ends.

The current value is shown to right of the scroll bar.

Gamma

Adjusting the gamma on the Master channel affects the tonal range for all colors equally.

Adjusting the gamma for the individual Red, Green or Blue channels only affects pixels containing that color.

Default

Clicking the Default button on the lower right corner revert the settings to its original values and discard all adjustments you have made.



This feature is not available when **Black & White** is selected as [Scan Mode](#).

2.2.2.6 Histogram

If the colors in a scanned image appear garbled or unclear, the histogram can be used to make them more to your liking. A histogram shows how bright or dark colors in the image are, and can be used to adjust these levels.



When using the histogram, it is very helpful to preview the image. Changes made to the histogram will instantly be shown on the image in [Preview Window](#), allowing you to immediately judge the effects of the changes.

A histogram is a graphic representation of the tonal distribution (the brightness and darkness levels) in an image. It plots the number of pixels (dots) at each brightness level. The histogram displays these levels in 4 different [channels](#).

The x-axis of the histogram graph represents the color values from darkest (0) at the far left to the brightest (255) at the far right; the y-axis represents the total number of pixels at that value. A histogram for a dark image shows most of the pixels at the left side of the graph. A histogram for a bright image is more heavily weighted to the right side.

To adjust the histogram:

1. Select the [channel](#).
2. Slide the thumb of the scroll bar to the right or left, or click the arrow signs on the right and left ends.

The current value is shown to right of the scroll bar.

Highlight:

The highlight represents the high (bright) end of the color spectrum. If the highlight value of the Master channel is lowered to 245, all color values between 245 and 254 will be given the value of 255 (white).

Thus, lowering the highlight of the Master channel brightens the whole picture. Doing this also increases the color contrast because all the remaining pixels between the midtone and the highlight will be automatically redistributed over the midtone to 255 range. This redistribution serves to increase the difference between shades of color.

If the highlight for one of the Red, Green or Blue channels is adjusted then the results will only affect pixels of that color or containing combinations of that color (i.e. Yellow contains Green and Blue and would thus also be affected by

changes to one of these channels).

Shadow:

The shadow represents the low (dark) end of the color spectrum. If the shadow value on the Master channel is raised to 10, all color values between one and ten will be given the value of zero (black). Thus, raising the shadow darkens the entire image and raising the shadow in a specific color channels darkens pixels of that color. Raising the shadow also increases the color contrast of darker tones (the range between the midtone and the shadow).

Default

Clicking the Default button on the lower right corner revert the settings to its original values and discard all adjustments you have made.



- Ticking the [Auto Density](#) checkbox will automatically adjust the histogram to give high quality images without needing to manually adjust the settings in the [Histogram](#) tab.
- This feature is not available when **Black & White** is selected as [Scan Mode](#).

2.2.2.7 HSL

This tab allows you to adjust the colors in an image.

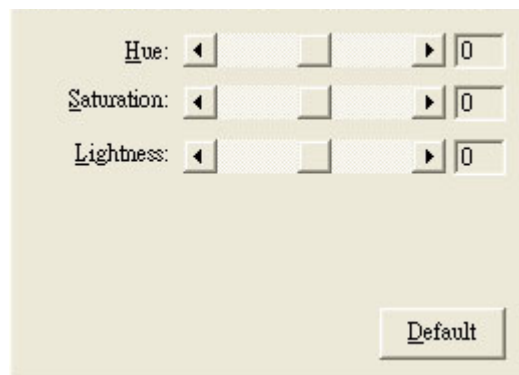

You may adjust Hue, Saturation and Lightness respectively either way:

- Slide the thumb of the scroll bar to the right or left.
- Click the arrow signs on the right and left ends.

The current value is shown to right of each scroll bar.

Hue

Hue is the wavelength of a color. Altering the hue changes the base color of an image.

Saturation

Saturation represents the pureness of a color. Altering the saturation makes the colors more intense or washed out.

Lightness

Lightness defines the amount of white or black in a color. Altering the lightness affects the brightness of the image.

Default

Clicking the Default button on the lower right corner revert the settings to its original values and discard all adjustments you have made.



This feature is available only when **Color** is selected as [Scan Mode](#).

2.2.2.8 Channel

Along the top of the Gamma and Histogram tabs is the Color Channel selection. This can be useful in comparing color ranges between the color values, and in identifying methods when editing specific areas.

If the **Master** channel is selected, your change to the Gamma and Histogram values affect all 3 color channels evenly and keeps them balanced.

If an individual color (**Red**, **Green** or **Blue**) is selected, your change to the Gamma and Histogram values affect pixels containing that color.



Master channel is the only active channel for gray images.

2.2.2.9 Threshold

This setting is available only when **Black & White** is selected as [Scan Mode](#).

Threshold sets the color level for converting an image to line art, which can adjust the quality of line art image or eliminate unwanted dots in the documents to improve OCR accuracy.

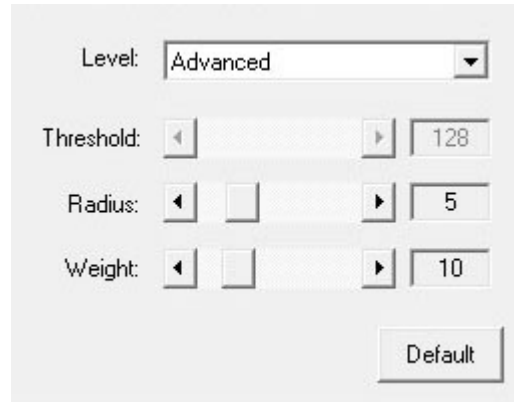

The following options are available from the drop-down list:

- **Basic**

You may adjust the Threshold value either way:

- Slide the thumb of the scroll bar to the right or left to decrease or increase the Threshold value.
- Click the arrow signs on the right and left ends.

The current value is shown to right of the scroll bar.

- **Advanced**

You may adjust the Radius / Weight value either way:

- Slide the thumb of the scroll bar to the right or left to decrease or increase the value.
- Click the arrow signs on the right and left ends.

The current value is shown to right of the scroll bar.

- **Auto**

This option will have TWAIN automatically apply optimal threshold value to your scanned images.

Default

Clicking the Default button on the lower right corner revert the settings to its original values and discard all adjustments you have made.

2.2.3 Preferences Tab

Preferences Tab provides you with additional options to tailor the TWAIN interface to your liking. There is a list at the left section of Preferences Tab shows the following options: General, [Image Enhancement](#), [Multi-image output](#) (This function may or may not be available depending on the scanner model you purchase.), [Image Edge Fill](#), [Remove Punch Holes](#) (This function may or may not be available depending on the scanner model you purchase.), [Scan continuously](#) and [Split](#).

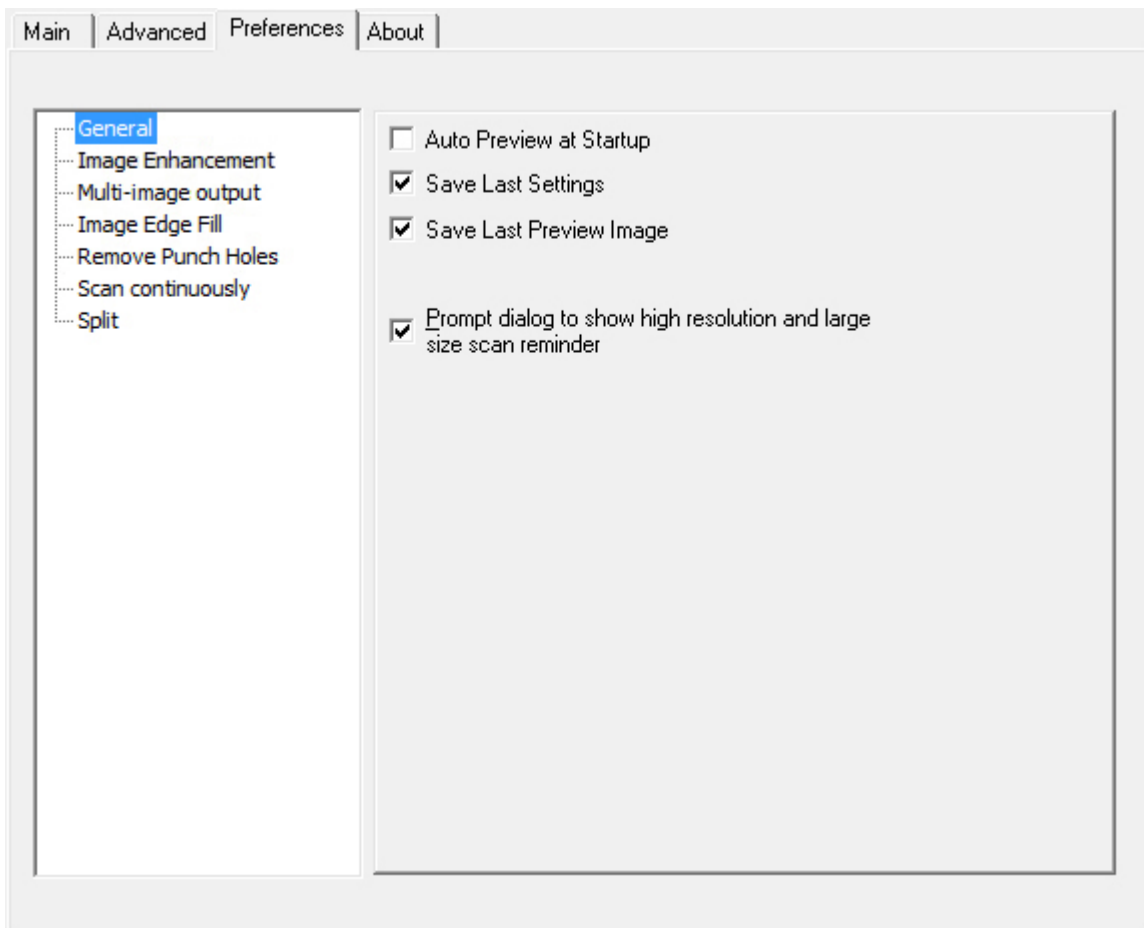

Tick on the checkbox of the item you want to apply to this program.

Clicking anywhere on the above screenshot links you immediately to more detailed information of the selected function.

2.2.3.1 General

2.2.3.1.1 Auto Preview at Startup

If this box is ticked, the TWAIN program will preview the image automatically each time it is launched. You can then adjust settings as necessary according to the preview image.

2.2.3.1.2 Save Last Settings

If the box is ticked, all settings you have configured before the TWAIN program is closed will be saved and automatically displayed next time when the TWAIN program is launched.

2.2.3.1.3 Save Last Preview Image

If the box is ticked, the last preview image before the TWAIN program is closed will be displayed in the Preview Window next time when the TWAIN program is launched.

2.2.3.1.4 Prompt dialog to show high resolution and large size scan reminder

Tick this check box to show a warning dialog when users scan high resolution and large size documents.

2.2.3.2 Image Enhancement

You may set the conditions to enhance the scanned images in this page.

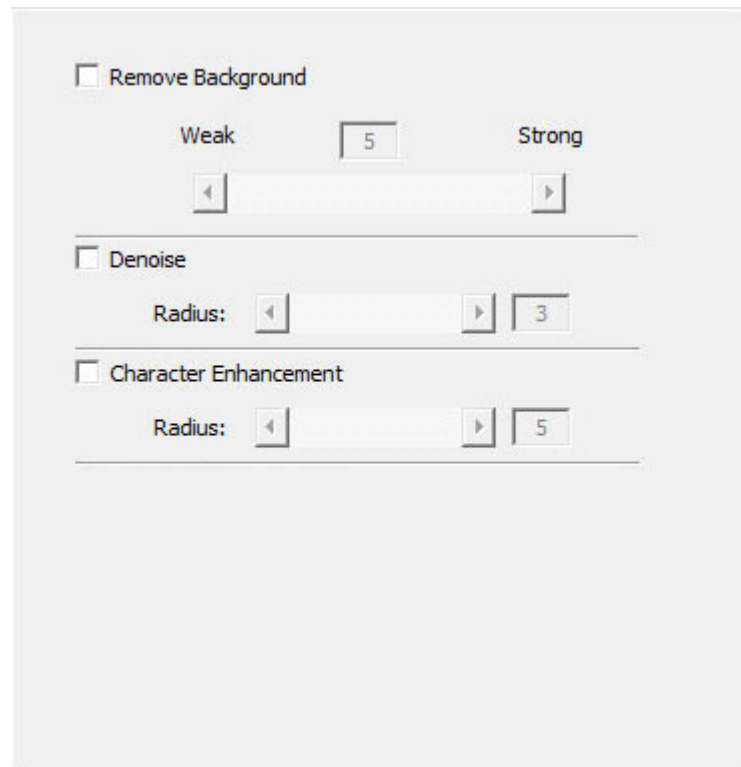

Remove Background

Tick this check box to remove the colored background of the scanned documents. This feature is used to adjust the remove condition of colored background. The higher the value, the greater the effect will be. Slide the thumb of the scroll bar to the right or left, and the current value is shown above the scroll bar.

Denoise

Tick this check box to remove noises from the scanned images. This feature is used to adjust the reduce condition of noises. The higher the value, the more noises will be reduced. Slide the thumb of the scroll bar to the right or left, and the current value is shown to right of the scroll bar.

Character Enhancement

Tick this check box to enhance text characters in the scanned documents. This feature is not available when **Black & White** is selected as Scan Mode. This feature is used to adjust the enhancement value of text characters. The higher the value, the sharper the text character will be. Slide the thumb of the scroll bar to the right or left, and the current value is shown to right of the scroll bar.

2.2.3.3 Multi-image output (This function may or may not be available depending on the scanner model you purchase)

Tick the check box if you want TWAIN to output multiple images after the scan process is finished. Depending on the scan settings, you may choose to output up to three multiple images in **Color**, **Grayscale** and **B/W** by only one scan.

The screenshot shows a dialog box titled "Multi-image output" with a checked checkbox. Below it are two sections: "Front Side" and "Rear Side". Each section contains three rows of settings: "Color", "Gray", and "B/W". Each row has a checkbox, a resolution dropdown menu, and a "dpi" label. In the "Front Side" section, the "Color" checkbox is checked, and its resolution is set to 200 dpi. The "Gray" and "B/W" checkboxes are unchecked, with resolutions of 200 dpi and 300 dpi respectively. In the "Rear Side" section, all checkboxes are unchecked, with resolutions of 200 dpi for Color and Gray, and 300 dpi for B/W.

If you select **Color** as **Scan Mode**, you may tick the check boxes of **Gray** and **B/W** to output color, grayscale and B/W images by only one scan.

If you select **Color** as **Scan Mode**, you may tick the check box of **Gray** to output color and grayscale images by only one scan.

If you select **Gray** as **Scan Mode**, you may tick the check box of **B/W** to output grayscale and B/W images by only one scan.

If you select **B/W** as **Scan Mode**, only B/W image will be generated by one scan.

You may select the desired resolution from the dpi drop-down list. If you select **Custom** from the drop-down list, please set the resolution dpi.

2.2.3.4 Image Edge Fill

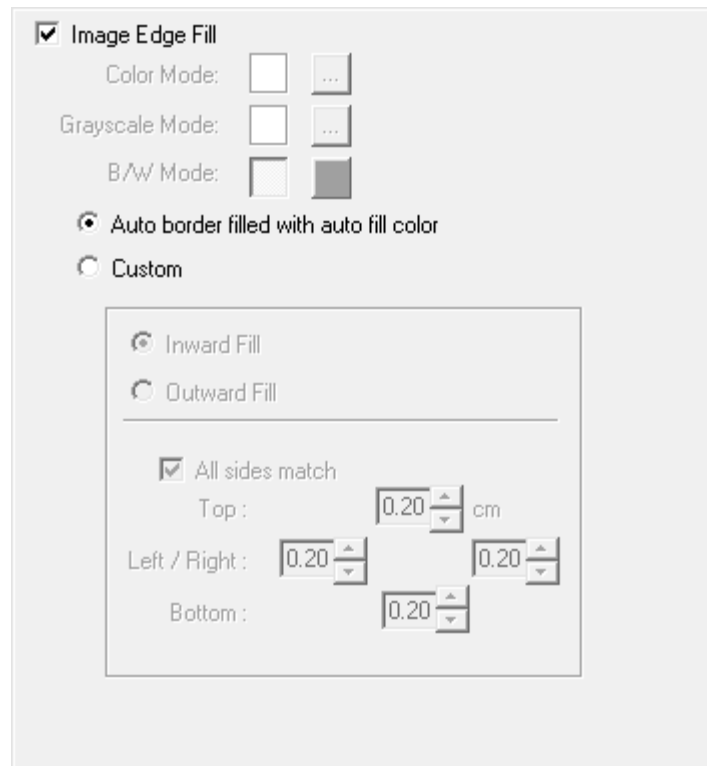

Tick the check box of **Image Edge Fill**, the edge of scanned image would be filled.



Tick the check box of **Image Edge Fill**, the edge of scanned image would be filled.

When you scan by the **Color Mode**, clicking  button would allow you to choose the color you prefer for edge fill.

When you scan by the **Grayscale Mode**, clicking  button would allow you to adjust the color you prefer for edge fill.

When you scan by the **BW mode**, you may click  button for white edge fill or  button for black edge fill.

- **Auto border filled with auto fill color**

When the scanned document size is smaller than the selected page size, select this option to automatically detect the document edge in the scanned image and fill the background color around the document edge after the document is scanned.

- **Custom**

Select this option to configure custom options.

- **Inward Fill:** Select this option to fill the selected color inside the edge of the selected page size.

- **Outward Fill:** Select this option to fill the selected color outside the edge of the selected page size.

Tick the check box of **All sides match**, the widths of four sides would be set to be the same. You may adjust the width by clicking  buttons. If you do not tick this check box, then you can adjust the width of each side individually.

2.2.3.5 Remove Punch Holes (This function may or may not be available depending on the scanner model you purchase)

Tick the check box of **Remove Punch Holes**, the hole marks aligned along with the edge of the scanned document will be removed after auto crop is done. The function will work for the document with single background color.

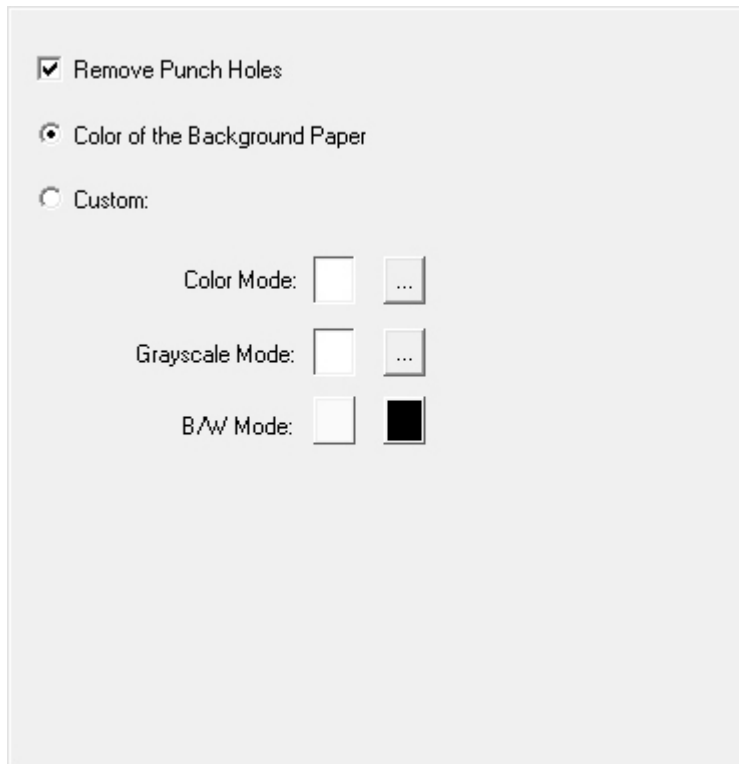

Remove Punch Holes

Color of the Background Paper

Custom:

Color Mode:

Grayscale Mode:

B/W Mode:

Color of the Background Paper



If you select this option, punch hole marks will be filled with the background color of the scanned document.

Custom

If you select this option, punch hole marks will be filled with the selected color.

When you scan by the **Color Mode**, clicking  button would allow you to choose the desired color to remove the punch hole marks.

When you scan by the **Grayscale Mode**, clicking  button would allow you to choose the desired color to remove the punch hole marks.

When you scan by the **B/W Mode**, punch hole marks will be filled with white color if you click  button, or punch hole marks will be filled with black color if you click  button.

2.2.3.6 Scan continuously

Check this option if you want to scan multiple pages successively to the same destination. After the document is scanned, a dialog will pop up asking you if you will put in more paper to continue scanning, or if you want to end the scan.

You may adjust the time interval by clicking  buttons.

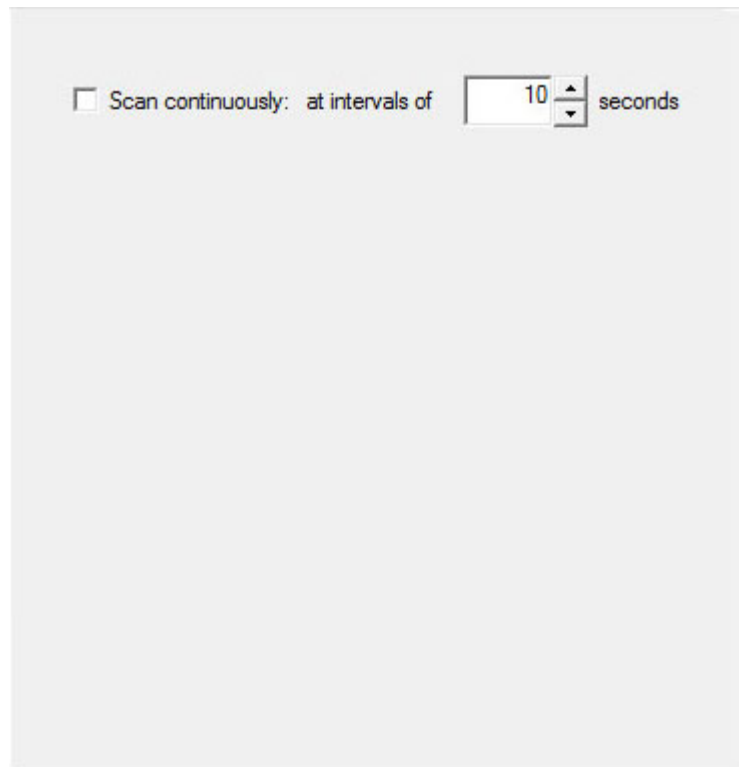

2.2.3.7 Split (This function may or may not be available depending on the scanner model you purchase)

You may set the number by clicking the up or down arrows to split an image into several equal parts. Each equal part can be saved as an image.

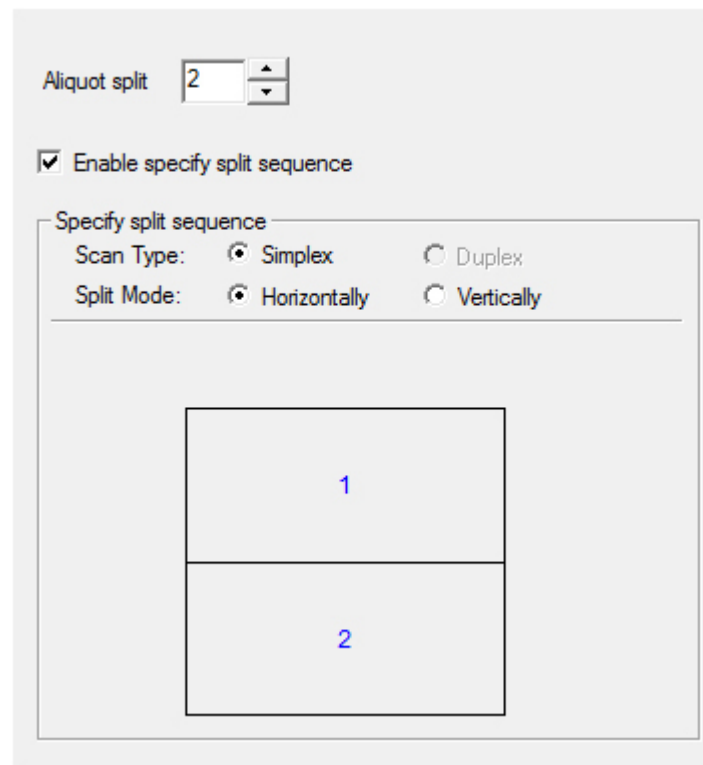

Enable specify split sequence

Tick this check box to specify the image output order of each equal part.

Specify split sequence

Select the options to specify the image output order. You can specify the horizontal and vertical output orders of images scanned in simplex mode. The numbers in the illustration figure show the current image output order of each equal part. To configure the desired output order, clicking on the number to clear the existing output order, and then clicking on each equal part to specify the output order.

2.3 Preview Window

The Preview Window is the large white area on the TWAIN window. Documents or images that are previewed will be displayed here. The previewed image gives you an idea of how a document or image will look after it is scanned.



Following are some important points about the Preview Window:

1. If you change any settings in the TWAIN window, the effects of the changes (except for [Flip](#), [Rotate](#), [Filter](#) and [Descreen](#)) will appear on the previewed image in the Preview Window.
2. The [scan area](#), designated by the dotted box in the Preview Window, can be resized and moved, thus reducing the size and amount of memory used by smaller images.
3. You can use the [Magnifying Glass](#) to zoom the view of the prescanned image by clicking on the magnifying glass button and then clicking on the part of the image you wish to view in detail.

Ruler

Both vertical and horizontal rulers appear on the top and the left sides of the Preview Window. Clicking on the [Unit](#) button on the upper left corner of the Preview Window changes the measurement unit of the ruler.

Unit

This button defines the measurement unit used in the Preview window and [Scan Information](#) Bar. Simply clicking this button to choose your preferred measurement unit: cm (centimeter), in (inch), px (pixel).

2.3.1 Scan Area

It is preferable to scan the exact area of the document or image so the file size is the smallest possible and there are no large blank areas on the page.

The box composed of dotted lines located in the [Preview Window](#) of the TWAIN window defines the scan area. It is the image area that will be included in the final scan.

The Scan Area can be resized and moved.

- Move the pointer (if you have been using the [Magnifying Glass](#) button you need to click on the [Hand Tool](#) button to the left), onto one side of the scan area until the pointer turns into a double-headed arrow. Then, click the left mouse button, and while keeping it pressed, move your mouse. This resizes that side of the scan area. Release the mouse button when you are finished. This procedure can be repeated on all sides of the scan area.
- By moving the pointer into the scan area until it turns into a four-headed arrow you can move the entire scanning area without resizing it.

Reducing the scan area reduces the image size so images take up less memory and less space on your hard drive.

2.3.2 Magnifying Glass

Clicking on the magnifying glass button  changes the cursor to a magnifying glass and lets you easily zoom into the prescanned image in the [Preview Window](#).

Simply place the magnifying glass over the portion of the picture you wish to have a close-up view of and click the left mouse button. You can then view the enlarged detail of the image proportionally. To zoom out, right click the mouse button.

To stop zooming in and out of the image, click on the [Hand Tool](#) button next to the Magnifying Glass.



The magnifying glass only affects the view of the prescanned image in the preview area and does not affect the scanning process or the final scanned image.

In other words, zooming in on an image will not make the scanned image larger. Adjusting the size of an image must be done by scaling it in an image-editing application. Make sure to scan the image at a sufficiently high resolution when planning to enlarge it, so there are enough pixels to maintain image integrity after the scaling process.

2.3.3 Hand Tool

Clicking on the hand tool button changes the cursor to a hand tool , and you may use your mouse pointer to resize or move the scan area within the [Preview Window](#).

| Purpose | Mouse Cursor Shape | How to ... |
|-------------------------|--------------------|--|
| To move the image crop | Four-headed Arrow | Place the mouse pointer in the current crop. Hold down the mouse and move the selected frame to the desired position. |
| To adjust the scan area | Two-headed Arrow | Place the mouse pointer at the edge of any side of the frame. Drag the cursor inward or outward to reduce or expand the frame. |

2.4 Scan Information

X=1.68, Y=2.03, W=12.32, H=11.41 | 60.55 KB

This area contains the following information of the preview image:

- **Scan Area Coordinates (X, Y):** Shows the position of the [scan area](#) border in terms of X and Y coordinates.
- **Scan Area Dimension (W, H):** Shows the exact width and height of the

[scan area](#).

- **Image Size:** Shows the amount of memory used by the image. This information is updated any time you change any [scan settings](#) or adjust the [scan area](#). The larger the image size, the longer it takes to actually scan the image. Larger images, due to their memory requirements, will also take longer for your image-editing applications to process when making any corrections.

2.5 Preview

By clicking on the Preview button, you can scan the source document into the [Preview Window](#) within TWAIN interface. This allows you to modify the [scan area](#) (for smaller images such as photographs) and gives you a rough idea of what the scanned image will look like before you scan.

After you have prescanned a document or photo and it appears in the [Preview Window](#) you can adjust settings (except for [Rotate](#), [Flip](#), [Filter](#) and [Descreen](#)) and immediately view these new settings on the image in the Preview Window so you can judge the effects of the different settings before you finally scan.

2.6 Scan

Clicking on this button accepts all current scanner settings and begins the scanning process.

2.7 Exit

Click on this button to close the TWAIN interface.

3 How to Scan

The following describes how you may use Adobe Photoshop to perform your first scan. When you get familiar with the scanning, you may alternatively use other TWAIN compatible scanning program to do your scanning projects.

Step-by-step instructions for scanning documents and images will be provided in the following section:

- [Step by step procedures](#)

3.1 Step by Step Procedures

1. **Using the Flatbed:**
Open the scanner's document cover. Place the document onto the scanner glass headfirst and face-down. Align the top left corner of the document with the arrow on the reference mark. Gently close the document cover.
2. Click the Windows Start button to launch Adobe Photoshop.
3. Within Adobe Photoshop, click **File > Import > (Your scanner model name)-TWAIN**.
4. In the TWAIN window that opens, select **Flatbed Reflective** as the [Scan Type](#).



If the preview is not automatically performed, you may tick the checkbox of [Auto Preview at Startup](#) within the [Preferences Tab](#) if you want preview automatically starts next time when you open this TWAIN interface again.

5. Adjust the [scan settings](#), especially those on the [Main Tab](#) (e.g., [page size](#), [scan mode](#), [resolution](#)).
6. Click the [Preview](#) button. The scanned image should appear in the [Preview Window](#). To define the margins and crop out sections of the image you don't want scanned, use the mouse to click and drag the corners or sides of the scan area borders. Make adjustments to the preview image if needed.
7. Click on the [Scan](#) button.
8. When the scan finishes, click the [Exit](#) button to close the TWAIN window. The scanned images are displayed in Adobe Photoshop, and you may perform the image editing tasks.

3.1.1 Scan by Profile

If you usually scan images with the same settings, you can complete your job in an efficient way by using the scan profile located on the top section of the TWAIN interface.

1. **Using the Flatbed:**

Open the scanner's document cover. Place the document onto the scanner glass headfirst and face-down. Align the top left corner of the document with the arrow on the reference mark. Gently close the document cover.

2. Click the Windows Start button to launch Adobe Photoshop.
3. Within Adobe Photoshop, click **File > Import > (Your scanner model name)-TWAIN**.
4. In the TWAIN window that opens, select a [profile](#).
5. Click on the [Scan](#) button.
6. When the scan finishes, click the [Exit](#) button to close the TWAIN window. The scanned images are displayed in Adobe Photoshop, and you may perform the image editing tasks.

DocAction Online Help

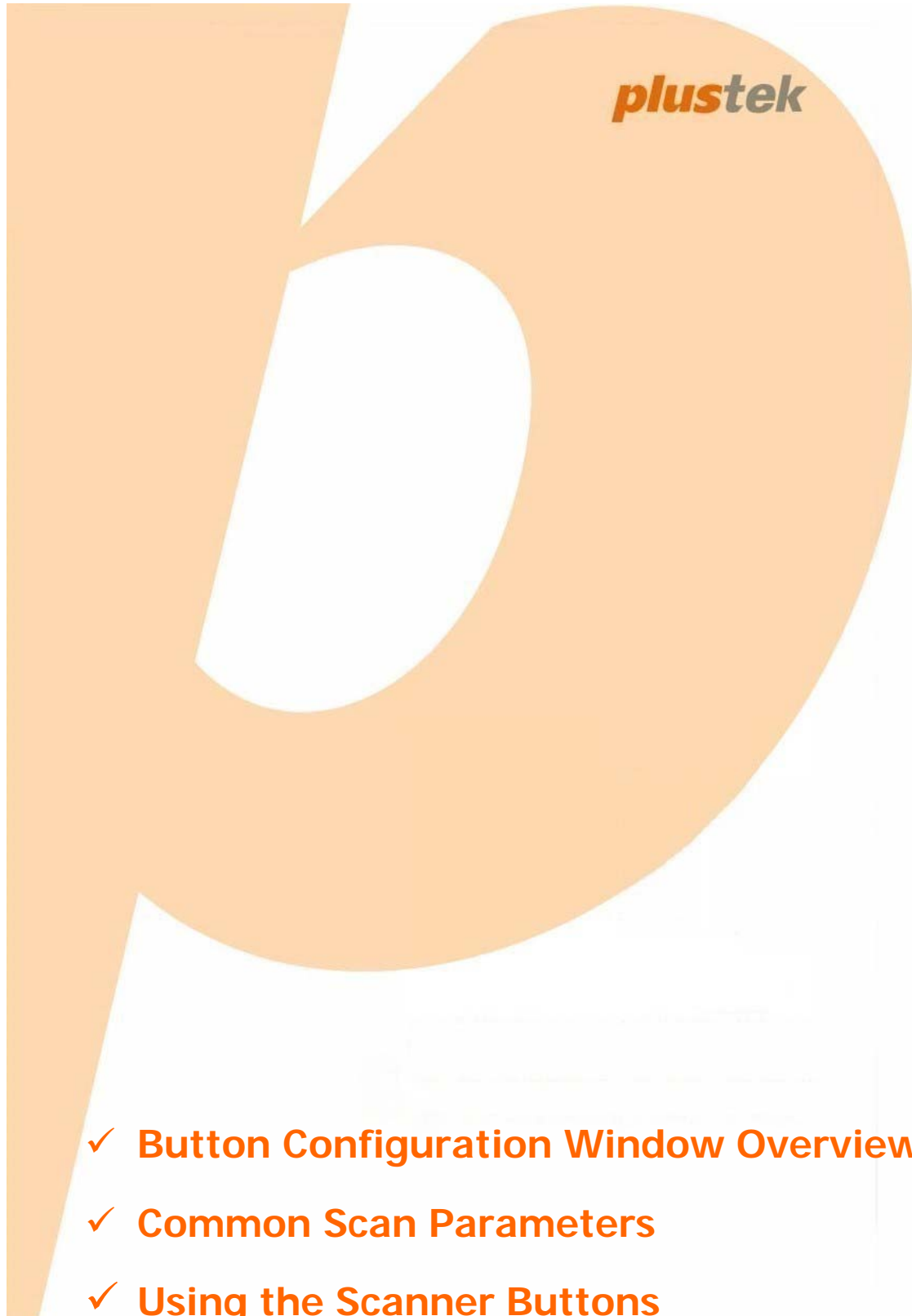

✓ **Button Configuration Window Overview**

✓ **Common Scan Parameters**

✓ **Using the Scanner Buttons**

DocAction: Table of Contents

| | |
|--|-----------|
| Part I Introduction | 2 |
| 1 Operate the Scanner | 2 |
| 2 Button Functions Overview | 3 |
| Part II Button Configuration Window Overview | 5 |
| 1 Customize Button Settings | 5 |
| 2 PDF Button Settings | 6 |
| File Name Setup dialog box (for PDF Button Settings) | 8 |
| File Format Configuration dialog box (for PDF Button Settings) | 11 |
| General (FineReader Configuration)..... | 12 |
| General (Plustek OCR Configuration) | 12 |
| Security | 13 |
| 3 FTP Button Settings | 14 |
| FTP Connection Properties dialog box | 16 |
| Save Setup dialog box (for FTP Button Settings) | 17 |
| 4 E-Mail Button Settings | 19 |
| 5 OCR Button Settings | 22 |
| FineReader OCR Configuration | 24 |
| Plustek OCR Configuration | 26 |
| Save Setup dialog box (for OCR Button Settings) | 27 |
| 6 File Button Settings | 29 |
| File Name Setup dialog box (for File Button Settings) | 32 |
| 7 Copy Button Settings | 34 |
| 8 Scan Button Settings | 36 |
| Add/Modify Linked Application dialog box | 39 |
| Save Setup dialog box (for Scan Button Settings) | 40 |
| 9 Common Scan Parameters | 42 |
| 10 File Format Configuration dialog box | 53 |
| Part III Using the Scanner Buttons | 54 |
| 1 Configure Button Settings | 54 |
| How to Configure Button Settings | 55 |
| 2 Scan from the Buttons | 56 |
| 3 How to create searchable PDF documents by DocAction program? | 57 |

1 Introduction

The DocAction program, seamlessly integrating the operation of your scanner with your computer and other peripherals, provides a quick and convenient way to perform various scanning functions.

With DocAction, you don't need to adjust settings every time you scan. Simply press any button on the scanner's panel or click any scanning menu item of DocAction on the screen. The scanner starts to scan your paper documents and transfer them to your assigned destination. The destination can be a printer, your e-mail program, files on your disk drives, an image-editing program, etc. For example, if you want a printout copy of a purchase order, you may do that in only two steps:

Step 1: Place the paper on the scanner.

Step 2: Press the Copy button on the scanner.

The scanner starts scanning instantly and then sends the image directly to your printer.

DocAction makes this integration and convenience possible at your fingertips.

When DocAction is on, you will see the icon  in your Windows system tray. Right-click on this icon will open a pop-up menu and allow you to:

- [Configure button settings](#). The settings for each single-touch button on the scanner's panel are configured through DocAction.
- Perform predefined scanning tasks in the same way as you press a button on the scanner panel.
- Access Scanner Utility where you may set up the power save mode for the scanning lamp and adjust the initial scanning position.
- View information about this program.

We will guide you through how to configure button settings and how to use scanner buttons to carry out your different scanning tasks. As for the Scanner Utility, please refer to "Chapter III. Care And Maintenance" of the Scanner User's Guide for more

1.1 Operate the Scanner

- Scan from the buttons on the scanner panel

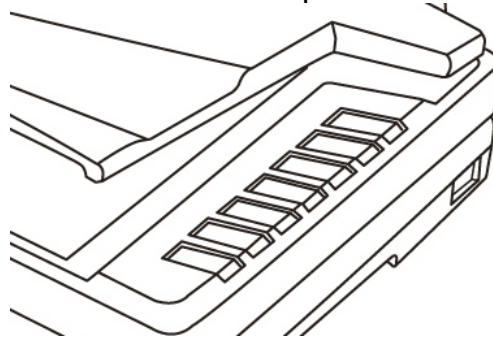

- Scan from DocAction's Execute menu on the screen

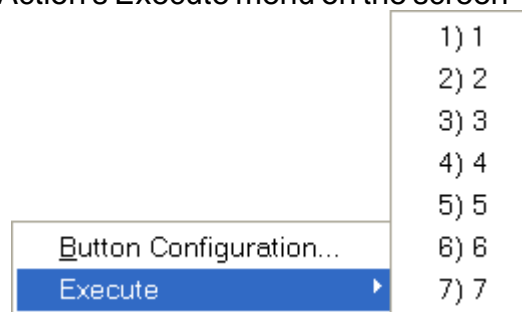

Buttons on the scanner panel will be used in this guide to demonstrate the scanner operations. You may also use DocAction's on-screen Execute menu to perform the same scanning tasks.



In addition to the two fast scanning methods described above, this scanner offers you other ways to scan your paper documents or images. Choose an appropriate scanning method that meets your scanning need and preferences.

- By acquiring images from the scanner through our TWAIN interface within any TWAIN-compliant application programs

For more information, please refer to "Chapter II. Scanning" of the Scanner

1.2 Button Functions Overview

The following button functions are available:

- **OCR--** Scans text documents directly to a text editor or viewer, thus saving you the time usually needed for retyping. It converts the scanned images into an editable text file or a text-searchable pdf file.
- **File--** Scans documents or images and saves them to files. You may determine where they are saved and how their files are named to best meet your needs.

Unlike the Scan button which launches the specified application program after the scan is completed, the File button simply saves the scanned documents or images to files and does not send their image data to any application program, so you don't see the scanning results on screen immediately after the scan. You will find this button useful if you only want to digitize your documents or images and don't want to confirm the scan result right after the scan.



- **Scan--** Scans documents or images to a linked image-editing application programs for viewing or post processing. Alternatively you may set up this button as a hot key to simply launch any application program without scanning action.

Unlike the File button which simply saves the scanned documents or images to files after the scan is completed, the Scan button not only saves the scanned documents or images to files but also transfer them to a specified image-editing program for you to view or check the scan results.



- **Copy--** Scans documents or images directly to the printer without saving them to your hard drive, making it ideal for getting a quick copy of a document or image. DocAction transforms your scanner and printer into a convenient office copier.
- **E-Mail--** Scans documents or images directly to your e-mail program and automatically creates a new message with the image files attached. A copy is automatically saved on your disk drive too.

2 Button Configuration Window Overview

DocAction allows you to tailor each individual scanner button to meet your scanning needs of all time. There are two ways to configure or view the button settings of DocAction:

- Double-click the icon  in the Windows system tray.
- Right-click the icon  in the Windows system tray, and then choose **Button Configuration** in the pop-up menu that opens.

Within the Button Configuration window, you can find a row of icons running through the left side of the window. Each icon corresponds to a single-touch button on your scanner's panel (as well as DocAction's on-screen Execute menu). If not all available buttons are displayed, drag the scrolling bar up and down to navigate through them. Clicking any icon on the left pane and its current button settings are displayed immediately on the right pane. You may adjust the settings as desired.

 If the icon  is not displayed on the system tray, from Windows **Start** menu, point to **All Programs > (your scanner model name)** and then click **DocAction** to reactivate the program. (For Windows 8.1 users: Point your mouse cursor to the upper or lower right corner of your screen to open the **Charm** bar. Click on the **Start** charm, then click on the downwards arrow button in the lower left corner of the screen. The **Apps** screen will be shown. Move your cursor to the right edge of the screen to scroll right until you find **Your scanner model name**, and then click on **DocAction** to reactivate the program.)

2.1 Customize Button Settings

Clicking any icon on the left pane in the Button Configuration window displays its







Button Template

Each available scanning function (Scan, Copy, OCR, File, E-Mail, PDF, FTP) has been especially designed as an individual button template, which gives you great convenience and time-saving in configuring the settings to meet your needs. By simply selecting one function from the drop-down menu, you may turn this Custom button into your frequently-used scanning function.

Description

After you select a desired function from the drop-down menu of Button Template and adjust the corresponding settings in this Button Configuration window, you may enter a brief description here as a personal memo.

Also see:

-  [OCR Button Settings](#)
-  [File Button Settings](#)
-  [Scan Button Settings](#)
-  [Copy Button Settings](#)
-  [E-Mail Button Settings](#)
-  [PDF Button Settings](#)
-  [FTP Button Settings](#)

2.2 PDF Button Settings

Clicking the **PDF** icon on the left pane in the Button Configuration window displays its current button settings on the right pane.

The settings can be categorized into two: [File Saving Settings](#) on the upper part, and [Scan Parameters](#) on the lower part.

The items and parameters available in the window are explained as follows:

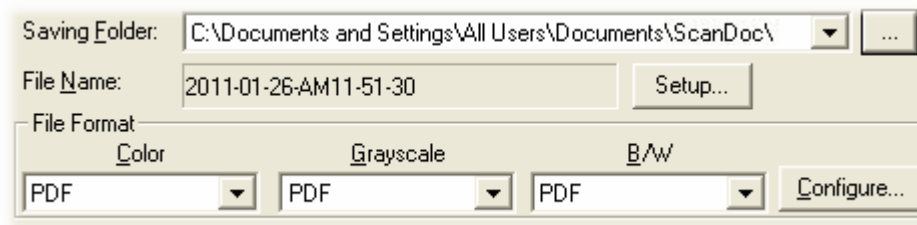

Saving Folder

The scanned documents or images are automatically saved to the folder displayed here.

To select or modify the saving folder, click  to open a dialog box where you may browse your disk drives to select a desired saving folder. **(Open Folder After Scanning:** Tick this check box if you want the program to automatically open the saving folder after scanning.) You can also directly enter the folder name in this field to create a new folder. This newly added saving folder will be added to the drop-down menu. Next time when you want to use this folder again, you may simply click to select it from this drop-down menu.

File Name

Specifies the file name format to save scanned documents or images. The file name extension is automatically added according to the file format you set up.

The current file name format is displayed in the gray rectangle. To change to a different format, click  to open the [File Name Setup](#) window.

File Format

Determines the image file format to save the scanned documents or images to. The following file formats are available from the drop-down list box:

- Searchable PDF
- PDF

Different file formats can be set for different scan modes. You may simply

- [Split](#)
 - [Page Size](#)
 - [Scan Mode](#)
 - [Document Type](#)
 - [Resolution](#)
 - [Brightness](#)
 - [Contrast](#)
 - [Gamma](#)
 - [Threshold](#)
 - [Color Dropout](#)
 - [Descreen](#)
 - [Filter](#)
 - [Page Settings](#)
 - [Continuous Scan](#)
 - [Apply Color Matching](#)
 - [Auto Density](#)
 - [Auto Crop](#)
 - [Multi-Crop](#) (This function may or may not be available depending on the scanner model you purchase.)
 - [Auto Deskew](#)
 - [Image Edge Fill](#)
 - [Multi-image output](#) (This function may or may not be available depending on the scanner model you purchase.)
 - [Remove Punch Holes](#) (This function may or may not be available depending on the scanner model you purchase.)
 - [Remove Background](#)
 - [Denoise](#)
 - [Character Enhancement](#)
 - [Global Settings](#)
 - [Preview](#)
 - [Default](#)
-

2.2.1 File Name Setup dialog box (for PDF Button Settings)

The items and parameters available in the window are explained as follows:

Date and Time

If you choose to name the saved files in Date and Time format, you may use either option as follows:

Use operating system setting

Files are named according to the date and time setting of the operating system of your computer. You may access Control Panel of your operating system to view or permanently modify your current date and time setting.

User-defined

This setting allows you to customize the date and time naming format for your current need. The data and time setting of your operating system remains unchanged.

Custom

The prefix and the numbering scheme are combined to form the file name. Choose this one if you want to have DocAction automatically save scanned images in a consistent naming and numbering pattern.

Prefix

The text you enter here will become the file name prefix.

Numbering Scheme

The successive numeral will be appended at the end of the file name (right after the prefix). This setting allows you to retain the original page numbers of your paper documents on your digitized image files. The numbering scheme consists of the following criteria:

Start with-- Enter the numeral you want to start with.

Pad-- Click the up/down arrow button to select the number of padded zeroes to insert (from 2-9).

clipping_027.jpg" is found to already exist in the destination folder, the newly scanned paper will be saved as "News clipping_027_20130126180032.jpg" in which the numeral 20130126180032 stands for year-month-date-hour-minute-second.

Prompt for confirming file name prefix

Tick the check box to enable the function of **Prompt for confirming file name prefix**. After this function is enabled, the dialog page of **Confirm File Name Prefix** will appear on the screen when you try to scan documents by the **PDF** button of DocAction's Execute Menu. In the page of **Confirm File Name Prefix**, you are able to modify and confirm the saving folder as well as the file name prefix.



Display the dialog after each scan to confirm file name prefix

Tick the check box to display the dialog after each scan to confirm file name prefix. After this function is enabled, the dialog page of **Confirm File Name Prefix** will appear on the screen when you try to scan documents by the **PDF** button of DocAction's Execute Menu. In the page of **Confirm File Name Prefix**, you are able to modify and confirm the saving folder as well as the file name prefix.

Launch designated application after saving file

- Tick this check box and you can click the **Add** button to add the application. The designated application will be launched after the scanned files are saved. For example, if you add an image-editing application, it will appear after scanning. After the scan is complete, this application program is started up automatically and displays all scanned images.
- Clear this check box , the application won't be launched after saving files.

Up to 10 programs can be added to Application's drop-down menu.

- Clicking  opens the "[Add/Modify Linked Application](#)" window where you may add frequently-used programs to the Application menu.
- Clicking  opens the "[Add/Modify Linked Application](#)" window where you modify the name, memo and command line for the current application.
- Clicking  to delete the current application link from the Application

2.2.2 File Format Configuration dialog box (for PDF Button Settings)

Clicking the **PDF** icon on the left pane in the Button Configuration window displays its current button settings on the right pane. Click  in the right pane, which opens this dialog box.

The items and parameters available in the window are explained as follows:

Keep the same image quality level for all modes

Ticking this check box will unify the quality level for all scan modes, thus saving you the trouble of adjusting the quality level individually. If you prefer to manually adjust the image quality level for different modes, leave this check box cleared.

Keep the same TIFF / PDF setting for all modes

Ticking this check box will unify the TIFF / PDF setting for all scan modes, thus saving you the trouble of individually ticking or clearing the TIFF / PDF check box. If you prefer different settings for different scan modes, leave this check box cleared.

Convert to PDF/A (Available for PDF format only)

Tick this box to convert the PDF file format to PDF/A file format for long-term preservation of electronic documents.

Setting

Click the **Setting** button to configure **General** and **Security** settings.

Image Quality

You can set the quality level individually for Color and Grayscale scan modes.

You can adjust the quality value from 1 to 100. The higher the quality setting, the

- Generate one TIFF / PDF file every X pages: save every X pages as a file. You can define the number of pages to be combined in one file.
- Generate one TIFF/ PDF file for scanned pages once a blank page is scanned: generate a new file each time a blank page is encountered. You can use blank pages to split the file.

Auto Mode (This function may or may not be available depending on the scanner model you purchase.)

If PDF or TIFF is chosen as the file format, check this option to merge all the scanned images with the same file format into one file. If TIFF / PDF is chosen as the file format, **Generate one TIFF / PDF file for all pages** option must be selected at the same time to merge all the scanned images into one file.

2.2.2.1 General (FineReader Configuration)

Quality Setting

If PDF is chosen as the file format, you may adjust the image quality either way:

- Slide the thumb of the scroll bar to the right or left.
- Click the arrow signs on the right and left ends.

You can adjust the quality value from 1 to 4. The higher the quality setting, the more detail is preserved, but a larger file size it would take.

Document Language

Select the recognition language to read your pages.

Show All Languages

Tick this box if you want to display all languages in the list.

2.2.2.2 General (Plustek OCR Configuration)

Select the recognition language to read your pages.

Show All Languages

Tick this box if you want to display all languages in the list.

2.2.2.3 Security

The items and parameters available in the window are explained as follows:

Enable Security

Ticking this check box to enable **Encryption Level** and **Passwords** options. If you prefer to save the PDF file without password security, leave this check box cleared.

Encryption Level

The following options are available:

- **Low 40-bit RC4 (Acrobat 3.x, 4.x)**
- **High 128-bit RC4 (Acrobat 5.x and above)**

Passwords

Passwords required to open the document

Ticking this check box to enable **Disallow Users to** options. Enter the desired passwords in the **Password** column.

Password required to change permissions and/or passwords

Ticking this check box to enable **Disallow Users to** options. Enter the desired passwords in the **Password** column.

Disallow Users to

Print the document

Ticking this check box to disallow users to print the document.

Copy texts and images

You may adjust the settings only when you set the **Encryption Level at High 128-bit RC4 (Acrobat 5.x and above)**.

Allow printing in low resolution

Ticking this check box to allow users to print the document in low resolution.

Allow screen readers

Ticking this check box to allow users to read the document on screen.

Allow filling in form fields

Ticking this check box to allow users to fill in the form fields.

Allow changes to the assembly

Ticking this check box to allow users to change the assembly.

After all settings are done, click **OK** button to accept the settings and re-enter the passwords to confirm the settings, or click **Cancel** button to abort your adjustments and exit this window.

2.3 FTP Button Settings

Clicking the **FTP** icon on the left pane in the Button Configuration window displays its current button settings on the right pane.

The settings can be categorized into two: [Session Name and File Saving Settings](#) on the upper part, and [Scan Parameters](#) on the lower part.

The items and parameters available in the window are explained as follows:

Session Name and File Saving Settings

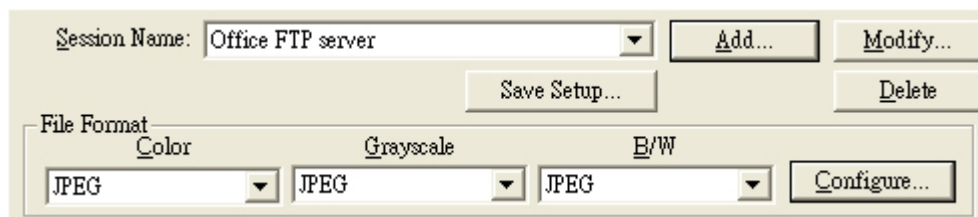

The screenshot shows a dialog box with the following elements:

- Session Name:** A text field containing "Office FTP server" with a dropdown arrow to its right.
- Buttons:** "Add...", "Modify...", "Save Setup...", and "Delete".
- File Format:** A section with three dropdown menus and a "Configure..." button.
 - Color:** A dropdown menu with "JPEG" selected.
 - Grayscale:** A dropdown menu with "JPEG" selected.
 - E/W:** A dropdown menu with "JPEG" selected.

More than one FTP session can be added to the drop-down list.

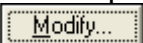
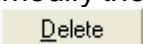
- Clicking  opens the "[FTP Connection Properties](#)" window where you may add frequently-used FTP sessions to the list.
- Clicking  opens the "[FTP Connection Properties](#)" window where you may modify the FTP settings for the current FTP session.
- Clicking  to delete the current FTP session from the list.

Save Setup...

Clicking this button opens the [Save Setup](#) dialog box where you may determine where and in what file name formats the scanned documents or images are saved.

File Format

Determines the image file format to save the scanned documents or images to. The following file format are available from the drop-down list box:



- JPEG: Not available for B/W scan mode.
- TIFF - Uncompressed
- TIFF - Compressed
- PDF
- PNG
- Windows Bitmap

Different file formats can be set for different scan modes. For example, if you usually need color images in JPEG and B/W images in BMP, you may configure so here. Next time when you scan a document in color first and then another document in B/W, you may simply change the [scan parameters](#) without the trouble of changing file formats frequently.

Clicking  opens the [File Format Configuration](#) window where you may configure advanced settings for JPG, TIFF - Compressed and PDF file formats.

- [Brightness](#)
 - [Contrast](#)
 - [Gamma](#)
 - [Threshold](#)
 - [Color Dropout](#)
 - [Descreen](#)
 - [Filter](#)
 - [Page Settings](#)
 - [Continuous Scan](#)
 - [Apply Color Matching](#)
 - [Auto Density](#)
 - [Auto Crop](#)
 - [Multi-Crop](#) (This function may or may not be available depending on the scanner model you purchase.)
 - [Auto Deskew](#)
 - [Image Edge Fill](#)
 - [Multi-image output](#) (This function may or may not be available depending on the scanner model you purchase.)
 - [Remove Punch Holes](#) (This function may or may not be available depending on the scanner model you purchase.)
 - [Remove Background](#)
 - [Denoise](#)
 - [Character Enhancement](#)
 - [Global Settings](#)
 - [Preview](#)
 - [Default](#)
-

2.3.1 FTP Connection Properties dialog box

Clicking the **FTP** icon on the left pane in the Button Configuration window displays its current button settings on the right pane. Click  or  in the

Hostname

Enter the server name or IP address of the FTP server, e.g. ftp.office.com.

Port

Enter the number of Port connections for FTP transfers, e.g. 21.

Remote Directory

Specify a directory on the remote host to determine where the scanned documents or images are saved.

Anonymous Connection

Tick this check box to enable Anonymous connection. Otherwise, you have to enter the **Username** and the **Password** for the FTP connection.

Passive Mode

Tick this check box to enable Passive Mode. This option may be necessary to pass firewalls with connection restrictions.

Delete file after transfer complete

Tick this check box to delete the scan images saved in the specified [Saving Folder](#) after the upload transfer is completed.

2.3.2 Save Setup dialog box (for FTP Button Settings)

Clicking the **FTP** icon on the left pane in the Button Configuration window displays its current button settings on the right pane. Click  in the right pane, which opens this dialog box.

The items and parameters available in the window are explained as follows:

folder again, you may simply click to select it from this drop-down menu.

File Name

You are allowed to name the saved files in two ways:

- using the "Date and Time" format; or
- using customized prefix and numbering scheme.

You can see the file naming example on screen--near the bottom of this dialog box--immediately after you make any adjustments. The file name extension is automatically added according to the file format you set up.

Date and Time

If you choose to name the saved files in Date and Time format, you may use either option as follows:

Use operating system setting

Files are named according to the date and time setting of the operating system of your computer. You may access Control Panel of your operating system to view or permanently modify your current date and time setting.

User-defined

This setting allows you to customize the date and time naming format for your current need. The data and time setting of your operating system remains unchanged.

Custom

The prefix and the numbering scheme are combined to form the file name. Choose this one if you want to have DocAction automatically save scanned images in a consistent naming and numbering pattern.

Prefix

The text you enter here will become the file name prefix.

Numbering Scheme

The successive numeral will be appended at the end of the file name (right

you two options as follows:

- Tick this check box and have DocAction overwrite the existing file with the newly-scanned image.
- Clear this check box and have DocAction not only save the newly-scanned image to file according to your customized prefix and numbering scheme but also append the date and time of your operating system at the end of the file name. For example, if the file "News clipping_027.jpg" is found to already exist in the destination folder, the newly scanned paper will be saved as "News clipping_027_20130126100355.jpg" in which the numeral 20130126100355 stands for year-month-date-hour-minute-second.

Prompt for confirming file name prefix

Tick the check box to enable the function of **Prompt for confirming file name prefix**. After this function is enabled, the dialog page of **Confirm File Name Prefix** will appear on the screen when you try to scan documents by the **FTP** button of DocAction's Execute Menu. In the page of **Confirm File Name Prefix**, you are able to modify and confirm the saving folder as well as the file name prefix.

Display the dialog after each scan to confirm file name prefix

Tick the check box to display the dialog after each scan to confirm file name prefix. After this function is enabled, the dialog page of **Confirm File Name Prefix** will appear on the screen when you try to scan documents by the **FTP** button of DocAction's Execute Menu. In the page of **Confirm File Name Prefix**, you are able to modify and confirm the saving folder as well as the file name prefix.



You are recommended to check existing files in the saving folder before configuring the file name format here, and make sure there are no existing files having the same file name and file extension combination.

2.4 E-Mail Button Settings

File Saving Settings

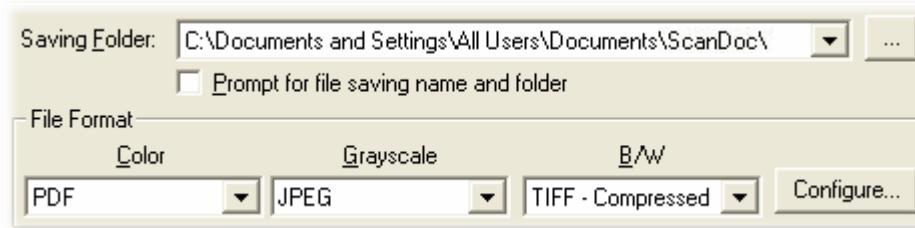

Saving Folder

The scanned documents or images are automatically saved to the folder displayed here.

To select or modify the saving folder, click  to open a dialog box where you may browse your disk drives to select a desired saving folder. You can also directly enter the folder name in this field to create a new folder. This newly added saving folder will be added to the drop-down menu. Next time when you want to use this folder again, you may simply click to select it from this drop-down menu.

DocAction will automatically assign the file name to save the images.

Prompt for file saving name and folder

Tick this check box if you prefer to save each scanned image manually. After the scan of each page finishes, a Save dialog box appears on screen and you may select the folder and file name to save the scanned images individually. This option is useful if you want to save the images scanned in a batch to different folders or in different file naming patterns.

File Format

Determines the image file format to save the scanned documents or images to. The following file formats are available from the drop-down list box:

- JPEG: Not available for B/W scan mode.

another document in B/W, you may simply change the [scan parameters](#) without the trouble of changing file formats frequently.

Clicking  opens the [File Format Configuration](#) window where you may configure advanced settings for JPG, TIFF - Compressed and PDF file formats.

Scan Parameters

- [Scan Type](#)
- [Split](#)
- [Page Size](#)
- [Scan Mode](#)
- [Document Type](#)
- [Resolution](#)
- [Brightness](#)
- [Contrast](#)
- [Gamma](#)
- [Threshold](#)
- [Color Dropout](#)
- [Descreen](#)
- [Filter](#)
- [Page Settings](#)
- [Continuous Scan](#)
- [Apply Color Matching](#)
- [Auto Density](#)
- [Auto Crop](#)
- [Multi-Crop](#) (This function may or may not be available depending on the scanner model you purchase.)
- [Auto Deskew](#)
- [Image Edge Fill](#)
- [Multi-image output](#) (This function may or may not be available depending on the scanner model you purchase.)

2.5 OCR Button Settings

Clicking the **OCR** icon on the left pane in the Button Configuration window displays its current button settings on the right pane.

The settings can be categorized into two: [OCR Settings](#) on the upper part, and [Scan Parameters](#) on the lower part.

The items and parameters available in the window are explained as follows:

OCR Settings

Determine to use which OCR application and what settings (e.g., recognition language, page orientation, ...) to process the scanned images into text file, as well as which word processor to start up and display the OCR'd results.

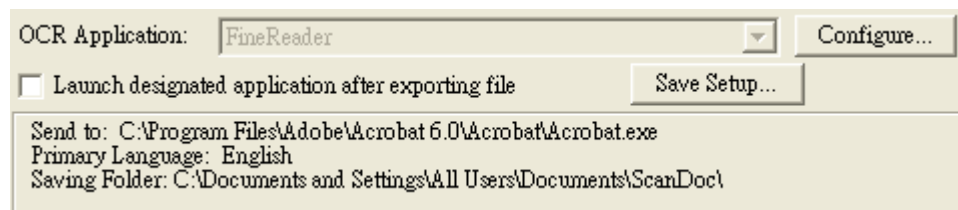

OCR Application

All documents that are scanned are treated by the computer as graphic images. Acting as an image-to-text converter, an OCR (Optical Character Recognition) application program recognizes letters on a page and write them into an editable text file or a text-searchable pdf file. After the scan and

The availability of the programs may vary depending on the scanner model you purchase.

Major OCR settings of the selected OCR application are displayed at the bottom. Clicking  opens a configuration window where you may check or modify the OCR settings (e.g., the file format to save the OCR result, the linked text editor or viewer, recognition language, etc.) as desired.

Launch designated application after exporting file

Ticking this check box allows you to launch designated application after exporting file and save the OCR result of the scanned image(s) after the scan completes.

Save Setup...



Clicking this button opens the [Save Setup](#) dialog box where you may determine where and in what file name format the scanned documents or images are saved.

Scan Parameters

- [Scan Type](#)
- [Split](#)
- [Page Size](#)
- [Scan Mode](#)
- [Document Type](#)
- [Resolution](#)
- [Brightness](#)
- [Contrast](#)
- [Gamma](#)
- [Threshold](#)
- [Color Dropout](#)
- [Descreen](#)
- [Filter](#)

- [Remove Punch Holes](#) (This function may or may not be available depending on the scanner model you purchase.)
 - [Remove Background](#)
 - [Denoise](#)
 - [Character Enhancement](#)
 - [Global Settings](#)
 - [Preview](#)
 - [Default](#)
-

Also see:

-  [FineReader OCR Configuration](#)
-  [Plustek OCR Configuration](#)

2.5.1 FineReader OCR Configuration

If you select FineReader as the OCR application, clicking  opens the FineReader OCR Configuration window. The items and parameters available in this window are explained as follows:

File Format

This setting determines the file format of the OCR'd result. The following options are available from the drop-down menu:

- Plain Text (*.txt)
- Rich Text Format (*.rtf)
- MS Excel Document (*.xlsx)
- Portable Document Format (*.pdf)
- MS Word Document (*.docx)
- Electronic Publication (*.epub)



Some file formats may be unavailable on your screen. The

 to browse to the desired program folder and select the executable file (*.exe) of the desired application program. The application is displayed here with its full file path and execution file name.



Make sure you select an application that can process the specified file format here. OCR'd result cannot be displayed properly if the specified file format is not supported by that application.

Paper Setting

You have two options to save the scanned images:

- **Generate one file for all pages:** save all the scanned images into one file.
- **Generate one file every X pages:** save every X pages as a file. You can define the number of pages to be combined in one file.

Convert to PDF/A

Tick this box to convert the PDF file format to PDF/A file format for long-term preservation of electronic documents.

Quality Setting

If PDF is chosen as the file format, you may adjust the image quality either way:

- Slide the thumb of the scroll bar to the right or left.
- Click the arrow signs on the right and left ends.

You can adjust the quality value from 1 to 4. The higher the quality setting, the more detail is preserved, but a larger file size it would take.

Document Language

Select the recognition language to read your pages.

2.5.2 Plustek OCR Configuration

If you select Plustek OCR as the OCR application, clicking  opens the Plustek OCR Configuration window. The items and parameters available in this window are explained as follows:

File Format



This setting determines the file format of the OCR'd result. The following options are available from the drop-down menu:

- Plain Text (*.txt)
- Rich Text Format (*.rtf)
- MS Excel Document (*.xlsx)
- Portable Document Format (*.pdf)
- MS Word Document (*.docx)
- Electronic Publication (*.epub)



Some file formats may be unavailable on your screen. The availability of file formats depends on what OCR application programs supported by DocAction are installed on your system.

Send to

Select a target application to which you want to send the OCR'd results for viewing and post processing. Click  to have DocAction automatically linked an application that is associated with the file format you specified above. Click  to browse to the desired program folder and select the executable file (*.exe) of the desired application program. The application is displayed here with its full file path and execution file name.



Make sure you select an application that can process the specified

- **Generate one file every X pages:** save every X pages as a file. You can define the number of pages to be combined in one file.

Convert to PDF/A

Tick this box to convert the PDF file format to PDF/A file format for long-term preservation of electronic documents.

Quality Setting

If PDF is chosen as the file format, you may adjust the image quality either way:

- Slide the thumb of the scroll bar to the right or left.
- Click the arrow signs on the right and left ends.

You can adjust the quality value from 1 to 4. The higher the quality setting, the more detail is preserved, but a larger file size it would take.

Document Language

Select the recognition language to read your pages.

Show All Languages

Tick this box if you want to display all languages in the list.

2.5.3 Save Setup dialog box (for OCR Button Settings)

Within the Button Configuration window click the **OCR** icon on the left pane and then click  in the right pane, which opens this dialog box.

The items and parameters available in the window are explained as follows:

saving folder after scanning.) You can also directly enter the folder name in this field to create a new folder. This newly added saving folder will be added to the drop-down menu. Next time when you want to use this folder again, you may simply click to select it from this drop-down menu.

File Name

You are allowed to name the saved files in two ways:

- using the "Date and Time" format; or
- using customized prefix and numbering scheme.

You can see the file naming example on screen--near the bottom of this dialog box--immediately after you make any adjustments. The file name extension is automatically added according to the file format you set up.

Date and Time

If you choose to name the saved files in Date and Time format, you may use either option as follows:

Use operating system setting

Files are named according to the date and time setting of the operating system of your computer. You may access Control Panel of your operating system to view or permanently modify your current date and time setting.

User-defined

This setting allows you to customize the date and time naming format for your current need. The data and time setting of your operating system remains unchanged.

Custom

The prefix and the numbering scheme are combined to form the file name. Choose this one if you want to have DocAction automatically save scanned images in a consistent naming and numbering pattern.

Prefix

The text you enter here will become the file name prefix.

Overwrite the file of the same name

What if a file with the same file name and file extension combination happens to already exist in the assigned saving folder? DocAction offers you two options as follows:

- Tick this check box and have DocAction overwrite the existing file with the newly-scanned image.
- Clear this check box and have DocAction not only save the newly-scanned image to file according to your customized prefix and numbering scheme but also append the date and time of your operating system at the end of the file name. For example, if the file "News clipping_027.jpg" is found to already exist in the destination folder, the newly scanned paper will be saved as "News clipping_027_20130126100355.jpg" in which the numeral 20130126100355 stands for year-month-date-hour-minute-second.

Prompt for confirming file name prefix

Tick the check box to enable the function of **Prompt for confirming file name prefix**. After this function is enabled, the dialog page of **Confirm File Name Prefix** will appear on the screen when you try to scan documents by the **OCR** button of DocAction's Execute Menu. In the page of **Confirm File Name Prefix**, you are able to modify and confirm the saving folder as well as the file name prefix.

Display the dialog after each scan to confirm file name prefix

Tick the check box to display the dialog after each scan to confirm file name prefix. After this function is enabled, the dialog page of **Confirm File Name Prefix** will appear on the screen when you try to scan documents by the **OCR** button of DocAction's Execute Menu. In the page of **Confirm File Name Prefix**, you are able to modify and confirm the saving folder as well as the file name prefix.



You are recommended to check existing files in the saving folder before configuring the file name format here, and make sure there are no existing files having the same file name and file extension combination.

2.6 File Button Settings

and [Scan Parameters](#) on the lower part.

The items and parameters available in the window are explained as follows:

File Saving Settings

Determine how the scanned documents or images are saved to files.

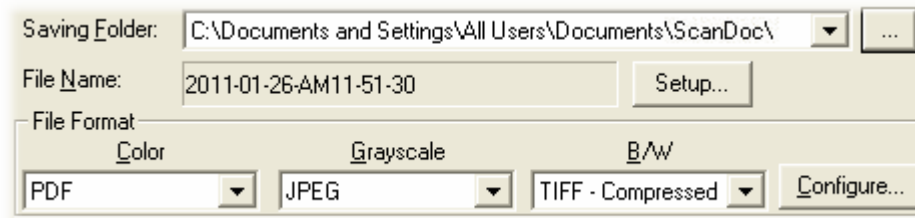

Saving Folder

The scanned documents or images are automatically saved to the folder displayed here.

To select or modify the saving folder, click  to open a dialog box where you may browse your disk drives to select a desired saving folder. (**Open Folder After Scanning:** Tick this check box if you want the program to automatically open the saving folder after scanning.) You can also directly enter the folder name in this field to create a new folder. This newly added saving folder will be added to the drop-down menu. Next time when you want to use this folder again, you may simply click to select it from this drop-down menu.

File Name

Specifies the file name format to save scanned documents or images. The file name extension is automatically added according to the file format you set up.

The current file name format is displayed in the gray rectangle. To change to a different format, click  to open the [File Name Setup](#) window.

- PNG
- Windows Bitmap

Different file formats can be set for different scan modes. For example, if you usually need color images in JPEG and B/W images in BMP, you may configure so here. Next time when you scan a document in color first and then another document in B/W, you may simply change the [scan parameters](#) without the trouble of changing file formats frequently.

Clicking  opens the [File Format Configuration](#) window where you may configure advanced settings for JPG, TIFF - Compressed and PDF file formats.

Scan Parameters

- [Scan Type](#)
- [Split](#)
- [Page Size](#)
- [Scan Mode](#)
- [Document Type](#)
- [Resolution](#)
- [Brightness](#)
- [Contrast](#)
- [Gamma](#)
- [Threshold](#)
- [Color Dropout](#)
- [Descreen](#)
- [Filter](#)
- [Page Settings](#)
- [Continuous Scan](#)
- [Apply Color Matching](#)
- [Auto Density](#)

- [Denoise](#)
 - [Character Enhancement](#)
 - [Global Settings](#)
 - [Preview](#)
 - [Default](#)
-

2.6.1 File Name Setup dialog box (for File Button Settings)

You are allowed to name the saved files in two ways:

- using the "Date and Time" format; or
- using customized prefix and numbering scheme.

You can see the file naming example on screen--near the bottom of this dialog box--immediately after you make any adjustments. The file name extension is automatically added according to the file format you set up.

The items and parameters available in the window are explained as follows:

Date and Time

If you choose to name the saved files in Date and Time format, you may use either option as follows:

Use operating system setting

Files are named according to the date and time setting of the operating system of your computer. You may access Control Panel of your operating system to view or permanently modify your current date and time setting.

Prefix

The text you enter here will become the file name prefix.

Numbering Scheme

The successive numeral will be appended at the end of the file name (right after the prefix). This setting allows you to retain the original page numbers of your paper documents on your digitized image files. The numbering scheme consists of the following criteria:

Start with-- Enter the numeral you want to start with.

Pad-- Click the up/down arrow button to select the number of padded zeroes to insert (from 2-9).

Overwrite the file of the same name

What if a file with the same file name and file extension combination happens to already exist in the assigned saving folder? DocAction offers you two options as follows:



- Tick this check box and have DocAction overwrite the existing file with the newly-scanned image.
- Clear this check box and have DocAction not only save the newly-scanned image to file according to your customized prefix and numbering scheme but also append the date and time of your operating system at the end of the file name. For example, if the file "News clipping_027.jpg" is found to already exist in the destination folder, the newly scanned paper will be saved as "News clipping_027_20130126180032.jpg" in which the numeral 20130126180032 stands for year-month-date-hour-minute-second.

Prompt for confirming file name prefix

Tick the check box to enable the function of **Prompt for confirming file name prefix**. After this function is enabled, the dialog page of **Confirm File Name Prefix** will appear on the screen when you try to scan documents by the **File** button of DocAction's Execute Menu. In the page of **Confirm File Name Prefix**, you are able to modify and confirm the saving folder as well as the file name prefix.

Display the dialog after each scan to confirm file name prefix

appear after scanning. After the scan is complete, this application program is started up automatically and displays all scanned images.

- Clear this check box , the application won't be launched after saving files. Up to 10 programs can be added to Application's drop-down menu.
- Clicking  opens the "[Add/Modify Linked Application](#)" window where you may add frequently-used programs to the Application menu.
- Clicking  opens the "[Add/Modify Linked Application](#)" window where you modify the name, memo and command line for the current application.
- Clicking  to delete the current application link from the Application menu.



You are recommended to check existing files in the saving folder before configuring the file name format here, and make sure there are no existing files having the same file name and file extension combination.

2.7 Copy Button Settings

Clicking the **Copy** icon on the left pane in the Button Configuration window displays its current button settings on the right pane.

The settings can be categorized into two: [Printing Settings](#) on the upper part, and [Scan Parameters](#) on the lower part.

The items and parameters available in the window are explained as follows:

Printing Settings

Because all printers have their own printing characteristics and no two printers will give the exact same output (especially where colors and images are concerned), this Button Configuration window provides a number of options or settings,



Printer

All printers that are currently installed in Windows are displayed in the drop-down menu.

If needed, click  to configure the printer.

Copies

This setting decides the number of copies to be printed. Do one of the following:

- Enter the numeral in the edit box directly; or
- Click  /  to increase/decrease the number.

Center on Page

If the check box is ticked, the image will be centered in the printable area of the selected paper.

Fit to Page

If this option is selected, the print size of the image will be re-scaled to fit within the printable area of the selected paper.

Custom Ratio

This options allows you to re-scale the print size of the image proportionally by doing one of the following:

- Slide the thumb of the scroll bar to the right or left; or
- Click the arrow signs on the right and left ends; or
- Enter the value in the edit box.

Scan Parameters

- [Scan Type](#)
- [Split](#)

- [Filter](#)
 - [Page Settings](#)
 - [Continuous Scan](#)
 - [Apply Color Matching](#)
 - [Auto Density](#)
 - [Auto Crop](#)
 - [Multi-Crop](#) (This function may or may not be available depending on the scanner model you purchase.)
 - [Auto Deskew](#)
 - [Image Edge Fill](#)
 - [Multi-image output](#) (This function may or may not be available depending on the scanner model you purchase.)
 - [Remove Punch Holes](#) (This function may or may not be available depending on the scanner model you purchase.)
 - [Remove Background](#)
 - [Denoise](#)
 - [Character Enhancement](#)
 - [Global Settings](#)
 - [Preview](#)
 - [Default](#)
-

2.8 Scan Button Settings

Clicking the **Scan** icon on the left pane in the Button Configuration window displays its current button settings on the right pane.

The settings can be categorized into two: [Application and File Saving Settings](#) on the upper part, and [Scan Parameters](#) on the lower part.

The items and parameters available in the window are explained as follows:

Application



Specifies an application program to be launched and linked to the Scan button. After the scan is complete, this application program is started up automatically and displays all scanned images.



Make sure you select an application that can process the specified file format. Scanned images cannot be displayed properly if the specified file format is not supported by that application.

For example, if you select file format as JPEG, PNG, BMP or TIFF (compressed or uncompressed), make sure you select an *image-editing* application (e.g., Adobe Photoshop); if you select PDF to save the scanned images, you are recommended to select Adobe Acrobat or Adobe Acrobat Reader that has been installed in your Windows.

Up to 10 programs can be added to Application's drop-down menu.

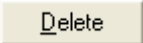
- Clicking  opens the "[Add/Modify Linked Application](#)" window where you may add frequently-used programs to the Application menu.
- Clicking  opens the "[Add/Modify Linked Application](#)" window where you modify the name, memo and command line for the current application.
- Clicking  to delete the current application link from the Application menu.

After you select an application, the program icon will appear as the Scan button icon on the left pane of Button Configuration window.

Launch only

If this check box is ticked, clicking the Scan button will only start the linked application program. No scan is performed.

This option allows you to set up this button as a hot key to simply launch an

Determines the image file format to save the scanned documents or images to. The following file formats are available from the drop-down list box:

- JPEG: Not available for B/W scan mode.
- TIFF - Uncompressed
- TIFF - Compressed
- PDF
- PNG
- Windows Bitmap

Different file formats can be set for different scan modes. For example, if you usually need color images in JPEG and B/W images in BMP, you may configure so here. Next time when you scan a document in color first and then another document in B/W, you may simply change the [scan parameters](#) without the trouble of changing file formats frequently.



Clicking  opens the [File Format Configuration](#) window where you may configure advanced settings for JPG, TIFF - Compressed and PDF file formats.

Scan Parameters

- [Scan Type](#)
- [Split](#)
- [Page Size](#)
- [Scan Mode](#)
- [Document Type](#)
- [Resolution](#)
- [Brightness](#)
- [Contrast](#)
- [Gamma](#)
- [Threshold](#)
- [Color Dropout](#)

- [Image Edge Fill](#)
- [Multi-image output](#) (This function may or may not be available depending on the scanner model you purchase.)
- [Remove Punch Holes](#) (This function may or may not be available depending on the scanner model you purchase.)
- [Remove Background](#)
- [Denoise](#)
- [Character Enhancement](#)
- [Global Settings](#)
- [Preview](#)
- [Default](#)

2.8.1 Add/Modify Linked Application dialog box

Within the Button Configuration window click the **Scan** icon on the left pane and then click  or  in the right pane, which opens this dialog box.

The items and parameters available in the window are explained as follows:

Application

Click  to browse to the desired program folder and select the executable file (*.exe) of the desired application program. The application is displayed here with its full file path and execution file name.

Name

Enter the name for the newly-added application program. The name can be short like a nickname or even in more words including complete software name and its

Command Line

Enter the command line and add %1 at the end of the command line to perform a specific task if you have such information for the selected application program. It is recommended that you leave this field blank if you will not use or are unsure of the command line.

2.8.2 Save Setup dialog box (for Scan Button Settings)

Within the Button Configuration window click the **Scan** icon on the left pane and then click  in the right pane, which opens this dialog box.

The items and parameters available in the window are explained as follows:

Saving Folder

The scanned documents or images are saved to the folder displayed here.

To select or modify the saving folder, click  to open a dialog box where you may browse your disk drives to select a desired saving folder. (**Open Folder After Scanning**: Tick this check box if you want the program to automatically open the saving folder after scanning.) You can also directly enter the folder name in this field to create a new folder. This newly added saving folder will be added to the drop-down menu. Next time when you want to use this folder again, you may simply click to select it from this drop-down menu.

File Name

You are allowed to name the saved files in two ways:

- using the "Date and Time" format; or
- using customized prefix and numbering scheme.

You can see the file naming example on screen--near the bottom of this dialog box--immediately after you make any adjustments. The file name extension is

User-defined

This setting allows you to customize the date and time naming format for your current need. The data and time setting of your operating system remains unchanged.

Custom

The prefix and the numbering scheme are combined to form the file name. Choose this one if you want to have DocAction automatically save scanned images in a consistent naming and numbering pattern.

Prefix

The text you enter here will become the file name prefix.

Numbering Scheme

The successive numeral will be appended at the end of the file name (right after the prefix). This setting allows you to retain the original page numbers of your paper documents on your digitized image files. The numbering scheme consists of the following criteria:

Start with-- Enter the numeral you want to start with.

Pad-- Click the up/down arrow button to select the number of padded zeroes to insert (from 2-9).

Overwrite the file of the same name

What if a file with the same file name and file extension combination happens to already exist in the assigned saving folder? DocAction offers you two options as follows:

- Tick this check box and have DocAction overwrite the existing file with the newly-scanned image.
- Clear this check box and have DocAction not only save the newly-scanned image to file according to your customized prefix and numbering scheme but also append the date and time of your operating system at the end of the file name. For example, if the file "News clipping_027.jpg" is found to already exist in the destination folder, the newly scanned paper will be saved as "News clipping_027_20130126100355.jpg" in which the numeral 20130126100355 stands for year-month-date-hour-minute-second.

Tick the check box to display the dialog after each scan to confirm file name prefix. After this function is enabled, the dialog page of **Confirm File Name Prefix** will appear on the screen when you try to scan documents by the **Scan** button of DocAction's Execute Menu. In the page of **Confirm File Name Prefix**, you are able to modify and confirm the saving folder as well as the file name prefix.



You are recommended to check existing files in the saving folder before configuring the file name format here, and make sure there are no existing files having the same file name and file extension combination.

2.9 Common Scan Parameters

The following describes the scan parameters available to every button setting window:

The screenshot displays a software interface for configuring a scanner. The main area is divided into several sections:

- Scan Type:** A dropdown menu is set to "Flatbed Reflective". Below it are checkboxes for "Merge Pages" (unchecked), "Split" (unchecked), and "Manual Merging Adjustment" (unchecked). At the bottom of this section are radio buttons for "Horizontally" (selected) and "Vertically" (unselected).
- Page Size:** A dropdown menu is set to "Max. Scan Area".
- Scan Mode:** A dropdown menu is set to "Color".
- Document Type:** A dropdown menu is set to "Photo & Text".
- Resolution:** Two dropdown menus, both set to "150".
- Brightness:** A slider control with a value of "15".
- Contrast:** A slider control with a value of "35".
- Gamma:** A slider control with a value of "1.20".
- Threshold:** A dropdown menu set to "Auto" with a ">>" button to its right.
- Color Dropout:** A dropdown menu set to "None".
- Descreen:** A dropdown menu set to "None".
- Filter:** A dropdown menu set to "None".

On the right side, there are two panels:

- Page Settings:** A box containing "Front Side Rotate: 0°" and "Rear Side Rotate: 0°", with a "Configure..." button below.
- Advanced Options:** A list of checkboxes: "Continuous Scan" (unchecked), "Apply Color Matching" (unchecked), "Auto Density" (checked), "Auto Crop" (checked), "Multi-Crop" (unchecked), "Auto Deskew" (unchecked), "Image Edge Fill" (checked), "Multi-image output" (unchecked), "Remove Punch Holes" (unchecked), "Remove Background" (unchecked), "Denoise" (unchecked), and "Character Enhancement" (unchecked).

At the bottom right, there are two buttons: "Preview" and "Default".

Scan Type

Tells the scanner the method you will use to scan documents or images. The following options are available from the drop-down menu:

- **Flatbed Reflective**-- Use this setting to scan normal sheets of paper or any non-transparent material directly from the scanner glass.

Split

Tick the check box of **Split**, a scanned image will be split in two equal halves and each equal half is called a page.

drop-down list, a **Custom Page Size** dialog box opens and you may tailor the page size for documents frequently scanned.

Name:

Give a name to this customized page size. After you configure the page size and click the **OK** button, this name will appear in the **Page Size** drop-down list.

Unit:

Defines the measurement unit for the page size.

Width, Height:

Specifies the exact width and height of the page area.

Paper Alignment:

This setting tells the scanner how you place the document into the scanner.

When **Flatbed Reflective** is selected as the Scan Type:

- **Upper Left:** Place a document face down onto the scanner glass and align the document top with the arrow on the reference mark.
- **Center:** Align the center top of the document with the center of scanner glass's right side.



This setting works well only if you always place the page in the same place on the scanner flatbed.

Scan Mode

Tells the scanner what type of documents you are scanning. The following options are available from the drop-down menu:

- **Black & White**-- scans in black and white and is suitable for scanning text.
- **Grayscale**-- scans in 256 shades of gray, giving black and white images depth and shadow.
- **Color**-- scans in millions of colors (24-bit) but takes up a lot of memory.

enhancement functions are adjusted. This option allows you to customize the image setting parameters for your current needs. If you select this option and don't modify any image setting, the previous image settings will be applied.

- **Default**-- Use this setting to process the scanned document by the default values.
- **Photo**-- Use this setting to process the document contains mostly photographs. This feature is not available when **Black & White** is selected as Scan Mode.
- **Photo & Text**-- Use this setting to process the document contains a mix of graphics and texts.
- **Text**-- Use this setting to process the document contains mostly texts. This setting is available only when **Black & White** is selected as Scan Mode.

Resolution

Resolution is measured in dots per inch (dpi). The higher the resolution, the more detailed the image and the more memory and drive space the image will use.

To conserve computer memory and still receive good image quality, we recommend the following settings.

| Document to be scanned | Resolution (dpi) |
|-------------------------------|------------------|
| Text (for printing) | 300 |
| Text (for faxing) | 200 |
| Text (for OCR) | 300 |
| Black and white or gray image | 150 |
| Color image or photo | 100 |



- These values are only recommendations and should be raised if the resulting image is rough or you need to view fine details.
- To scan a large-size color image with a higher resolution (usually over 600 dpi) increases scan time and file size substantially and requires

You may adjust the brightness either way:

- Slide the thumb of the scroll bar to the right or left, which adds lightness or darkness to all colors in your image.
- Click the arrow signs on the right and left ends.

The current value is shown to right of each scroll bar.

Contrast

The higher the contrast, the sharper the image. The lower the contrast, the more blurry an image will be.

You may adjust the contrast either way:

- Slide the thumb of the scroll bar to the right or left, which raises or lowers the differences between light and dark colors in your image.
- Click the arrow signs on the right and left ends.

The current value is shown to right of each scroll bar.

This feature is not available when **Black & White** is selected as Scan Mode.

Gamma

Image Gamma is used to adjust the colors in the image that will be scanned into the computer. Gamma values are primarily a measure of the brightness of a color. The larger the gamma value, the brighter the color becomes.

Do one of the following:

- Slide the thumb of the scroll bar to the right or left; or
- Click the arrow signs on the right and left ends.

The current value is shown to right of the scroll bar.

This feature is not available when **Black & White** is selected as Scan Mode.

Threshold

Threshold sets the color level for converting an image to line art, which can adjust

Color Dropout

Color Dropout allows you to remove a color channel (Red, Green or Blue) while scanning. This feature is available only when **Black & White** or **Grayscale** is selected as Scan Mode.

For example, if your original document contains blue texts or a blue stamp (e.g., a bill or invoice) and you want to discard it from your image, you may select **Blue Channel** from the drop-down list box

Descreen

Descreen applies filtering to images that contain moiré patterns (or herringbone). A moiré pattern is created from scanning pictures in magazines, or printed material that use color dithering. The descreen filter is not needed when scanning original photographs or black and white images and text, but is recommended when scanning any printed color graphics, such as a page from a magazine, in order to remove the unsightly interference patterns which may occur.

This feature is not available when **Black & White** is selected as Scan Mode.





Filter

Filters help you improve your scans by allowing you to sharpen images as well as remove excessive dots and distortion.

The following options are available from the drop-down list:

- **None**-- Applies no filter in the scanned image.
- **Average**-- Determines the medium depth of an image and averages adjacent pixels to make images appear softer.
- **Blur**-- Dulls the edges within an image and decreases the contrast by making dark edges lighter and light edges darker.
- **Blur More**-- Adds additional blurring.
- **Sharpen**-- Allows you to sharpen the edges within an image by making the edges in an image more distinct. The Sharpen filter also increases contrast by making dark edges darker and surrounding light edges lighter.

Tick the check box of **Auto Rotate**, the document image you scanned will be automatically rotated and straightened.

-  **0°**-- Clicking this button keeps the image at its original orientation.
-  **90° Right**-- Clicking this button turns the image clockwise by 90°.
-  **180°**-- Clicking this button turns the image by 180°.
-  **90° Left**-- Clicking this button turns the image counterclockwise by 90°.

Continuous Scan

Check this option if you want to scan multiple pages successively to the same destination. After the document is scanned, a dialog will pop up asking you if you will put in more paper to continue scanning, or if you want to end the scan.

Apply Color Matching

Different types of devices reproduce different ranges of colors (or color gamut). For example, you may have noticed the colors of the scanned image displayed on your monitor and on the paper printed from your printer are different.

Color Matching allows you to get consistent color between input and output devices (e.g., scanner, monitor, printer). It works by embedding a color profile to your image files. Each different device displays colors according to this profile and therefore results in consistent color appearance among all devices.

Ticking this check box if you want DocAction to apply the built-in color sRGB profile to the scanned images. This feature is available only when **Color** is selected as Scan Mode.

This feature is not available when **Black & White** is selected as Scan Mode.

Auto Crop

Alternatively you may tick this check box to have DocAction automatically identify the dimensions of the image you scanned and crop around the edges. The crop shape will be a square or rectangle and it will not trace the edges of oddly-shaped images. This command can be useful when scanning smaller images such as photographs.

Multi-Crop (This function may or may not be available depending on the scanner model you purchase.)

When you scan two or more small items at the same time using the flatbed scanner, you may tick this check box to perform multi-crop automatically. The program will identify each individual item and generate separate scanned image files. The scanned items must be placed separately and no two items are sticking together on the scanner glass. Place all small items on the scanner's flatbed with a slight gap between them for best scanning results.

Auto Deskew

Tick this check box if you want DocAction to automatically straighten the skewed image after auto crop is done.

If the placed image is too slanted ($>10^\circ$), the Auto Deskew function will not recognize the skewed image(s).

Image Edge Fill

Tick the check box of **Image Edge Fill**, the edge of scanned image would be filled.

Multi-image output (This function may or may not be available depending on the scanner model you purchase.)

Tick the check box if you want DocAction to output multiple images after the scan

Remove Background

Tick this check box to remove the colored background of the scanned documents.

Denoise

Tick this check box to remove noises from the scanned images.

Character Enhancement

Tick this check box to enhance text characters in the scanned documents. This feature is not available when **Black & White** is selected as Scan Mode.

Global Settings

Click the **Global settings** button to configure settings of **Image Enhancement**, **Multi-image output** (This function may or may not be available depending on the scanner model you purchase.), **Image Edge Fill**, **Remove Punch Holes** (This function may or may not be available depending on the scanner model you purchase.), **Scan continuously**, **Split** and **General**.

Image Enhancement

You may set the conditions to enhance the scanned images in this page.

Remove Background

This feature is used to adjust the remove condition of colored background. The higher the value, the greater the effect will be. Slide the thumb of the scroll bar to the right or left, and the current value is shown above the scroll bar.

Denoise

This feature is used to adjust the reduce condition of noises. The higher the value, the more noises will be reduced. Slide the thumb of the scroll bar to the right or left, and the current value is shown to right of the scroll bar.

Character Enhancement

This feature is used to adjust the enhancement value of text characters. The higher the value, the sharper the text character will be. Slide the thumb of the scroll bar to

If you select **Gray** as **Scan Mode**, you may tick the check box of **B/W** to output grayscale and B/W images by only one scan.



If you select **B/W** as **Scan Mode**, only B/W image will be generated by one scan.

You may select the desired resolution from the dpi drop-down list. If you select **Custom** from the drop-down list, please set the resolution dpi.

Image Edge Fill

When you scan by the **Color Mode**, clicking  button would allow you to choose the color you prefer for edge fill.

When you scan by the **Grayscale Mode**, clicking  button would allow you to adjust the color you prefer for edge fill.

When you scan by the **BW mode**, you may click  button for white edge fill or  button for black edge fill.

- **Auto border filled with auto fill color**

When the scanned document size is smaller than the selected page size, select this option to automatically detect the document edge in the scanned image and fill the background color around the document edge after the document is scanned.

- **Custom**

Select this option to configure custom options.



- **Inward Fill:** Select this option to fill the selected color inside the edge of the selected page size.

- **Outward Fill:** Select this option to fill the selected color outside the edge of the selected page size.

Tick the check box of **All sides match**, the widths of four sides would be set to be the same. You may adjust the width by clicking  buttons. If you do not tick

When you scan by the **Color Mode**, clicking  button would allow you to choose the desired color to remove the punch hole marks.

When you scan by the **Grayscale Mode**, clicking  button would allow you to choose the desired color to remove the punch hole marks.

When you scan by the **B/W Mode**, punch hole marks will be filled with white color if you click  button, or punch hole marks will be filled with black color if you click  button.

Scan continuously

You may adjust the time interval by clicking  buttons.

Split

You may set the number by clicking the up or down arrows to split an image into several equal parts. Each equal part can be saved as an image.

Enable specify split sequence

Tick this check box to specify the image output order of each equal part.

Specify split sequence

Select the options to specify the image output order. You can specify the horizontal and vertical output orders of images scanned in simplex mode. The numbers in the illustration figure show the current image output order of each equal part. To configure the desired output order, clicking on the number to clear the existing output order, and then clicking on each equal part to specify the output order.

Prompt dialog to show high resolution and large size scan reminder

Tick this check box to show a warning dialog when users scan high resolution and large size documents.

Preview

By clicking on the Preview button, you can scan the source document into the preview window within DocAction interface. Documents or images that are

2.10 File Format Configuration dialog box

Within the Button Configuration window click the **File**, **Scan**, **FTP** or **E-Mail** icon on the left pane and then click  in the right pane, which opens this dialog box.

The items and parameters available in the window are explained as follows:

Keep the same image quality level for all modes

Ticking this check box will unify the quality level for all scan modes, thus saving you the trouble of adjusting the quality level individually. If you prefer to manually adjust the image quality level for different modes, leave this check box cleared.

Keep the same TIFF / PDF setting for all modes

Ticking this check box will unify the TIFF / PDF setting for all scan modes, thus saving you the trouble of individually ticking or clearing the TIFF / PDF check box. If you prefer different settings for different scan modes, leave this check box cleared.

Convert to PDF/A (Available for PDF format only)

Tick this box to convert the PDF file format to PDF/A file format for long-term preservation of electronic documents.

Image Quality

For *JPEG* and *TIFF-Compressed* file formats, you can set the quality level individually for Color and Grayscale scan modes.

You can adjust the quality value from 1 to 100. The higher the quality setting, the more detail is preserved, but a larger file size it would take. The smaller the image file, the lower quality the image has, but the less disk space it takes. The balance

You can define the number of pages to be combined in a file.

- Generate one TIFF/ PDF file for scanned pages once a blank page is scanned: generate a new file each time a blank page is encountered. You can use blank pages to split the file.

Auto Mode (This function may or may not be available depending on the scanner model you purchase.)

If PDF or TIFF is chosen as the file format, check this option to merge all the scanned images with the same file format into one file. If TIFF/ PDF is chosen as the file format, **Generate one TIFF / PDF file for all pages** option must be selected at the same time to merge all the scanned images into one file.

3 Using the Scanner Buttons

Conditions for buttons to work properly





The following conditions are required for the scanner buttons and DocAction to work properly.

- **OCR:** The OCR application program provided on our scanner CD-ROM must be installed on your computer.
- **Scan:** An application program must be selected to link with the Scan button.
- **Copy:** A printer must be connected and the printer driver has been correctly installed in Windows.
- **E-Mail:** A MAPI-compliant mail program must be installed on your computer.
- **PDF:** The OCR application program provided on our scanner CD-ROM must be installed on your computer.
- **FTP:** A FTP server must be correctly configured to connect with your scanner and your computer.

3.1 Configure Button Settings

3.1.1 How to Configure Button Settings

Within the "Button Configuration" window, you can find a row of icons running through the left side of the window. Each icon represents a scanning task, and the number underneath corresponds to the function number displayed on the scanner panel. Seven frequently-used scanning tasks are pre-configured for your convenience to start scanning immediately. You may, however, customize the settings of every seven tasks to best meet your needs and preferences.

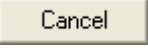
1. Do one of the following to open the Button Configuration window:
 - Double-click the icon  in the Windows system tray.
 - Right-click the icon  in the Windows system tray, and then choose **Button Configuration** in the pop-up menu that opens.
2. When the Button Configuration window appears, click any icon in the left pane.
3. Select the desired function from the drop-down list of Button Template.
4. Enter your personal memo in the Description field.
5. Adjust particular settings related to that button function.
6. Check the [scan settings](#) and make any required changes.
7. After all settings are done, click  to accept the settings and exit this Button Configuration window, or click  to save what you have configured and continue adjusting other settings, or click  to abort your adjustments and exit this window.

Also see:

-  [OCR Button Settings](#)
-  [File Button Settings](#)

3.2 Scan from the Buttons

Scanning documents or images from this scanner is very easy. Follow the two steps described below:

1. Place the document or images onto the scanner. (Refer to the Scanner User's Guide for more information in placing paper on the flatbed glass properly.)



Place only *text documents* for OCR purposes. Do not scan a photo using the OCR button.

2. Do one of the following to start scanning:
 - Press the button from the scanner's panel.
 - Right-click the icon  in the Windows system tray, and then choose **Execute** in the pop-up menu that opens. Click the desired button function item in the pop-up menu.

The scanner starts to scan immediately and carry out the corresponding action according to settings you have set up in the Button Configuration window.



When you scan and upload large amount files to the FTP server, you will see the icon  in your Windows system tray. Right-click on this icon will open a pop-up menu and allow you to:

- View the file transferring status by clicking **Open** from the pop-up menu.
- Terminate the file transfer during the uploading process by clicking **Close** from the pop-up menu.



Also see:

 [Configure Button Settings](#)

3.3 How to create searchable PDF documents by DocAction program?

Scan from the PDF Button

1. Do one of the following to open the Button Configuration window:



- Double-click the icon  in the Windows system tray.
- Right-click the icon  in the Windows system tray, and then choose **Button Configuration...** in the pop-up menu that opens.

2. When the Button Configuration window appears, click any button on the left pane. Select PDF Utility from the drop-down list of Button Template. Enter your personal memo in the Description field.

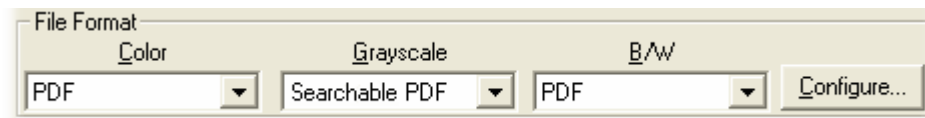
3. Select Searchable PDF from the drop-down list of File Format (Color, Grayscale, B/W).



4. Check the scan settings and make any required changes.

5. After all settings are done, click  to accept the settings and exit this Button Configuration window, or click  to save what you have configured and continue adjusting other settings.

6. Right-click the icon  in the Windows system tray, and then choose **Execute** in the pop-up menu that opens.

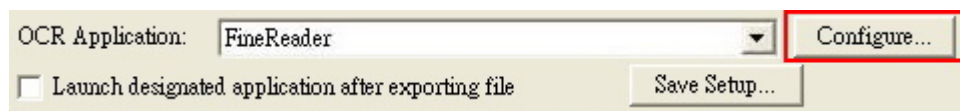

7. Click the configured PDF button function in the pop-up menu.

2. When the Button Configuration window appears, click any button on the left pane. Select OCR Utility from the drop-down list of Button Template. Enter your personal memo in the Description field.
3. Select an OCR application to convert the scanned images into characters readable by your word processor or text viewer. The availability of the programs may vary depending on the scanner model you purchase.
4. Clicking  opens a configuration window for the selected OCR application.

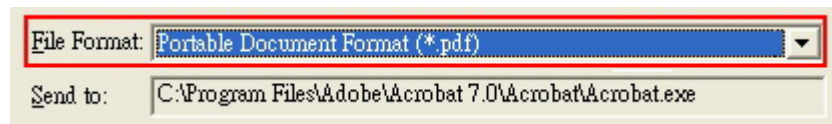

5. Select Portable Document Format (*.pdf) from the drop-down list of File Format.



6. Check the scan settings and make any required changes.
7. After all settings are done, click  to accept the settings and exit this Button Configuration window, or click  to save what you have configured and continue adjusting other settings.
8. Right-click the icon  in the Windows system tray, and then choose **Execute** in the pop-up menu that opens.
9. Click the configured OCR button function in the pop-up menu.

Scanner Utility Online Help

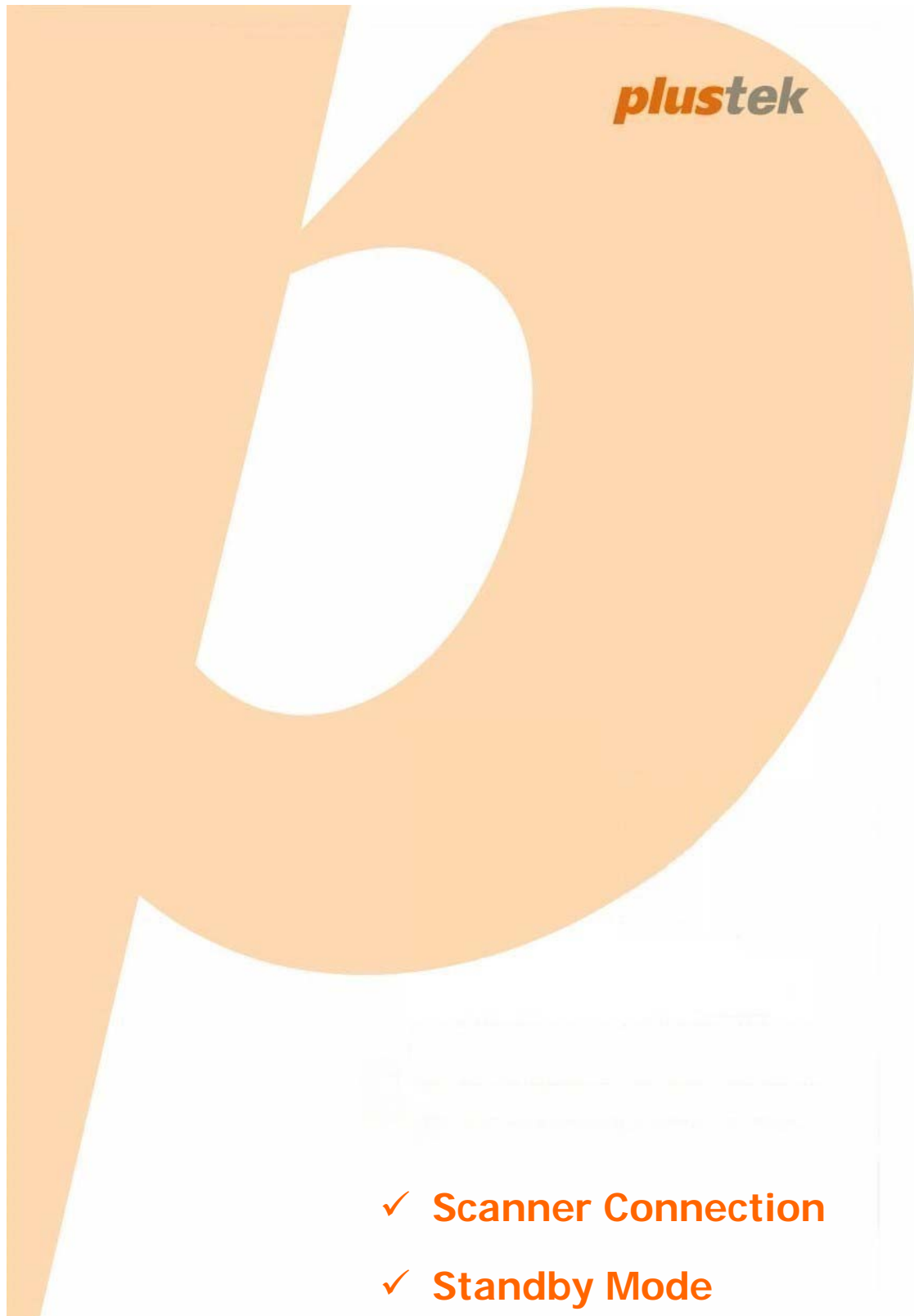

Scanner Utility: Table of Contents

| | |
|---|----------|
| Part I Introduction | 2 |
| Part II Scanner Connection | 3 |
| Part III Aligning the Scanner | 3 |
| Part IV Power Save (This function may or may not be available depending on the scanner model you purchase) | 4 |
| Part V Lamp Control (This function may or may not be available depending on the scanner model you purchase) | 5 |
| Part VI Standby Mode (This function may or may not be available depending on the scanner model you purchase) | 6 |
| Part VII Calibrating the Scanner (This function may or may not be available depending on the scanner model you purchase) | 7 |
| Part VIII Counter Utility (This function may or may not be available depending on the scanner model you purchase) | 7 |
| Part IX Help | 8 |
| Part X Cancel | 8 |

1 Introduction

The main functions of Scanner Utility are: [scanner connection](#) checking, [scanning position alignment](#), [power save](#) (This function may or may not be available depending on the scanner model you purchase), [scanning lamp control](#) (This function may or may not be available depending on the scanner model you purchase), [standby mode](#) (This function may or may not be available depending on the scanner model you purchase), [calibrating the scanner](#) (This function may or may not be available depending on the scanner model you purchase) and [Counter Utility](#) (This function may or may not be available depending on the scanner model you purchase).

The Scanner Utility program checks to make sure that the scanner software is properly installed, and the connection between the scanner and computer is working.

Although we have designed the scanner lock to hold the scanning lamp in place during shipping, sometimes the refinement of the initial scanning position might be necessary.

Furthermore, the program allows you to turn the scanning lamp on and off, define an idle time for the scanning lamp to automatically turn itself off, and set the scanner to automatically perform calibration (This function may or may not be available depending on the scanner model you purchase).

The program allows you to disable the standby mode, or define an idle time for the scanner to automatically enter the standby mode (This function may or may not be available depending on the scanner model you purchase).

The **Counter Utility** automatically counts the number of sheets scanned by your scanner (This function may or may not be available depending on the scanner model you purchase).

2 Scanner Connection

The icon , located on the Windows system tray, indicates if the scanner software is properly launched and the scanner and computer are communicating with each other.



The program has been successfully launched and the scanner is connected with the computer, ready to scan images.



The scanner is not connected with the computer. Or, the scanner power is not switched on. Or, the scanner is in standby mode.

No Display

You have chosen to terminate the program, no matter the scanner is connected or disconnected with the computer.



If the icon is not displayed on the system tray, from Windows **Start** menu, point to **All Programs > (your scanner**

model name) and then click  to reactivate the program. (For Windows 8.1 users: Point your mouse cursor to the upper or lower right corner of your screen to open the **Charm** bar. Click on the **Start** charm, then click on the downwards arrow button in the lower left corner of the screen. The **Apps** screen will be shown. Move your cursor to the right edge of the screen to scroll right until you find **Your scanner model name**, and then click on **DocAction** to reactivate the program.)

3 Aligning the Scanner

heading of a document might be missing from the top edge after the document has been scanned.

1. Place a document face down onto the scanner glass and align the top left corner of the document with the arrow on the reference mark.
2. Right click the icon  on the Windows system tray and select **Scanner Utility** from the menu that pops up.
3. The Scanner Utility window opens. Find the **Initial Scanning Position Alignment** section and select **Flatbed Reflective** as the scan source.
4. Click on the **Scan** button. Part of the document image will be displayed in the Alignment Window.
5. Click on the **Alignment Position** buttons (Up, Down, Left, Right) until the top left corner of the scanned document aligns with the top left corner of the preview window.
6. When the alignment completes, click on **OK** button to save settings and exit.

4 Power Save (This function may or may not be available depending on the scanner model you purchase)

You may opt to keep the scanner lamp always on or define an idle time for the scanning lamp to automatically turn itself off.

1. Right click the icon  on the Windows system tray and select **Scanner Utility** from the menu that pops up.
2. In the **Power Save Mode** section of the Scanner Utility window that opens, click the button of your option:



- To completely shut down the scanner, press the power switch on the side of the scanner.
- If the scanner will not be used for a long period of time, shut down the scanner and then disconnect the power cable from the power outlet.

Alternatively you may click **Default** to restore the default settings. To turn on the lamp again, simply perform any scanning task.

5 Lamp Control (This function may or may not be available depending on the scanner model you purchase)

You may opt to keep the scanner lamp always on or define an idle time for the scanning lamp to automatically turn itself off.

1. Right click the icon  on the Windows system tray and select **Scanner Utility** from the menu that pops up.
2. In the **Lamp Control** section of the Scanner Utility window that opens, click the button of your option:
 - a. To set the lamp being always illuminated: Click the button before **Keep lamp always on**.
 - b. To automatically turn the lamp off: Click the button before **Sleep** and then click the up or down arrows to set a default time for the lamp to automatically turn off after a scan.
3. Click on **OK** button to save settings and exit.

Alternatively you may click **Default** to restore the default settings. To turn on the lamp again, simply perform any scanning task.

6 Standby Mode (This function may or may not be available depending on the scanner model you purchase)

To save power consumption, the scanner will enter the standby mode after it is idle for a while. You may disable the standby mode or define an idle time for the scanner to automatically enter the standby mode.

1. Right click the icon  on the Windows system tray and select **Scanner Utility** from the menu that pops up.
2. In the **Standby Mode** section of the Scanner Utility window that opens, click the button of your option:
 - a. To disable the Standby Mode: Click the button before **Disable Standby Mode**.
 - b. To automatically enter the Standby Mode (Sleep): Click the button before **Sleep** and then click the up or down arrows to set a default time for the scanner to automatically enter the Standby Mode.
3. Click on **OK** button to save settings and exit.



- To completely shut down the scanner, press the power switch on the side of the scanner.
- If the scanner will not be used for a long period of time, shut down the scanner and then disconnect the power cable from the power outlet.

7 Calibrating the Scanner (This function may or may not be available depending on the scanner model you purchase)

Calibrate the scanner if colors appear in areas that should be white, or colors of the scanned image and the original vary a lot. This allows you to adjust and compensate for variations that can occur in the optical component over time by its nature.



1. Right click the icon  on the Windows system tray and select **Scanner Utility** from the menu that pops up.
2. The Scanner Utility window opens. Find the **Calibration Settings** section and select **Flatbed Reflective** as the scan source. Click the button of your option:
 - a. Set the scanner to perform calibration before a scan only if the scan setting "Scan Mode" or "Resolution" is modified: Click the button before **Perform calibration before scanning if the scan mode or resolution is changed**.
 - b. Set the scanner to perform calibration before a scan: Click the button before **Always perform calibration before scanning**.
 - c. Set the scanner to automatically perform calibration: Click the button before **Perform calibration every ... minutes** and then click the up or down arrows to set a default time for the scanner to automatically perform calibration.
3. Click on **OK** button to save settings and exit.

Alternatively you may click **Default** to restore the default settings.

8 Counter Utility (This function may or may not be available depending on the scanner model you purchase)

2. **Target value to replace consumables:** Displays the suggestion value to replace the consumable.
3. **Status:** Displays the usage condition of the consumable parts.
4. Click on **OK** button to save settings and exit.

9 Help

Clicking on **Help** runs this on-line help program.

10 Cancel

Clicking on **Cancel** closes this Scanner Utility program.



Scanner User's Guide

OpticPro

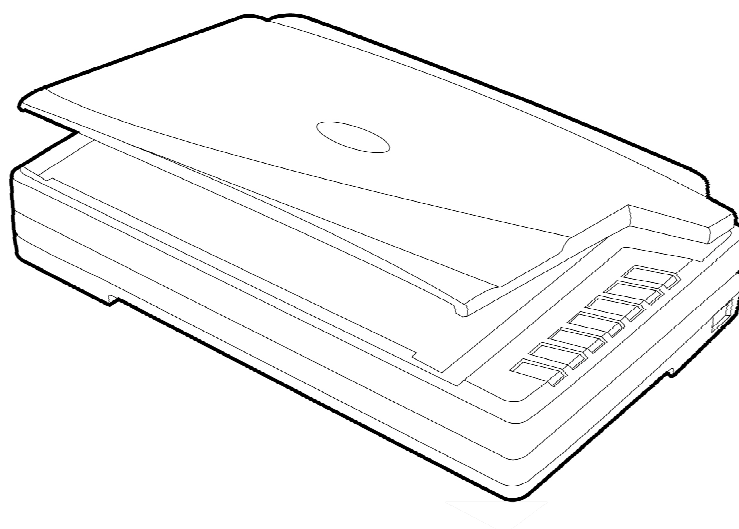

Trademarks

© 2021 Plustek Inc. All rights are reserved. No portion of this document may be reproduced without permission.

Plustek is a registered trademark of Plustek Inc. OCR processing by ABBYY® FineReader®, © 2021 ABBYY. ABBYY and FineReader are trademarks of ABBYY Software, Ltd. which may be registered in some jurisdictions.

All trademarks and brand names mentioned in this publication are property of their respective owners.

Liability

While all efforts have been made to ensure the accuracy of all contents in this manual, we assume no liability for errors or omissions or by statements of any kind in this manual, whether such errors are omissions or statements resulting from negligence, accidents, or any other cause. The contents of this manual are subject to change without notice. We will not shoulder any legal liability, if users failed to follow the operation instructions in this manual.

Copyright

The scanning of certain documents, for example checks, bank notes, I.D. cards, government bonds, or public documents, may be prohibited by law and/or subject to criminal prosecution. We recommend you to be responsible and respectful of the copyrights laws when you are scanning books, magazines, journals and other materials.

Environmental Information

Recycle or disposal at end-of-life information, please ask local distributors or suppliers for recycle and disposal information. The product is designed and produced to achieve sustainable environmental improvement. We strive to produce products in compliance with global environmental standards. Please consult your local authorities for proper disposal.

The product packaging is recyclable.

Attention for recycling (For EU country only)

Protect your environment! This product should not be thrown into the household waste container. Please give it to the free collecting center in your community.

Table of Contents

| | |
|--|-----------|
| INTRODUCTION | 1 |
| How to Use This Guide..... | 1 |
| Conventions of This Guide..... | 2 |
| <i>A Note about Icons</i> | 2 |
| Safety Precautions..... | 2 |
| Minimum System Requirements..... | 3 |
| Box Contents..... | 4 |
| Scanner Overview..... | 5 |
| CHAPTER I. INSTALLING THE SCANNER | 7 |
| Software Installation Requirements..... | 7 |
| Hardware Requirements..... | 7 |
| Installing and Setting up the Scanner..... | 8 |
| <i>Step 1. Unlock Your Scanner</i> | 8 |
| <i>Step 2. Connecting the Scanner to Your Computer</i> | 10 |
| <i>Step 3. Installing the Software</i> | 10 |
| <i>Step 4. Testing the Scanner</i> | 11 |
| CHAPTER II. SCANNING | 13 |
| Preparing Documents..... | 13 |
| <i>Checking Document Conditions</i> | 13 |
| Placing Documents..... | 14 |
| <i>Using the Flatbed</i> | 14 |
| Scanning Documents..... | 14 |
| <i>Scanning from the Scanner's Panel or On-screen MacAction's Execute Menu</i> | 14 |
| <i>Scanning from the Icon in the Left Side of the MacAction Window</i> | 17 |
| CHAPTER III. CARE AND MAINTENANCE | 18 |
| Cleaning the Scanner..... | 18 |
| <i>Cleaning Materials</i> | 18 |
| <i>Cleaning the Flatbed</i> | 18 |
| Aligning the Scanner..... | 19 |
| Standby Mode..... | 20 |
| Scanner Lock..... | 20 |
| CHAPTER IV. TROUBLESHOOTING | 22 |
| Scanner Connection..... | 22 |
| APPENDIX A: SPECIFICATIONS | 23 |
| APPENDIX B: CUSTOMER SERVICE AND WARRANTY | 24 |
| Service & Support Information (For EU country only)..... | 24 |
| Statement of Limited Warranty..... | 25 |
| FCC Radio Frequency Statement..... | 26 |

INTRODUCTION

Thank you for choosing us as your scanner supplier. Your new scanner will improve the professionalism of your day-to-day computing tasks by allowing you to input images and electronic text into your computer system.

Like all of our products, your new scanner is thoroughly tested and backed by our reputation for unsurpassed dependability and customer satisfaction. We hope you will continue to turn to us for additional quality products as your computing needs and interests grow.

HOW TO USE THIS GUIDE

This User's Guide provides instructions and illustrations on how to install and operate your scanner. This guide assumes the user is familiar with Apple Mac OS X. If this is not the case, we suggest you learn more about Apple Mac OS X by referring to your Apple Mac OS X manual before using your scanner.

The Introduction section of this manual describes the box contents and minimum computer requirements to use this scanner. Before you start installing your scanner, check the box contents to make sure all parts are included. If any items are damaged or missing, please contact the vendor where you purchased your scanner or our customer service directly.

Chapter I describes how to install the scanner's software and connect the scanner to your computer. Note: The scanner connects to your computer through the Universal Serial Bus (USB). If your computer does not support USB technology, you will need to purchase a USB interface card to add USB capabilities to your computer, or buy and install USB connectors if your motherboard has USB capabilities. This guide assumes that your computer is USB-ready and has a free USB port.

Chapter II describes how to use your scanner.

Chapter III describes how to maintain and clean your scanner.

Chapter IV contains technical support information that can help you solve simple problems.

Appendix A contains the specifications of the scanner you purchased.

Appendix B contains our customer service, the limited warranty agreement and FCC statement concerning the product.

CONVENTIONS OF THIS GUIDE

Bold —Represents commands or contents on your computer screen.

ALL CAPS —Important note or first use of an important term in a chapter.

Italic —Represents buttons on your scanner OR important notes.

A Note about Icons

This guide uses the following icons to point out information that deserves special attention.



Warning

A procedure that must be followed carefully to prevent injury, or accidents.



Attention

Instructions that are important to remember and may prevent mistakes.



Information

Optional tips for your reference.

SAFETY PRECAUTIONS



Warning

Before using this device, please read the following important information to eliminate or reduce any possibility of causing damage and personal injury.

1. Usage, the product is for indoor use in dry locations. Moisture condensation may occur inside this device and cause malfunction at these conditions:
 - when this device is moved directly from a cold to a warm location;
 - after a cold room is heated;
 - when this device is placed in a damp room.

To avoid the moisture condensation, you are recommended to follow the procedure:

- i. Seal this device in a plastic bag for it to adapt to room conditions.
- ii. Wait for 1-2 hours before removing this device from the bag.
2. Do use the AC adapter, power cable and USB cable provided with the scanner. Use of other AC adapter and cables may lead to malfunction.
3. Keep the space around the AC adapter and power cable clear in case you need to

quickly unplug the AC adapter during emergencies.

4. Damaged wire could cause fire or electrical shock. Keep the power cord straight and without being twisted, bended, or scraped.
5. Unplug this device if you don't need to use it for a certain period of time, such as, during night or long weekend, to avoid any risks of causing fire.
6. Do not attempt to disassemble the scanner. There is danger of an electrical shock and opening your scanner will void your warranty.
7. Be sure not to bump or knock the scanner glass as it is fragile and could break.
8. Do not subject the scanner to excessive vibration. It may damage the internal components.

MINIMUM SYSTEM REQUIREMENTS¹

- PC with Intel Core i5 processor or higher
- 4 GB RAM or higher (For maximum A3 size@1600 dpi scanning, allocated 20 GB Virtual Memory at least.)
- Available USB 2.0 port
- DVD-ROM Drive
- 800 MB Free Hard Disk Space
- Video card that supports 16-bit color or greater
- Operating System: Apple Mac OS X 10.12 / 10.13 / 10.14 / 10.15

¹ Higher requirements might be needed when scanning or editing a large quantity of image data. The system requirements here are only a guideline, as in general the better the computer (motherboard, processor, hard disk, RAM, video graphic card), the better the results.

BOX CONTENTS²

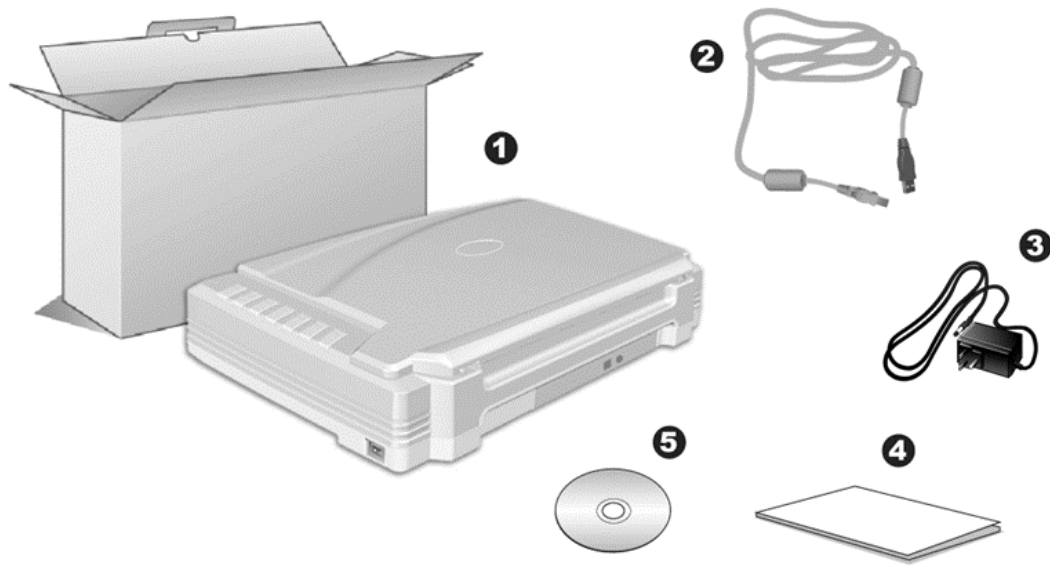

1. Scanner³
2. USB Cable
3. AC Adapter
4. Quick Guide
5. Mac Setup/Application DVD-ROM

² Save the box and packing materials in case you need to transport this scanner in the future.

³ The scanner illustration(s) in this manual may appear different than from the actual scanner itself.

SCANNER OVERVIEW

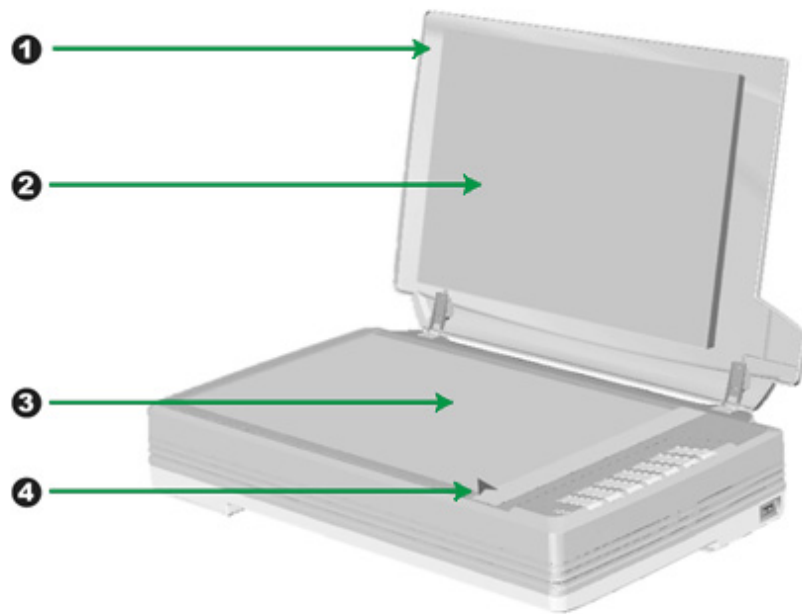

1. DOCUMENT COVER— Helps keep the paper in place and protects the scanner glass.
2. DOCUMENT PAD— Keeps the paper in place and improves accuracy of image quality.
3. SCANNER GLASS— Where you put items for flatbed scanning.
4. REFERENCE MARK— Align your paper with this reference mark for flatbed scanning.

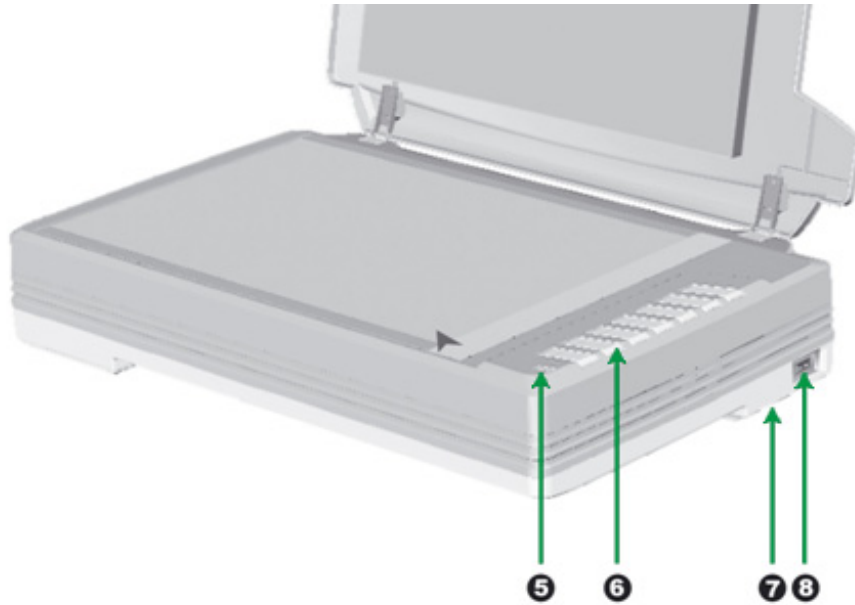

5. POWER LED— Indicates the scanner status.

| Light | Status |
|--------|---|
| Green | The scanner is turned on, ready to scan images. |
| Orange | The scanner is in standby mode if it is idle for 10 minutes. |
| Off | The scanner is off, either because the power is not turned on, or because the power cord is not properly plugged into an AC power outlet. |

6. SCANNER BUTTONS—You may press any button to perform a predefined scanning task.

7. SCANNER LOCK (located on the scanner's underside)— Holds your scanner head in place during transportation.

8. POWER SWITCH— Use this to turn the scanner ON or OFF.

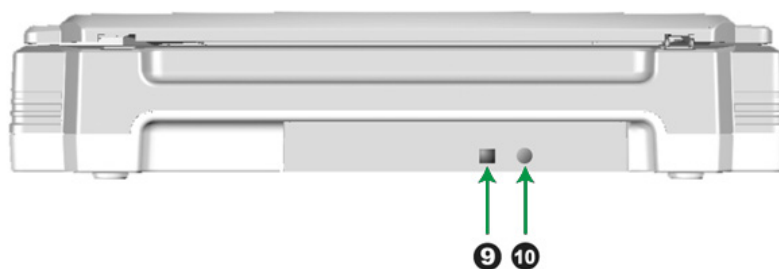

9. USB PORT— Connects the scanner to a USB port on your computer by the USB cable included.

10. POWER RECEPTOR— Connects the scanner to a standard AC power outlet by the AC adapter included.

CHAPTER I. INSTALLING THE SCANNER

Before installing your scanner, please verify that you have all of the proper components. A list of the package contents is provided in the “Box Contents” section of this guide.

SOFTWARE INSTALLATION REQUIREMENTS

Your scanner comes with the scanner’s driver and the task management software (Plustek MacAction). All of these software applications use approximately 400 megabytes of hard disk space after they are installed into your computer. To ensure ample room for the installation, as well as for scanning and saving images, a minimum of 1 GB of hard disk space is recommended.

The USB scanner can only operate under the Apple Mac OS X 10.12 / 10.13 / 10.14 / 10.15 operating system.

HARDWARE REQUIREMENTS

This scanner connects to your computer through the Universal Serial Bus (USB) which supports HOT PLUG AND PLAY. To determine whether your computer is USB-capable, you must check the rear of your PC to locate a USB jack that looks like the picture below. If you are having trouble in locating the USB port on your computer, please refer to the hardware manual that came with your computer.

Upon examination, you should find one or two rectangular USB ports, which usually appear as shown below.

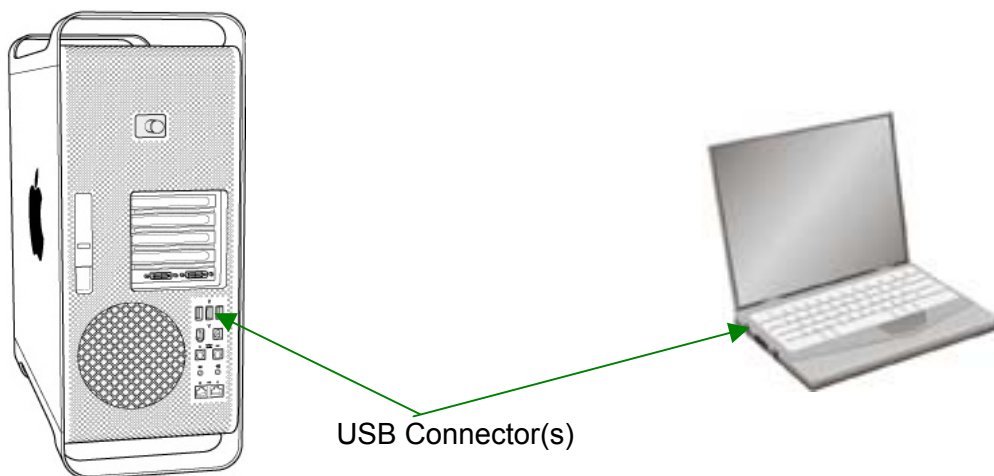

If you don't find such USB ports on your computer, then you need to purchase a certified USB interface card to add USB capabilities to your computer.

INSTALLING AND SETTING UP THE SCANNER

Please follow the step-by-step procedures described below to install the Plustek scanner.

| | |
|------------------|---|
| | Choose a Proper Site First! |
| Attention | <ul style="list-style-type: none">● Always place your scanner on a level, smooth and strong surface before proceeding the scanner setup or any scanning task. Tilted or uneven surface may cause paper-feeding errors, scanner damage or personal injury.● Avoid using the scanner in a dusty environment. Dust particles and other foreign objects may damage the unit. |

Step 1. Unlock Your Scanner

This scanner is designed with a locking mechanism to hold the scanning head in place during transportation. Before you connect your scanner with the computer, ensure to unlock your scanner first.

To unlock the scanner, slide the locking switch on the scanner's underside toward the back panel of the scanner until it snaps into place. Refer to the "Standby Mode

To save power consumption, the scanner will enter the standby mode after it is idle for a while. You may disable the standby mode or define an idle time for the scanner to automatically enter the standby mode.

1. Right-click the icon  in the Dock, and then choose **Scanner Utility** in the pop-up menu that opens.
2. In the **Standby Mode** section of the Scanner Utility window that opens, click the button of your option:
 - a. To disable the Standby Mode: Click the button before **Disable Standby Mode**.
 - b. To automatically enter the Standby Mode (Sleep): Click the button before **Sleep** and then click the up or down arrows to set a default time for the scanner to automatically enter the Standby Mode.

| | |
|--------------------|--|
| | The scanner will enter the standby mode after it is idle for 10 minutes. Simply press any scanner button on the scanner panel and the scanner will return back to the normal status. |
| Information | |

3. Click on **OK** button to save settings and exit.



Warning

- To completely shut down the scanner, press the power switch on the side of the scanner.
- If the scanner will not be used for a long period of time, shut down the scanner and then disconnect the power cable from the power outlet.

Alternatively you may click **Default** to restore the default settings. You may press any scanner button to wake up the scanner from power saving.

Scanner Lock” section of this guide for more details.

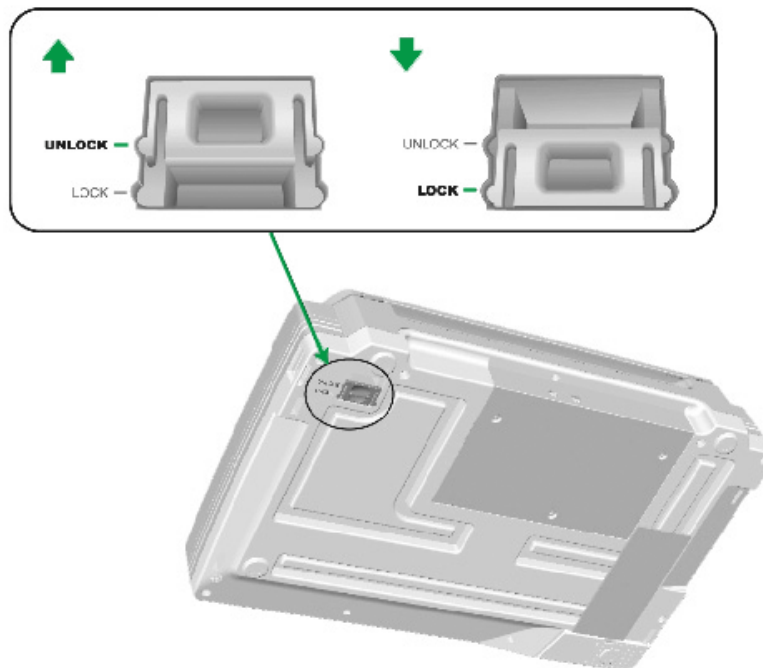

Step 2. Connecting the Scanner to Your Computer

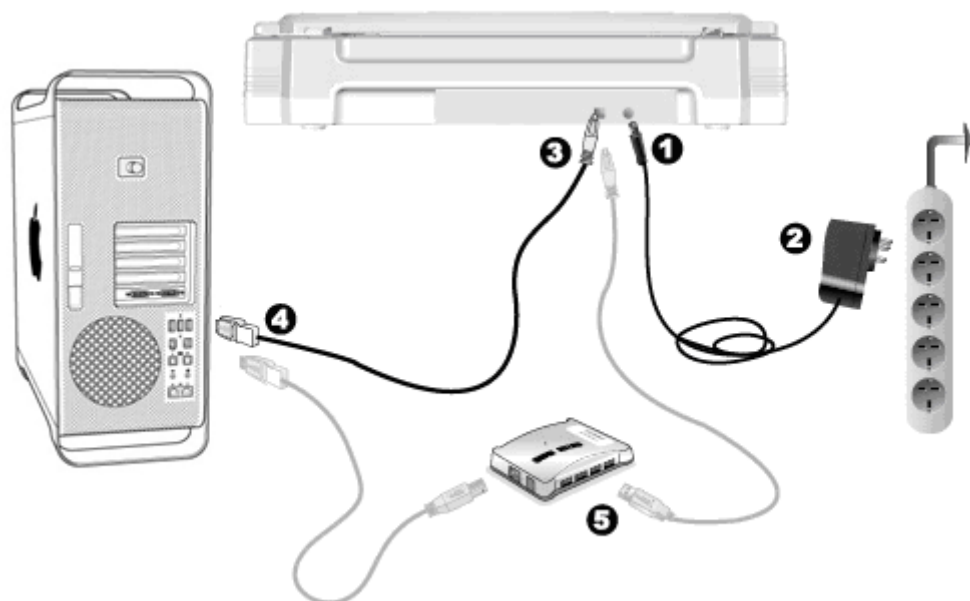

Attention

Please make sure the scanner is turned OFF before you plug or unplug the scanner power adapter.

1. Plug the AC adapter into the scanner's power receptor.
2. Plug the other end of the power cable into a standard AC power outlet.
3. Plug the square end of the included USB cable to the USB port at the rear of the scanner.
4. Plug the rectangular end of the USB cable to an available USB port on your computer.
5. If you plan to connect your scanner to a USB hub⁴, make sure that the hub is connected to the USB port in your computer. Next, connect the scanner to the USB hub.

Step 3. Installing the Software

1. Switch on the scanner power from the side of the scanner.
2. Insert the Mac Setup/Application DVD-ROM, included with your scanner, into your DVD-ROM drive and a **Plustek Scanner** DVD icon  will show on the desktop of your Mac OS X.
3. Double-click on the DVD icon, and a window will pop up displaying the file folder.
4. Double-click on the setup file **Setup**, and the Scanner Installer will start to guide

⁴ The USB hub is not included with the scanner.

- you through the installation. Follow the on-screen guide in the installer window.
5. You will be prompted to enter your Mac administrator password. Enter the password to continue the installation. **Note: Only the Mac administrator can perform the installation. Please make sure that you log in the Mac OS as an administrator.**
 6. When the installation finishes, click the **Close** button to exit the installer.

| | |
|---|---|
|  | Save the Setup/Application DVD in case you need to reinstall the driver and software in the future. |
| Attention | |



Step 4. Testing the Scanner

The following describes how you can check if the scanner is properly functioning with your computer and the scanning software. Before testing your scanner, double check to make sure that all connections are securely fastened.

To test the flatbed scanning:

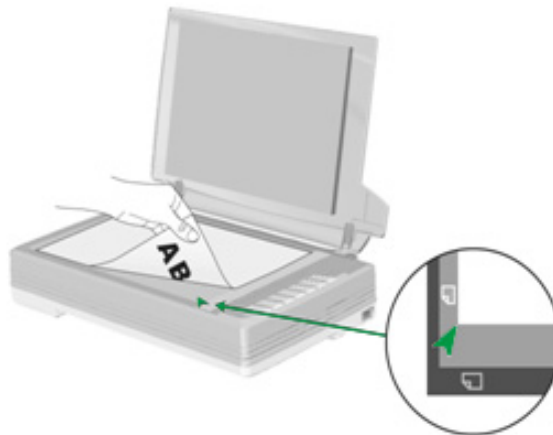
1. Open the scanner's document cover. Place the document onto the scanner glass headfirst and face-down. Align the top left corner of the document with the arrow on the reference mark.



2. Gently close the document cover.
3. Do one of the following to open the Button Configuration window:
 - Click the icon  in the Dock.
 - Right-click the icon  in the Dock, and then choose **Button Configuration** in the pop-up menu that opens.

4. Clicking the “1” icon on the left pane in the Button Configuration window displays its current button settings on the right pane. In the Button Configuration window, choose from the dropdown list of Button Template to select “File Utility”, and keep in mind the default saving folder show in the “Saving folder” dropdown list.
5. Press the “1” button on the scanner and the scanning starts immediately. You’ll see a scanned image of the document in the default saving folder; your scanner is working properly.

CHAPTER II. SCANNING

Your scanner needs to be driven by certain type of software program. Since all documents or images (whether text or pictures) that are acquired from the scanner are treated by your computer as images, most scanning will probably be done from an image-editing program where you can view, edit, save and output the scanned images.

What about scanning text documents and editing them in a word processor? This is the role of Optical Character Recognition (OCR) software. OCR software converts the image files that are created from scanning text documents into text files that can be viewed, edited and saved by word processors.

The MacAction program, seamlessly integrating the operation of your scanner with your computer and other peripherals, provides a quick and convenient way to perform various scanning functions. With MacAction, you don't need to adjust settings every time you scan. Simply press any button on the scanner's front panel or click any scanning menu item of MacAction on the screen. The scanner starts to scan your paper documents and transfer them to your assigned destination. The destination can be a printer, your e-mail program, files on your disk drives, an image-editing program, etc.

Please refer to the online help of each program to guide you through any questions you may have while scanning within that program.

This chapter describes three important steps of scanner operations. Read them thoroughly and follow the instructions to ensure correct use and optimal scanner performance.

Step 1. Preparing Documents

Step 2. Placing Documents

Step 3. Scanning Documents

PREPARING DOCUMENTS

Proper document preparation prior to the scan can prevent paper feed errors and damages to the scanner.

- Checking Document Conditions

Checking Document Conditions

Make sure the paper sizes of your documents are acceptable by the scanner. Refer to "Appendix A: Specifications4F" of this guide for more information.

PLACING DOCUMENTS

Using the Flatbed

1. Open the scanner's document cover.
2. Place the document onto the scanner glass headfirst and face-down. Align the top left corner of the document with the arrow on the reference mark.

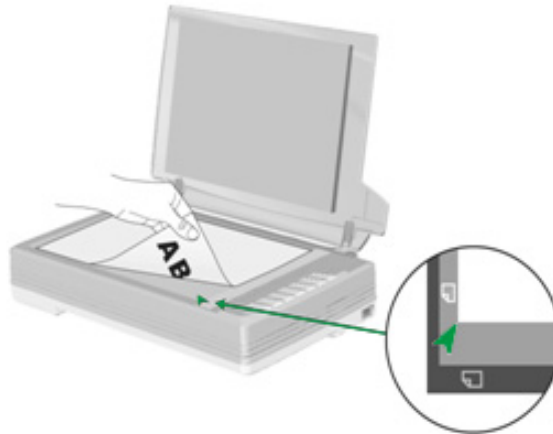

3. Gently close the document cover.

SCANNING DOCUMENTS

There are 3 different ways to operate the scanner:

1. By scanning from the scan buttons on the scanner.
2. By scanning from MacAction's Execute menu on the screen.
3. By scanning from the icon in the left side of the MacAction window.

The MacAction software is automatically installed to your system along with the scanner driver.



Attention

Before you start scanning, check the following:

- Your scanner has been unlocked and the power of both your computer and scanner is turned on.
- Paper is appropriately placed on the scanner flatbed glass.

Scanning from the Scanner's Panel or On-screen MacAction's Execute Menu



The settings for each button on the scanner's panel are configured through MacAction. MacAction offers you quick access to the most frequently-used scanning

functions. They are especially useful when you need to repeatedly scan with the same settings and send images to the same destination.

Buttons on the scanner panel will be used in this guide to demonstrate the scanner operations. You may also use MacAction's on-screen Execute menu to perform the same scanning tasks.

Configure Button Settings

Before performing your first scan via scanner buttons, you are recommended to configure the button settings to your needs and preferences first. There are three ways to configure or view the button settings of MacAction:

- Double-click the icon  in **Finder > Applications > Plustek > Your scanner model name**.
- Click the icon  in the Dock.
- Right-click the icon  in the Dock, and then choose **Button Configuration** in the pop-up menu that opens.

Within the “Button Configuration” window, you can find a row of icons running through the left side of the window. Each icon corresponds to a button on your scanner's panel (as well as MacAction's on-screen Execute menu). Clicking any icon on the left pane and its current button settings are displayed immediately on the right pane. You may adjust the settings as desired.

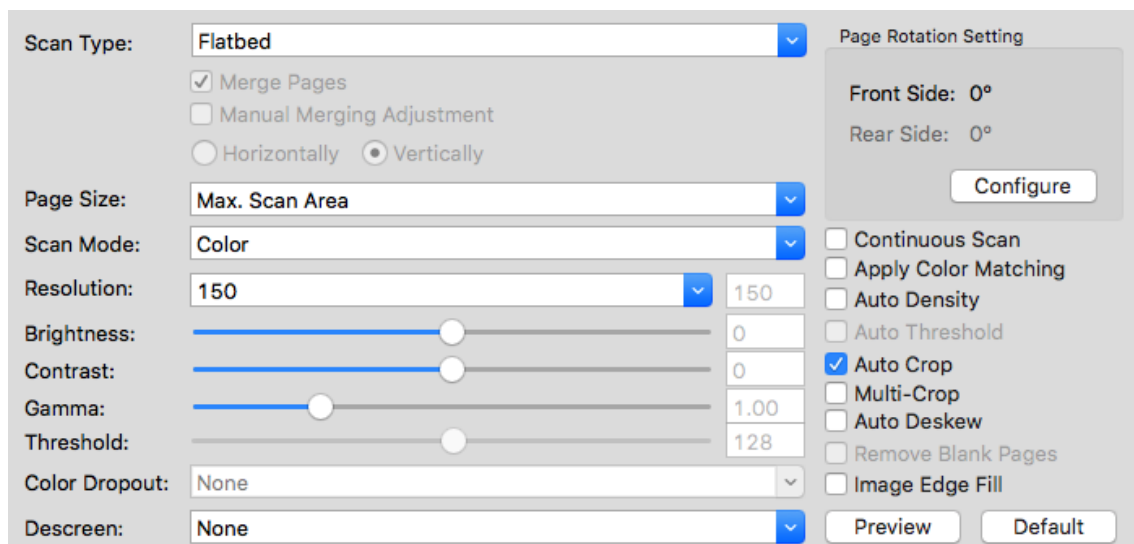

Click the **Help** button within the Button Configuration window for more information about the settings.

Scan from the Buttons

Scanning documents or images from this scanner is very easy. Follow the two steps described below:

1. Place the document or images onto the scanner. (Refer to “Chapter II. Scanning” of this guide for more information in placing paper on the flatbed glass properly.)

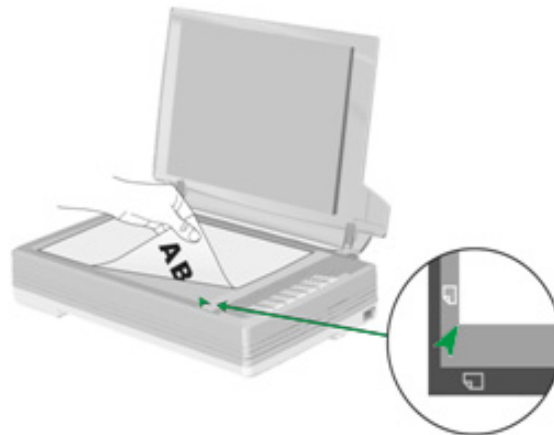

Attention

Place only text documents for OCR purposes. Do not scan a photo using the OCR button.

2. Do one of the following to start scanning:
 - Press the button from the scanner's panel.

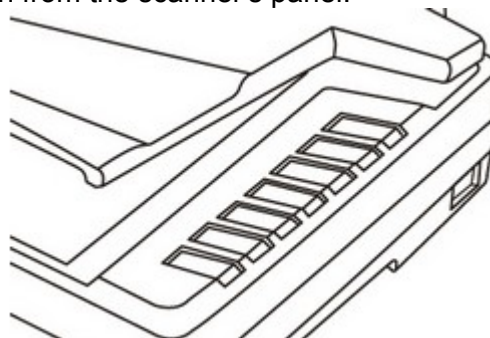

- Right-click the icon  in the Dock, and then choose Execute in the pop-up menu that opens. Click the desired button function item in the pop-up menu.

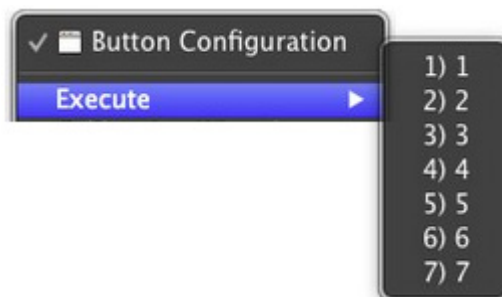

The scanner starts to scan immediately and carry out the corresponding action according to the settings you have set up in the Button Configuration window.

Scanning from the Icon in the Left Side of the MacAction Window

You can perform scanning task by double-clicking the icon in the left side of the MacAction window. Follow the steps described below:

1. Place the document or images onto the scanner.

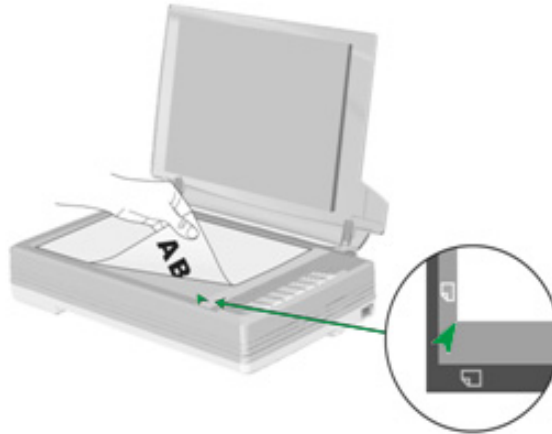

2. Check current button settings by viewing the Button Configuration window. If needed, you may also modify settings to meet your current needs.

| | | |
|--|----------------|---|
| Scan Type: | Flatbed | Page Rotation Setting |
| <input checked="" type="checkbox"/> Merge Pages | | Front Side: 0° |
| <input type="checkbox"/> Manual Merging Adjustment | | Rear Side: 0° |
| <input type="radio"/> Horizontally <input checked="" type="radio"/> Vertically | | <input type="button" value="Configure"/> |
| Page Size: | Max. Scan Area | |
| Scan Mode: | Color | <input type="checkbox"/> Continuous Scan |
| Resolution: | 150 | <input type="checkbox"/> Apply Color Matching |
| Brightness: | 0 | <input type="checkbox"/> Auto Density |
| Contrast: | 0 | <input type="checkbox"/> Auto Threshold |
| Gamma: | 1.00 | <input checked="" type="checkbox"/> Auto Crop |
| Threshold: | 128 | <input type="checkbox"/> Multi-Crop |
| Color Dropout: | None | <input type="checkbox"/> Auto Deskew |
| Descreen: | None | <input type="checkbox"/> Remove Blank Pages |
| | | <input type="checkbox"/> Image Edge Fill |
| | | <input type="button" value="Preview"/> <input type="button" value="Default"/> |

3. Double-clicking the desired icon in the left side of the MacAction window.



The scanner starts to scan immediately and carry out the corresponding action according to settings you have set up in the Button Configuration window.

CHAPTER III. CARE AND MAINTENANCE

Your scanner is designed to be maintenance-free. However, constant care and maintenance can keep your scanner working smoothly.

CLEANING THE SCANNER

Paper powder, dust, ink and toner from paper being scanned may make the scanner glass dirty, which leads to poor image quality or document-feeding errors. How often to clean your scanner depends on the type of paper and number of pages being scanned.

Perform the following procedures to clean the scanner surface and scanner glass. Gently wipe locations described herein. Do not rub too hard.



Warning

- Before cleaning the scanner, turn off the scanner and disconnect the scanner's power cable and USB cable, and then wait a few minutes for the glass to cool to ambient temperature.
- Wash your hands with soap and water after cleaning the scanner.

Cleaning Materials

Have the following cleaning materials ready to clean the scanner:

- **soft, dry, lint-free cloth (or a cotton swab)**
- **non-abrasive cleaner**—Isopropyl alcohol (95%). DO NOT use water.



Attention

Alternatively you can use glass cleaner or neutral detergent for windows cleaning to clean the scanner glass.

Use of other cleaning materials could damage your scanner.

Cleaning the Flatbed

1. Open the document cover.
2. Gently wipe the following areas with the cloth dampened with the cleaner.

Clean Document Pad & Scanner Glass:

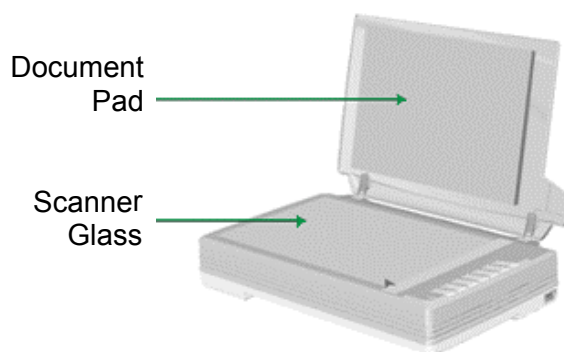

3. Wait for cleaned areas to dry completely.
4. Gently close the document cover.

ALIGNING THE SCANNER

In most cases, the scanner doesn't need to be aligned but there are instances when the alignment might be required. You need to align the scanner only if parts of the scanned document are missing from any of its edges. For example, the heading of a document might be missing from the top edge after the document has been scanned.

Alignment for Flatbed Scan:

1. Place the document onto the scanner glass headfirst and face-down. Align the top left corner of the document with the arrow on the reference mark.
2. Right click the icon  in the Dock and select **Scanner Utility** from the menu that pops up.
3. The Scanner Utility window opens. Find the **Initial Scanning Position Alignment** section and select **Flatbed** as the source.
4. Click the **Scan** button. Part of the document image will be displayed in the Alignment Window.
5. Click the **Alignment Position** buttons (Up, Down, Left, Right) until the top left corner of the scanned document aligns with the top left corner of the Alignment Window.
6. When the alignment completes, click on **OK** button to save settings and exit.

STANDBY MODE

To save power consumption, the scanner will enter the standby mode after it is idle for a while. You may disable the standby mode or define an idle time for the scanner to automatically enter the standby mode.

1. Right-click the icon  in the Dock, and then choose **Scanner Utility** in the pop-up menu that opens.
2. In the **Standby Mode** section of the Scanner Utility window that opens, click the button of your option:
 - a. To disable the Standby Mode: Click the button before **Disable Standby Mode**.
 - b. To automatically enter the Standby Mode (**Sleep**): Click the button before **Sleep** and then click the up or down arrows to set a default time for the scanner to automatically enter the Standby Mode.

| | |
|---|--|
|  Information | The scanner will enter the standby mode after it is idle for 10 minutes. Simply press any scanner button on the scanner panel and the scanner will return back to the normal status. |
|---|--|

3. Click on **OK** button to save settings and exit.

| | |
|---|---|
|  Warning | <ul style="list-style-type: none">● To completely shut down the scanner, press the power switch on the side of the scanner.● If the scanner will not be used for a long period of time, shut down the scanner and then disconnect the power cable from the power outlet. |
|---|---|

Alternatively you may click **Default** to restore the default settings. You may press any scanner button to wake up the scanner from power saving.

SCANNER LOCK

Your scanner is designed with two different lock statuses to protect the optical parts. To ensure the scanner working properly, you have to choose an appropriate lock status according to the situation.

Always Unlock:

A scanning-ready status. Furthermore, if you place your scanner on a long-term position, you can also keep your scanner lock in this status. To unlock the scanner, slide the locking switch on the scanner's underside toward the back

panel of the scanner until it snaps into place.

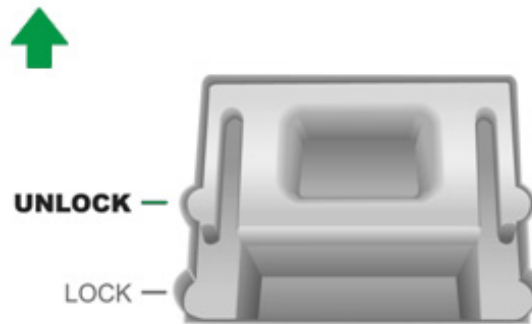

Always Lock:

It holds the scanning head in place during transportation and traveling. The scanner will be kept in disabled status. To lock the scanner, slide the locking switch on the scanner's underside toward the power LED of the scanner until it snaps into place.

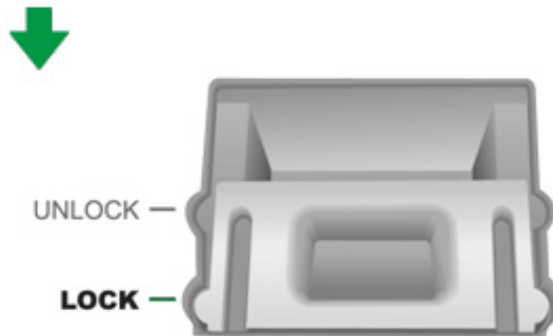

Warning

When you need to move the scanner, do lock the scanner to ensure accurate and problem-free use of your scanner.

CHAPTER IV. TROUBLESHOOTING

If you encounter problems with your scanner, please review the installation and scanning instructions contained in this guide.

SCANNER CONNECTION

The first step to take when troubleshooting connection problems with your scanner is to check all physical connections. The icon , located on the Dock, indicates if the scanner software is properly launched and the scanner and computer are communicating with each other.

| Appearance | Status |
|---|--|
|  | The program has been successfully launched and the scanner is connected with the computer, ready to scan images. |
| No Display | You have chosen to terminate the program, no matter the scanner is connected or disconnected with the computer. |

APPENDIX A: SPECIFICATIONS⁵

| Plustek OpticPro A320E | |
|-------------------------------|--|
| Image Sensor | CCD |
| Optical Resolution | 800 dpi |
| Scan Modes | Color: 48-bit input, 24-bit output Grayscale: 16-bit input, 8-bit output B/W: 1-bit output |
| Color Depth | Input 48-bit; Output 24-bit |
| Scanning Speed | 7.8 sec (Color/ Grayscale/ B&W mode, 300dpi, A3) |
| Scanning Area (W x L) | Max. 304.8 mm x 431.8 mm (12" x 17"), A3 |
| Daily Duty Scan (Sheets) | 2,500 |
| Action Button | 1~7 |
| Power Supply | 24 Vdc/ 1.0 A |
| Power Consumption | ≤30 W (operation), ≤2.9 W (idle), ≤0.3 W (standby) |
| Interface | USB 2.0 |
| Net Weight | 7.5 Kgs (16.52 Lbs) |
| Dimensions (W x D x H) | 623 x 400 x 140 mm (24.53" x 15.75" x 5.51") |
| Protocol | TWAIN Compliant, WIA |

⁵ Hardware specifications may change at any time without prior notice.

APPENDIX B: CUSTOMER SERVICE AND WARRANTY

Visit our website www.plustek.com for more customer service information. To avoid delays, please have the following information available:

- Scanner name and model number
- Scanner serial number (located at the bottom of the scanner)
- Scanner DVD version and part number
- A detailed description of the problem
- Your computer manufacturer and its model number
- The speed of your CPU
- Your current operating system and BIOS (optional)
- Name of software package(s), version or release number and manufacturer of the software
- Other USB devices installed

SERVICE & SUPPORT INFORMATION (FOR EU COUNTRY ONLY)

Where appropriate, the period of availability of spare parts and the possibilities of upgrading products information. Please ask local distributors and suppliers for spare parts information and product upgrade information.

Information requested by relevant Implementing Measure. Please ask local distributors and suppliers for the related information of Implementing Measure test report.

Do not dispose anything of products before you ask local distributors and suppliers to get correct information for decreases of environmental impact with right methods and procedures.

If you want to disposals the product and/or an accessory, please ask local distributors and suppliers to get the contact information of nearest disposal manufactures.

If you have any maintenance inquiry, please ask local distributors and suppliers to get the contact information of nearest maintenance center in order to extend the product usage life time.

If you want to maintain and clearance the product, please ask local distributors and suppliers to get the right information of nearest stores.

STATEMENT OF LIMITED WARRANTY

This Statement of Limited Warranty applies only to the options you originally purchase for your use, and not for resale, from an authorized reseller.

The manufacturer warranty includes all parts and labor, and is not valid without the receipt of original purchase. To obtain warranty service, you may contact the authorized dealer or distributor, or visit our website to check out the available service information, or send a request via E-mail for further help.

If you transfer this product to another user, warranty service is available to that user for the remainder of the warranty period. You should give your proof of purchase and this statement to that user.

We warrant that this machine will be in good working order and will conform to its functional descriptions in the documentation provided. Upon provision of proof of purchase, replacement parts assume the remaining warranty of the parts they replace.

Before presenting this product for warranty service, you must remove all programs, data and removable storage media. Products returned without guides and software will be replaced without guides and software.

This Limited Warranty service does not provide for carry-in exchange when the problem results from accident, disaster, vandalism, misuse, abuse, unsuitable environment, program modification, another machine or non-vendor modification for this product.

If this product is an optional feature, this Limited Warranty applies only when the feature is used in a machine for which it was designed.

If you have any questions about your Limited Warranty, contact the approved retailer from whom you bought the product or the manufacturer.

THIS LIMITED WARRANTY REPLACES ALL OTHER WARRANTIES, EXPRESS OR IMPLIED, INCLUDING, BUT NOT LIMITED TO, THE IMPLIED WARRANTIES OF MERCHANTABILITY AND FITNESS FOR A PARTICULAR PURPOSE. HOWEVER, SOME LAWS DO NOT ALLOW THE EXCLUSION OF IMPLIED WARRANTIES. IF THESE LAWS APPLY, THEN ALL EXPRESS AND IMPLIED WARRANTIES ARE LIMITED IN DURATION TO THE WARRANTY PERIOD. NO OTHER WARRANTIES APPLY AFTER THAT PERIOD.

Some jurisdictions do not allow limitations on how long an implied warranty lasts, so the above limitation may not apply.

Under no circumstances are we liable for any of the following:

1. Third party claims against you for losses or damages.
2. Loss of, or damage to, your records or data; or
3. Economic consequential damages (including lost profits or savings) or incidental damages, even if we are informed of their possibility.

Some jurisdictions do not allow the exclusion or limitations of incidental or consequential damages, so the above limitation or exclusion may not apply to you.

This Limited Warranty gives you specific legal rights, and you may also have other rights that vary from jurisdiction to jurisdiction.

FCC RADIO FREQUENCY STATEMENT

This equipment has been tested and found to comply with the limits for a Class B digital device, pursuant to part 15 of the FCC rules. These limits are designed to provide reasonable protection against harmful interference in a residential installation.

This equipment generates, uses and can radiate radio frequency energy and, if not installed and used in accordance with the instructions, may cause harmful interference to radio communications. However, there is no guarantee that interference will not occur in a particular television reception (which can be determined by turning the equipment off and on), the user is encouraged to try to correct the interference by one or more of the following measures:

- Reorient or relocate the receiving antenna.
- Increase the separation between the equipment and receiver.
- Connect the equipment to an outlet on a circuit different from that which the receiver is connected.
- Shielded interconnect cables and shielded power cord which are supplied with this equipment must be employed with this equipment to ensure compliance with the pertinent RF emission limits governing this device.
- Consult the dealer or an experienced radio/TV technician for help if the conditions persist.
- Changes or modifications not expressly approved by the manufacturer or authorized service center could void the user's authority to operate this equipment.

This device complies with Part 15 of the FCC Rules. Operation is subject to the following two conditions: (1) this device may not cause harmful interference, and (2) this device must accept any interference received, including interference that may cause undesired operation.

MacAction Online Help

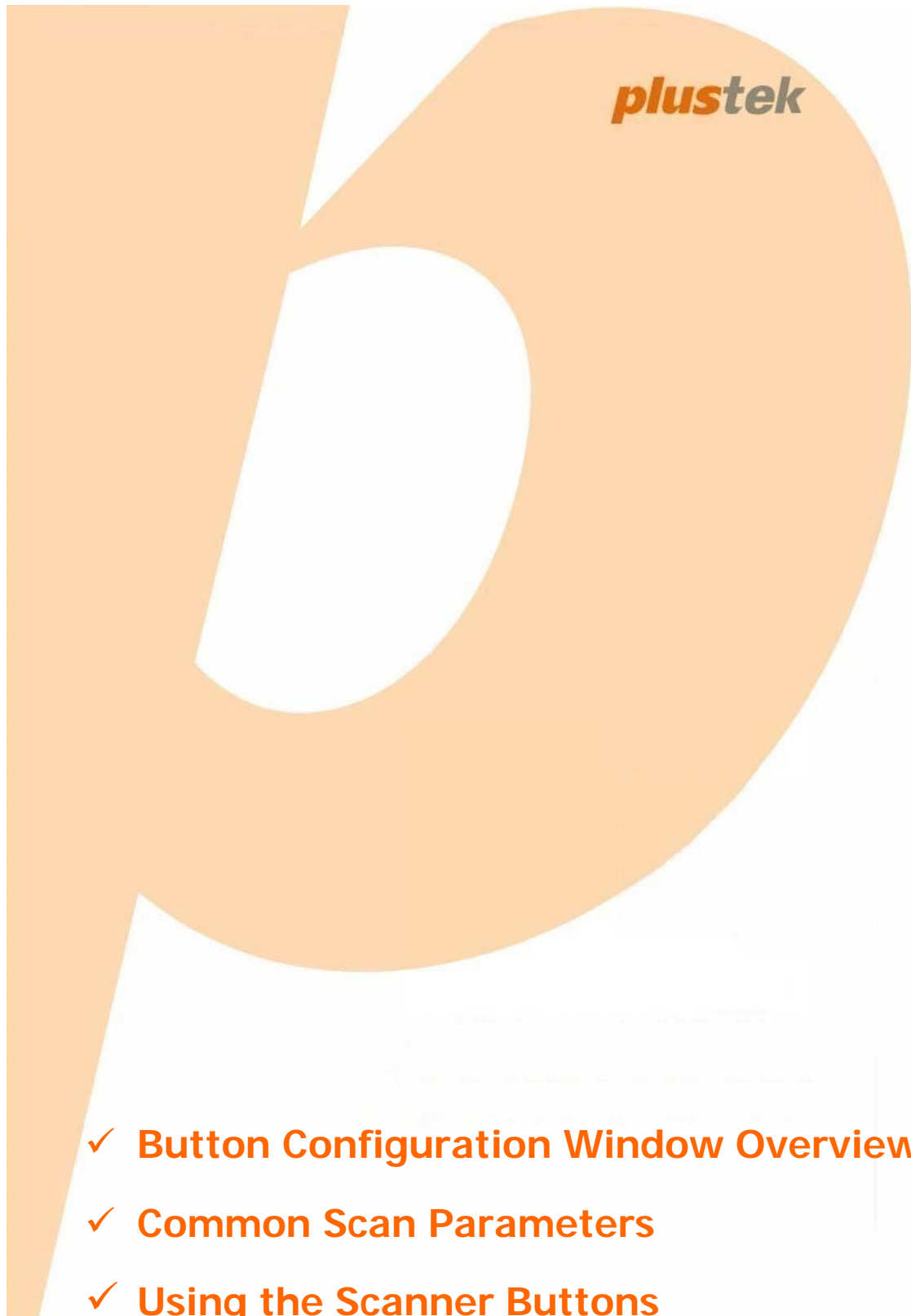

MacAction: Table of Contents

| | |
|---|-----------|
| Part I Introduction | 2 |
| 1 Operate the Scanner | 2 |
| 2 Scanner Utility (This function may or may not be available depending on the scanner model you purchase) | 2 |
| 3 Button Functions Overview | 7 |
| Part II Button Configuration Window Overview | 8 |
| 1 Customize Button Settings | 9 |
| 2 PDF Button Settings | 10 |
| File Name Setup dialog box (for PDF Button Settings) | 12 |
| File Format Configuration dialog box (for PDF Button Settings) | 14 |
| Plustek OCR | 15 |
| 3 FTP Button Settings | 15 |
| FTP Connection Properties dialog box | 17 |
| Save Setup dialog box (for FTP Button Settings) | 18 |
| 4 E-Mail Button Settings | 20 |
| 5 OCR Button Settings | 22 |
| Plustek OCR Configuration | 24 |
| Save Setup dialog box (for OCR Button Settings) | 25 |
| 6 File Button Settings | 27 |
| File Name Setup dialog box (for File Button Settings) | 29 |
| 7 Copy Button Settings | 31 |
| 8 Scan Button Settings | 33 |
| Add/Modify Linked Application dialog box | 36 |
| Save Setup dialog box (for Scan Button Settings) | 37 |
| 9 Common Scan Parameters | 39 |
| 10 File Format Configuration dialog box | 45 |
| Part III Using the Scanner Buttons | 46 |
| 1 Configure Button Settings | 46 |
| How to Configure Button Settings | 47 |
| 2 Scan from the Buttons | 48 |
| 3 How to create searchable PDF documents by MacAction program? | 49 |

1 Introduction

The MacAction program, seamlessly integrating the operation of your scanner with your computer and other peripherals, provides a quick and convenient way to perform various scanning functions.

With MacAction, you don't need to adjust settings every time you scan. Simply press any button on the scanner's panel or click any scanning menu item of MacAction on the screen. The scanner starts to scan your paper documents and transfer them to your assigned destination. The destination can be a printer, your e-mail program, files on your disk drives, an image-editing program, etc. For example, if you want a printout copy of a purchase order, you may do that in only two steps:

Step 1: Place the paper on the scanner.

Step 2: Press the Copy button on the scanner.

The scanner starts scanning instantly and then sends the image directly to your printer.

MacAction makes this integration and convenience possible at your fingertips.

When MacAction is on, you will see the icon  in the Dock. Right-click on this icon will open a pop-up menu and allow you to:

- [Configure button settings](#). The settings for each single-touch button on the scanner's panel are configured through MacAction.
- Perform predefined scanning tasks in the same way as you press a button on the scanner panel.
- Access [Scanner Utility](#) where you may set up the standby mode and adjust the initial scanning position. (This function may or may not be available depending on the scanner model you purchase.)

We will guide you through how to configure button settings and how to use scanner buttons to carry out your different scanning tasks.

1.1 Operate the Scanner

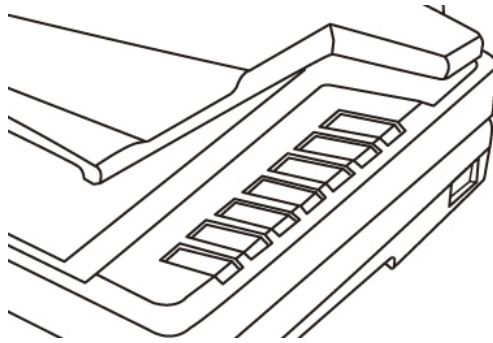

- Scan from MacAction's Execute menu on the screen

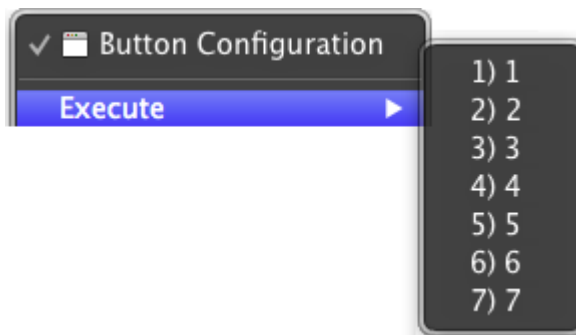

Buttons on the scanner panel will be used in this guide to demonstrate the scanner operations. You may also use MacAction's on-screen Execute menu to perform the same scanning tasks.



In addition to the two fast scanning methods described above, this scanner offers you other ways to scan your paper documents or images. Choose an appropriate scanning method that meets your scanning need and preferences.

- By acquiring images from the scanner through our TWAIN interface within any TWAIN-compliant application programs

1.2 Scanner Utility (This function may or may not be available depending on the scanner model you purchase.)

when the alignment might be required. You need to align the scanner only if parts of the scanned document are missing from any of its edges. For example, the heading of a document might be missing from the top edge after the document has been scanned.

1. Place a document face down onto the scanner glass and align the top left corner of the document with the arrow on the reference mark.

2. Right-click the icon  in the Dock, and then choose **Scanner Utility** in the pop-up menu that opens.

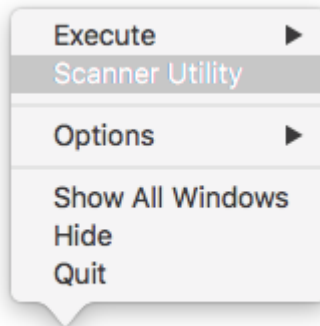

3. The Scanner Utility window opens. Find the **Initial Scanning Position Alignment** section and select **Flatbed** as the scan source.

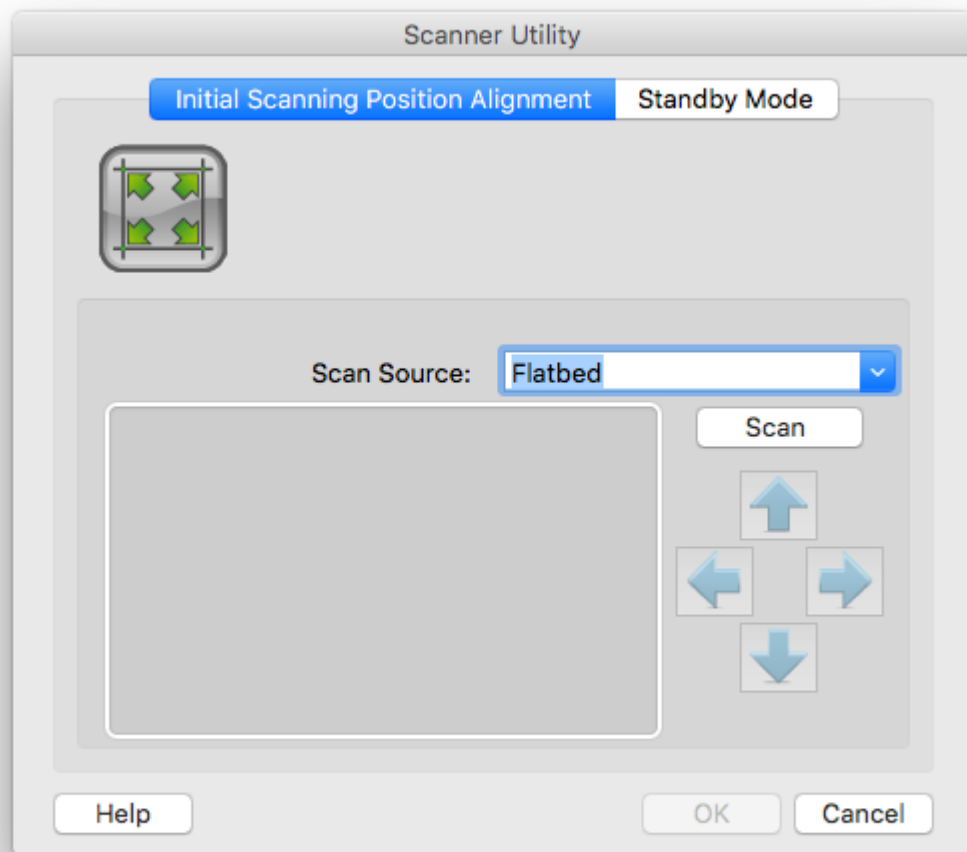

4. Click on the **Scan** button. Part of the document image will be displayed in the Alignment Window.
5. Click on the **Alignment Position** buttons (Up, Down, Left, Right) until the top left corner of the scanned document aligns with the top left corner of the preview window.

pop-up menu that opens.

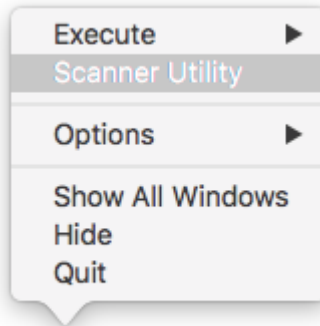

2. In the **Standby Mode** section of the Scanner Utility window that opens, click the button of your option:

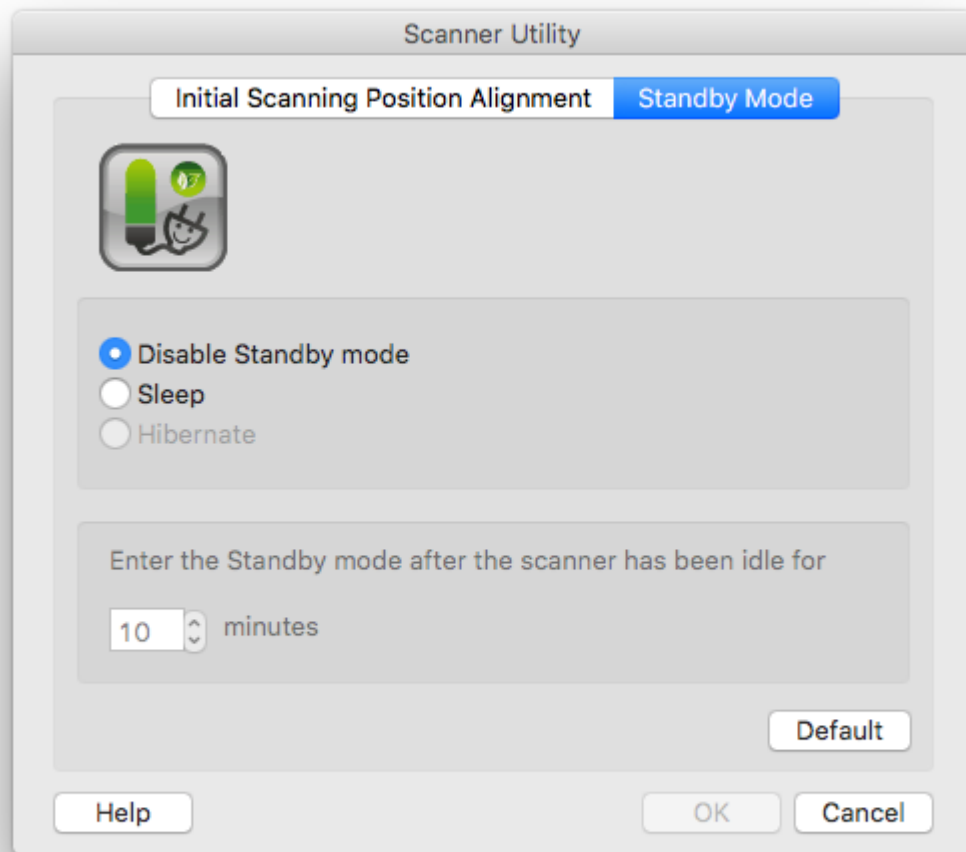

- b. To automatically enter the Standby Mode (Sleep): Click the button before **Sleep** and then click the up or down arrows to set a default time for the scanner to automatically enter the Standby Mode.
 - c. To automatically enter the Standby Mode (Hibernate): Click the button before **Hibernate** and then click the up or down arrows to set a default time for the scanner to automatically enter the Standby Mode. (This function may or may not be available depending on the scanner model you purchase.)
3. Click on **OK** button to save settings and exit.



- To completely shut down the scanner, press the power switch on the side of the scanner.
- If the scanner will not be used for a long period of time, shut down the scanner and then disconnect the power cable from the power outlet.

Alternatively you may click **Default** to restore the default settings. You may press any scanner button to wake up the scanner from power saving.

1.3 Button Functions Overview

Each button on the scanner's panel corresponds to an on-screen scanning button in MacAction program. You are allowed to customize all on-screen scanning buttons as any of the available scanning functions (OCR, File, Scan, Copy, E-Mail, PDF, FTP).

The following button functions are available:

- **OCR--** Scans text documents directly to a text editor or viewer, thus saving

application program, so you don't see the scanning results on screen immediately after the scan. You will find this button useful if you only want to digitize your documents or images and don't want to confirm the scan result right after the scan.

- **Scan**-- Scans documents or images to a linked image-editing application programs for viewing or post processing. Alternatively you may set up this button as a hot key to simply launch any application program without scanning action.



Unlike the File button which simply saves the scanned documents or images to files after the scan is completed, the Scan button not only saves the scanned documents or images to files but also transfer them to a specified image-editing program for you to view or check the scan results.

- **Copy**-- Scans documents or images directly to the printer without saving them to your hard drive, making it ideal for getting a quick copy of a document or image. MacAction transforms your scanner and printer into a convenient office copier.
- **E-Mail**-- Scans documents or images directly to your e-mail program and automatically creates a new message with the image files attached. A copy is automatically saved on your disk drive too.
- **PDF**-- Scans documents and recognizes letters on a page, then write them into a text-searchable pdf file. You may determine where they are saved and how their files are named to best meet your needs.
- **FTP**-- Scans documents or images and saves them to the FTP server. You may determine where they are saved on the FTP server. A copy is automatically saved on your disk drive too.

2 Button Configuration Window Overview

Configuration... in the pop-up menu that opens.

Within the Button Configuration window, you can find a row of icons running through the left side of the window. Each icon corresponds to a single-touch button on your scanner's panel (as well as MacAction's on-screen Execute menu). If not all available buttons are displayed, drag the scrolling bar up and down to navigate through them. Clicking any icon on the left pane and its current button settings are displayed immediately on the right pane. You may adjust the settings as desired.

 If the icon  is not displayed on the Dock, double-click the icon  in **Finder > Applications > Plustek > Your scanner model name.**

2.1 Customize Button Settings

Clicking any icon on the left pane in the Button Configuration window displays its current button settings on the right pane.

The items and parameters available in the window are explained as follows:

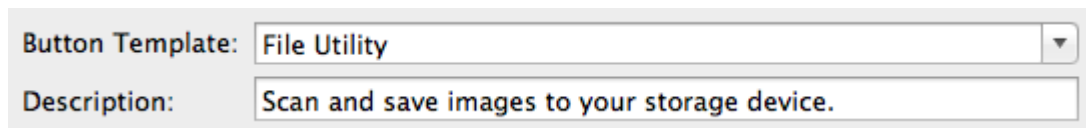



Button Template: File Utility

Description: Scan and save images to your storage device.

Button Template

Each available scanning function (Scan, Copy, OCR, File, E-Mail, PDF, FTP) has been especially designed as an individual button template, which gives you great convenience and time-saving in configuring the settings to meet your needs. By simply selecting one function from the drop-down menu, you may turn this Custom button into your frequently-used scanning function.

-  [File Button Settings](#)
-  [Scan Button Settings](#)
-  [Copy Button Settings](#)
-  [E-Mail Button Settings](#)
-  [PDF Button Settings](#)
-  [FTP Button Settings](#)

2.2 PDF Button Settings

Clicking the **PDF** icon on the left pane in the Button Configuration window displays its current button settings on the right pane.

The settings can be categorized into two: [File Saving Settings](#) on the upper part, and [Scan Parameters](#) on the lower part.

The items and parameters available in the window are explained as follows:

File Saving Settings

Determine how the scanned documents or images are saved to files.

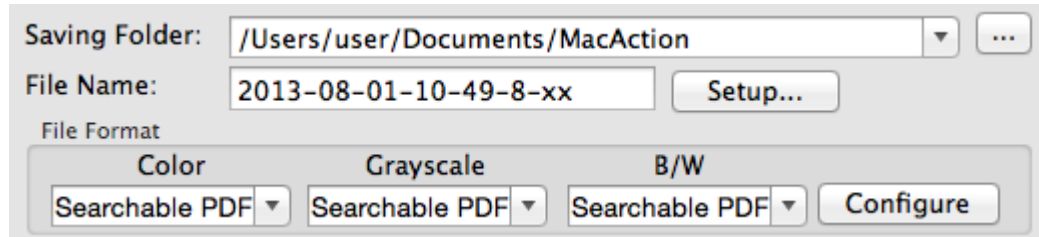

Saving Folder

The scanned documents or images are automatically saved to the folder displayed here.

To select or modify the saving folder, click  to open a dialog box where you

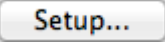
a different format, click  to open the [File Name Setup](#) window.

File Format

Determines the image file format to save the scanned documents or images to. The following file formats are available from the drop-down list box:

- Searchable PDF
- PDF

Different file formats can be set for different scan modes. You may simply change the [scan parameters](#).

Clicking  opens the [File Format Configuration](#) window where you may configure advanced settings for Searchable PDF and PDF file formats.

Scan Parameters

- [Scan Type](#)
- [Page Size](#)
- [Scan Mode](#)
- [Resolution](#)
- [Brightness](#)
- [Contrast](#)
- [Gamma](#)
- [Threshold](#)
- [Color Dropout](#)
- [Descreen](#)
- [Page Rotation Setting](#)
- [Continuous Scan](#)
- [Apply Color Matching](#) (This function may or may not be available depending on the scanner model you purchase.)
- [Auto Density](#)
- [Auto Threshold](#)

2.2.1 File Name Setup dialog box (for PDF Button Settings)

You are allowed to name the saved files in two ways:

- using the "Date and Time" format; or
- using customized prefix and numbering scheme.

You can see the file naming example on screen--near the bottom of this dialog box--immediately after you make any adjustments. The file name extension is automatically added according to the file format you set up.

The items and parameters available in the window are explained as follows:

Date and Time

If you choose to name the saved files in Date and Time format, you may use either option as follows:

Use operating system setting

Files are named according to the date and time setting of the operating system of your computer. You may access System Preferences of your operating system to view or permanently modify your current date and time setting.

User-defined

This setting allows you to customize the date and time naming format for your current need. The data and time setting of your operating system remains unchanged.

Custom

The prefix and the numbering scheme are combined to form the file name. Choose this one if you want to have MacAction automatically save scanned images in a consistent naming and numbering pattern.

Prefix

The text you enter here will become the file name prefix.

Overwrite the file of the same name

What if a file with the same file name and file extension combination happens to already exist in the assigned saving folder? MacAction offers you two options as follows:

- Tick this check box and have MacAction overwrite the existing file with the newly-scanned image.
- Clear this check box and have MacAction not only save the newly-scanned image to file according to your customized prefix and numbering scheme but also append the date and time of your operating system at the end of the file name. For example, if the file "News clipping_027.jpg" is found to already exist in the destination folder, the newly scanned paper will be saved as "News clipping_027_2013_01_26_18_00_32.jpg" in which the numeral 2013_01_26_18_00_32 stands for year-month-date-hour-minute-second.

Prompt for confirming file name prefix

Tick the check box to enable the function of **Prompt for confirming file name prefix**. After this function is enabled, the dialog page of **Confirm File Name Prefix** will appear on the screen when you try to scan documents by the **PDF** button of MacAction's Execute Menu. In the page of **Confirm File Name Prefix**, you are able to modify and confirm the saving folder as well as the file name prefix.

Open Finder After Scanning

Tick this check box if you want the program to automatically open the Finder after scanning.

Launch designated application after saving file

- Tick this check box and you can click the **Add** button to add the application. The designated application will be launched after the scanned files are saved. For example, if you add an image-editing application, it will appear after scanning. And you can open the scanned files saved in the destination folder. Then, the scanning results will be viewed and processed in the application.



You are recommended to check existing files in the saving folder before configuring the file name format here, and make sure there are no existing files having the same file name and file extension combination.

2.2.2 File Format Configuration dialog box (for PDF Button Settings)

Within the Button Configuration window click the **PDF** icon on the left pane and then click in the right pane, which opens this dialog box.

The items and parameters available in the window are explained as follows:

Keep the same image quality level for all modes

Ticking this check box will unify the quality level for all scan modes, thus saving you the trouble of adjusting the quality level individually. If you prefer to manually adjust the image quality level for different modes, leave this check box cleared.

Keep the same PDF setting for all modes

Ticking this check box will unify the PDF setting for all scan modes, thus saving you the trouble of individually ticking or clearing the PDF check box. If you prefer different settings for different scan modes, leave this check box cleared.

Configure

Click the **Configure** button to configure [Plustek OCR](#) settings.

Image Quality

For *JPEG* file format, you can set the quality level individually for Color and

- Generate one TIFF/PDF file for all pages: save all the scanned images into one file; or
- Generate one TIFF/PDF file every X pages: save every X pages as a file. You can define the number of pages to be combined in a file.

2.2.2.1 Plustek OCR

You may click **Configure...** to open the PDF Options window where you may adjust image quality for PDF file format.

Convert to PDF/A

Tick this box to convert the PDF file format to PDF/A file format for long-term preservation of electronic documents.

Selected Language

Select the recognition language to read your pages.

2.3 FTP Button Settings

Clicking the **FTP** icon on the left pane in the Button Configuration window displays its current button settings on the right pane.

The settings can be categorized into two: [Session Name and File Saving Settings](#) on the upper part, and [Scan Parameters](#) on the lower part.

The items and parameters available in the window are explained as follows:

Session Name and File Saving Settings

The screenshot shows a configuration window with the following elements:

- Session Name:** A text field containing "Office FTP server" with a dropdown arrow.
- Buttons:** "Add...", "Modify...", "Save Setup...", and "Delete".
- File Format:** A section with three dropdown menus labeled "Color", "Grayscale", and "B/W", each containing "PDF".
- Configure...:** A button located to the right of the File Format section.

More than one FTP session can be added to the drop-down list.

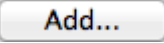
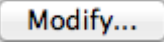
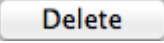
- Clicking  opens the "[FTP Connection Properties](#)" window where you may add frequently-used FTP sessions to the list.
- Clicking  opens the "[FTP Connection Properties](#)" window where you may modify the FTP settings for the current FTP session.
- Clicking  to delete the current FTP session from the list.

Save Setup...

Clicking this button opens the [Save Setup](#) dialog box where you may determine where and in what file name format the scanned documents or images are saved.

File Format

Determines the image file format to save the scanned documents or images to. The following file formats are available from the drop-down list box:

- TIFF - Uncompressed
- BMP
- JPEG
- PNG
- PDF
- MultiplePage TIFF - Compressed

Different file formats can be set for different scan modes. For example, if you usually need color images in JPEG and B/W images in BMP, you may configure so here. Next time when you scan a document in color first and then another document in B/W, you may simply change the [scan parameters](#) without the trouble of changing file formats frequently.

Clicking  opens the [File Format Configuration](#) window where you may configure advanced settings for JPG and PDF file formats.

- [Threshold](#)
- [Color Dropout](#)
- [Descreen](#)
- [Page Rotation Setting](#)
- [Continuous Scan](#)
- [Apply Color Matching](#) (This function may or may not be available depending on the scanner model you purchase.)
- [Auto Density](#)
- [Auto Threshold](#)
- [Auto Crop](#)
- [Multi-Crop](#)
- [Auto Deskew](#)
- [Image Edge Fill](#)
- [Global Settings](#)
- [Preview](#)
- [Default](#)

2.3.1 FTP Connection Properties dialog box

Clicking the **FTP** icon on the left pane in the Button Configuration window displays its current button settings on the right pane. Click or in the right pane, which opens this dialog box.

The items and parameters available in the window are explained as follows:

Session Name

Enter an arbitrary name of the FTP connection, e.g. Office FTP server.

Hostname

or images are saved.

Anonymous connection

Tick this check box to enable Anonymous connection. Otherwise, you have to enter the **Username** and the **Password** for the FTP connection.

Passive Mode

Tick this check box to enable Passive Mode. This option may be necessary to pass firewalls with connection restrictions.

Delete file after transfer complete

Tick this check box to delete the scan images saved in the specified [Saving Folder](#) after the upload transfer is completed.

2.3.2 Save Setup dialog box (for FTP Button Settings)

Within the Button Configuration window click the **FTP** icon on the left pane and then click in the right pane, which opens this dialog box.

The items and parameters available in the window are explained as follows:

Saving Folder

The scanned documents or images are saved to the folder displayed here.

To select or modify the saving folder, click to open a dialog box where you may browse your disk drives to select a desired saving folder. This newly added saving folder will be added to the drop-down menu. Next time when you want to

-immediately after you make any adjustments. The file name extension is automatically added according to the file format you set up.

Date and Time

If you choose to name the saved files in Date and Time format, you may use either option as follows:

Use operating system setting

Files are named according to the date and time setting of the operating system of your computer. You may access System Preferences of your operating system to view or permanently modify your current date and time setting.

User-defined

This setting allows you to customize the date and time naming format for your current need. The data and time setting of your operating system remains unchanged.

Custom

The prefix and the numbering scheme are combined to form the file name. Choose this one if you want to have MacAction automatically save scanned images in a consistent naming and numbering pattern.

Prefix

The text you enter here will become the file name prefix.

Numbering Scheme

The successive numeral will be appended at the end of the file name (right after the prefix). This setting allows you to retain the original page numbers of your paper documents on your digitized image files. The numbering scheme consists of the following criteria:

Start with-- Enter the numeral you want to start with.

Pad-- Click the up/down arrow button to select the number of padded zeroes to insert (from 2-9).

Overwrite the file of the same name

newly scanned paper will be saved as "News clipping_027_2013_01_26_10_03_55.jpg" in which the numeral 2013_01_26_10_03_55 stands for year-month-date-hour-minute-second.

Prompt for confirming file name prefix

Tick the check box to enable the function of **Prompt for confirming file name prefix**. After this function is enabled, the dialog page of **Confirm File Name Prefix** will appear on the screen when you try to scan documents by the **FTP** button of MacAction's Execute Menu. In the page of **Confirm File Name Prefix**, you are able to modify and confirm the saving folder as well as the file name prefix.



You are recommended to check existing files in the saving folder before configuring the file name format here, and make sure there are no existing files having the same file name and file extension combination.

2.4 E-Mail Button Settings

Clicking the **E-Mail** icon on the left pane in the Button Configuration window displays its current button settings on the right pane.

The settings can be categorized into two: [File Saving Settings](#) on the upper part, and [Scan Parameters](#) on the lower part.

The items and parameters available in the window are explained as follows:

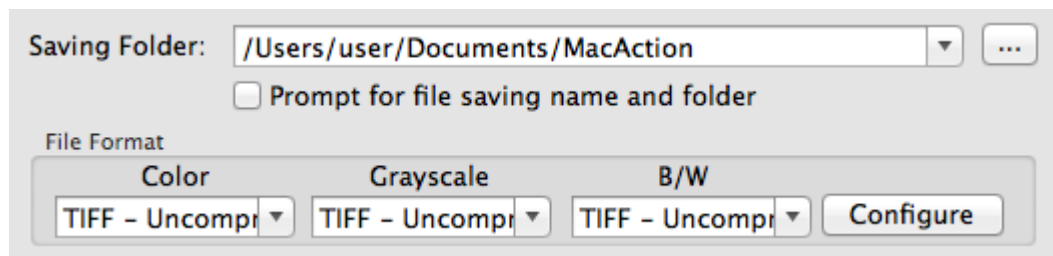

Saving Folder

The scanned documents or images are automatically saved to the folder displayed here.

To select or modify the saving folder, click  to open a dialog box where you may browse your disk drives to select a desired saving folder. This newly added saving folder will be added to the drop-down menu. Next time when you want to use this folder again, you may simply click to select it from this drop-down menu.

MacAction will automatically assign the file name to save the images.

Prompt for file saving name and folder

Tick this check box If you prefer to save each scanned image manually. After the scan of each page finishes, a Save dialog box appears on screen and you may select the folder and file name to save the scanned images individually. This option is useful if you want to save the images scanned in a batch to different folders or in different file naming patterns.

File Format

Determines the image file format to save the scanned documents or images to. The following file formats are available from the drop-down list box:

- TIFF - Uncompressed
- BMP
- JPEG
- PNG

Clicking  opens the [File Format Configuration](#) window where you may configure advanced settings for JPG and PDF file formats.

Scan Parameters

- [Scan Type](#)
 - [Page Size](#)
 - [Scan Mode](#)
 - [Resolution](#)
 - [Brightness](#)
 - [Contrast](#)
 - [Gamma](#)
 - [Threshold](#)
 - [Color Dropout](#)
 - [Descreen](#)
 - [Page Rotation Setting](#)
 - [Continuous Scan](#)
 - [Apply Color Matching](#) (This function may or may not be available depending on the scanner model you purchase.)
 - [Auto Density](#)
 - [Auto Threshold](#)
 - [Auto Crop](#)
 - [Multi-Crop](#)
 - [Auto Deskew](#)
 - [Image Edge Fill](#)
 - [Global Settings](#)
 - [Preview](#)
 - [Default](#)
-

2.5 OCR Button Settings

The items and parameters available in the window are explained as follows:

OCR Settings

Determine to use which OCR application and what settings (e.g., recognition language) to process the scanned images into text file.

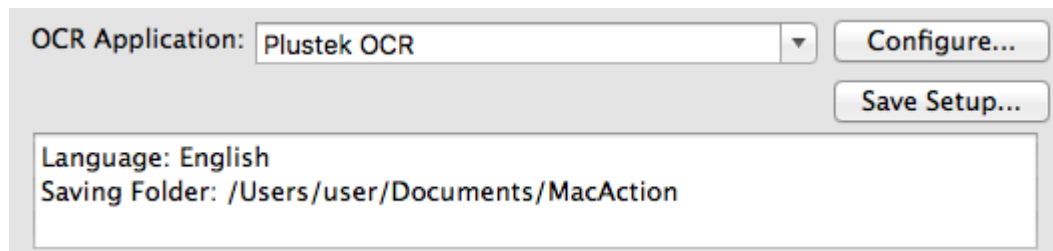

OCR Application

All documents that are scanned are treated by the computer as graphic images. Acting as an image-to-text converter, an OCR (Optical Character Recognition) application program recognizes letters on a page and write them into an editable text file or a text-searchable pdf file.

The options available in the drop-down menu depends on the OCR application programs that you may have installed in your Mac OS. MacAction has been programmed to support the following famous OCR applications in the industry to give you the convenience of single-touch OCR button operation:

- Plustek OCR

The availability of the programs may vary depending on the scanner model you purchase.

Major OCR settings of the selected OCR application are displayed at the bottom. Clicking  opens a configuration window where you may check or modify the OCR settings (e.g., the file format to save the OCR result, recognition language, etc.) as desired.

- [Page Size](#)
 - [Scan Mode](#)
 - [Resolution](#)
 - [Brightness](#)
 - [Contrast](#)
 - [Gamma](#)
 - [Threshold](#)
 - [Color Dropout](#)
 - [Descreen](#)
 - [Page Rotation Setting](#)
 - [Continuous Scan](#)
 - [Apply Color Matching](#) (This function may or may not be available depending on the scanner model you purchase.)
 - [Auto Density](#)
 - [Auto Threshold](#)
 - [Auto Crop](#)
 - [Multi-Crop](#)
 - [Auto Deskew](#)
 - [Image Edge Fill](#)
 - [Global Settings](#)
 - [Preview](#)
 - [Default](#)
-

Also see:

 [Plustek OCR Configuration](#)

2.5.1 Plustek OCR Configuration

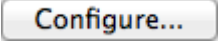
If you select Plustek OCR as the OCR application, clicking  opens the Plustek OCR window. The items and parameters available in this window are explained as follows:

where you may adjust image quality for PDF file format.

Convert to PDF/A

Tick this box to convert the PDF file format to PDF/A file format for long-term preservation of electronic documents.

Selected Language

Select the recognition language to read your pages.

2.5.2 Save Setup dialog box (for OCR Button Settings)

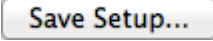
Within the Button Configuration window click the **OCR** icon on the left pane and then click  in the right pane, which opens this dialog box.

The items and parameters available in the window are explained as follows:

Saving Folder

The scanned documents or images are saved to the folder displayed here.

To select or modify the saving folder, click  to open a dialog box where you may browse your disk drives to select a desired saving folder. This newly added saving folder will be added to the drop-down menu. Next time when you want to use this folder again, you may simply click to select it from this drop-down menu.

File Name

You are allowed to name the saved files in two ways:

- using the "Date and Time" format; or
- using customized prefix and numbering scheme.

Files are named according to the date and time setting of the operating system of your computer. You may access System Preferences of your operating system to view or permanently modify your current date and time setting.

User-defined

This setting allows you to customize the date and time naming format for your current need. The data and time setting of your operating system remains unchanged.

Custom

The prefix and the numbering scheme are combined to form the file name. Choose this one if you want to have MacAction automatically save scanned images in a consistent naming and numbering pattern.

Prefix

The text you enter here will become the file name prefix.

Numbering Scheme

The successive numeral will be appended at the end of the file name (right after the prefix). This setting allows you to retain the original page numbers of your paper documents on your digitized image files. The numbering scheme consists of the following criteria:

Start with-- Enter the numeral you want to start with.

Pad-- Click the up/down arrow button to select the number of padded zeroes to insert (from 2-9).

Overwrite the file of the same name

What if a file with the same file name and file extension combination happens to already exist in the assigned saving folder? MacAction offers you two options as follows:

- Tick this check box and have MacAction overwrite the existing file with the newly-scanned image.
- Clear this check box and have MacAction not only save the newly-scanned image to file according to your customized prefix and numbering scheme but also append the date and time of your operating

File Name Prefix will appear on the screen when you try to scan documents by the **OCR** button of MacAction's Execute Menu. In the page of **Confirm File Name Prefix**, you are able to modify and confirm the saving folder as well as the file name prefix.



You are recommended to check existing files in the saving folder before configuring the file name format here, and make sure there are no existing files having the same file name and file extension combination.

Open Finder After Scanning

Tick this check box if you want the program to automatically open the Finder after scanning.

2.6 File Button Settings

Clicking the **File** icon on the left pane in the Button Configuration window displays its current button settings on the right pane.

The settings can be categorized into two: [File Saving Settings](#) on the upper part, and [Scan Parameters](#) on the lower part.

The items and parameters available in the window are explained as follows:

Saving Folder

The scanned documents or images are automatically saved to the folder displayed here.

To select or modify the saving folder, click  to open a dialog box where you may browse your disk drives to select a desired saving folder. This newly added saving folder will be added to the drop-down menu. Next time when you want to use this folder again, you may simply click to select it from this drop-down menu.

File Name

Specifies the file name format to save scanned documents or images. The file name extension is automatically added according to the file format you set up.

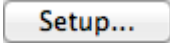
The current file name format is displayed in the white rectangle. To change to a different format, click  to open the [File Name Setup](#) window.

File Format

Determines the image file format to save the scanned documents or images to. The following file formats are available from the drop-down list box:

- TIFF - Uncompressed
- BMP
- JPEG
- PNG
- PDF
- MultiplePage TIFF - Compressed

Different file formats can be set for different scan modes. For example, if you usually need color images in JPEG and B/W images in BMP, you may configure so here. Next time when you scan a document in color first and then another document in B/W, you may simply change the [scan parameters](#) without the trouble of changing file formats frequently.

- [Resolution](#)
- [Brightness](#)
- [Contrast](#)
- [Gamma](#)
- [Threshold](#)
- [Color Dropout](#)
- [Descreen](#)
- [Page Rotation Setting](#)
- [Continuous Scan](#)
- [Apply Color Matching](#) (This function may or may not be available depending on the scanner model you purchase.)
- [Auto Density](#)
- [Auto Threshold](#)
- [Auto Crop](#)
- [Multi-Crop](#)
- [Auto Deskew](#)
- [Image Edge Fill](#)
- [Global Settings](#)
- [Preview](#)
- [Default](#)

2.6.1 File Name Setup dialog box (for File Button Settings)

You are allowed to name the saved files in two ways:

- using the "Date and Time" format; or
- using customized prefix and numbering scheme.

You can see the file naming example on screen--near the bottom of this dialog box-

Use operating system setting

Files are named according to the date and time setting of the operating system of your computer. You may access System Preferences of your operating system to view or permanently modify your current date and time setting.

User-defined

This setting allows you to customize the date and time naming format for your current need. The data and time setting of your operating system remains unchanged.

Custom

The prefix and the numbering scheme are combined to form the file name. Choose this one if you want to have MacAction automatically save scanned images in a consistent naming and numbering pattern.

Prefix

The text you enter here will become the file name prefix.

Numbering Scheme

The successive numeral will be appended at the end of the file name (right after the prefix). This setting allows you to retain the original page numbers of your paper documents on your digitized image files. The numbering scheme consists of the following criteria:

Start with-- Enter the numeral you want to start with.

Pad-- Click the up/down arrow button to select the number of padded zeroes to insert (from 2-9).

Overwrite the file of the same name

What if a file with the same file name and file extension combination happens to already exist in the assigned saving folder? MacAction offers you two options as follows:



- Tick this check box and have MacAction overwrite the existing file with the newly-scanned image.
- Clear this check box and have MacAction not only save the newly-scanned image to file according to your customized prefix and

prefix. After this function is enabled, the dialog page of **Confirm File Name Prefix** will appear on the screen when you try to scan documents by the **File** button of MacAction's Execute Menu. In the page of **Confirm File Name Prefix**, you are able to modify and confirm the saving folder as well as the file name prefix.

Open Finder After Scanning

Tick this check box if you want the program to automatically open the Finder after scanning.

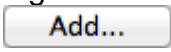
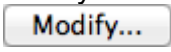
Launch designated application after saving file

- Tick this check box and you can click the **Add** button to add the application. The designated application will be launched after the scanned files are saved. For example, if you add an image-editing application, it will appear after scanning. And you can open the scanned files saved in the destination folder. Then, the scanning results will be viewed and processed in the application.
- Clear this check box , the application won't be launched after saving files. Up to 10 programs can be added to Application's drop-down menu.
- Clicking  opens the "[Add/Modify Linked Application](#)" window where you may add frequently-used programs to the Application menu.
- Clicking  opens the "[Add/Modify Linked Application](#)" window where you modify the name, memo and command line for the current application.
- Clicking  to delete the current application link from the Application menu.



You are recommended to check existing files in the saving folder before configuring the file name format here, and make sure there are no existing files having the same file name and file extension combination.

2.7 Copy Button Settings

Printing Settings

Because all printers have their own printing characteristics and no two printers will give the exact same output (especially where colors and images are concerned), this Button Configuration window provides a number of options or settings, allowing you to adjust the scanning process to tailor the output to your particular printer. You will need to experiment with the settings to optimize the quality of the printed image.

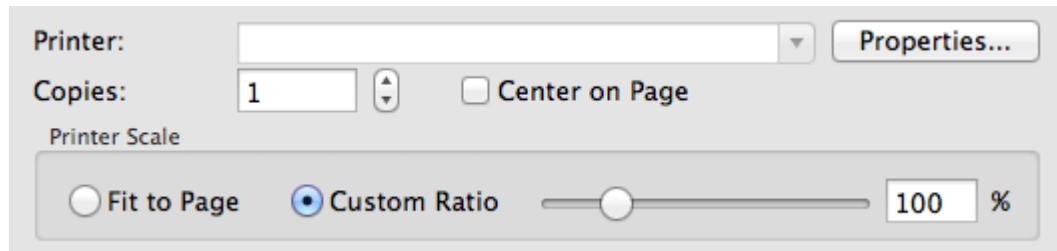

Printer

All printers that are currently installed in Mac OS are displayed in the drop-down menu.

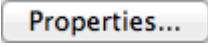
If needed, click  to configure the printer.

Copies

This setting decides the number of copies to be printed. Do one of the following:

- Enter the numeral in the edit box directly; or
- Click  to increase/decrease the number.

Center on Page

If the check box is ticked, the image will be centered in the printable area of the selected paper.

Fit to Page

If this option is selected, the print size of the image will be re-scaled to fit within

Scan Parameters

- [Scan Type](#)
 - [Page Size](#)
 - [Scan Mode](#)
 - [Brightness](#)
 - [Contrast](#)
 - [Gamma](#)
 - [Threshold](#)
 - [Color Dropout](#)
 - [Descreen](#)
 - [Page Rotation Setting](#)
 - [Continuous Scan](#)
 - [Apply Color Matching](#) (This function may or may not be available depending on the scanner model you purchase.)
 - [Auto Density](#)
 - [Auto Threshold](#)
 - [Auto Crop](#)
 - [Multi-Crop](#)
 - [Auto Deskew](#)
 - [Image Edge Fill](#)
 - [Global Settings](#)
 - [Preview](#)
 - [Default](#)
-

2.8 Scan Button Settings

Clicking the **Scan** icon on the left pane in the Button Configuration window displays its current button settings on the right pane.

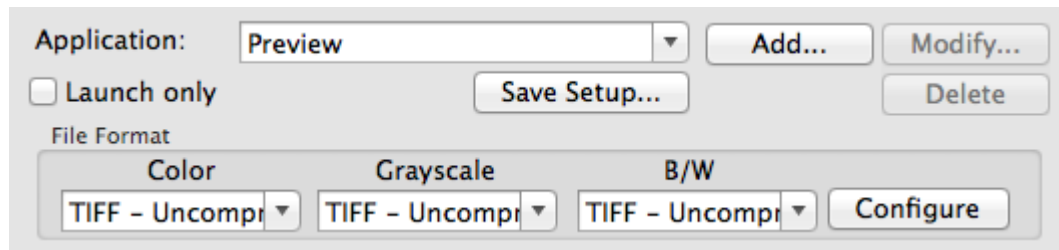

Application



Specifies an application program to be launched and linked to the Scan button. After the scan is complete, this application program is started up automatically and displays all scanned images.



Make sure you select an application that can process the specified file format. Scanned images cannot be displayed properly if the specified file format is not supported by that application.

For example, if you select file format as JPEG, PNG, BMP or TIFF (compressed or uncompressed), make sure you select an *image-editing* application; if you select PDF to save the scanned images, you are recommended to select Adobe Acrobat or Adobe Acrobat Reader that has been installed in your Mac OS.

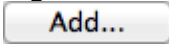
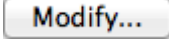
Up to 10 programs can be added to Application's drop-down menu.

- Clicking  opens the "[Add/Modify Linked Application](#)" window where you may add frequently-used programs to the Application menu.
- Clicking  opens the "[Add/Modify Linked Application](#)" window where you modify the name, memo and command line for the current application.
- Clicking  to delete the current application link from the Application menu.

Launch only

images are saved.

File Format

Determines the image file format to save the scanned documents or images to. The following file formats are available from the drop-down list box:

- TIFF - Uncompressed
- BMP
- JPEG
- PNG
- PDF
- MultiplePage TIFF - Compressed

Different file formats can be set for different scan modes. For example, if you usually need color images in JPEG and B/W images in BMP, you may configure so here. Next time when you scan a document in color first and then another document in B/W, you may simply change the [scan parameters](#) without the trouble of changing file formats frequently.

Clicking  opens the [File Format Configuration](#) window where you may configure advanced settings for JPG and PDF file formats.

Scan Parameters

- [Scan Type](#)
- [Page Size](#)
- [Scan Mode](#)
- [Resolution](#)
- [Brightness](#)
- [Contrast](#)
- [Gamma](#)
- [Threshold](#)
- [Color Dropout](#)

- [Auto Deskew](#)
 - [Image Edge Fill](#)
 - [Global Settings](#)
 - [Preview](#)
 - [Default](#)
-

2.8.1 Add/Modify Linked Application dialog box

Within the Button Configuration window click the **Scan** icon on the left pane and then click or in the right pane, which opens this dialog box.

The items and parameters available in the window are explained as follows:

Application

Click to browse to the desired program folder and select the executable file (*.exe) of the desired application program. The application is displayed here with its full file path and execution file name.

Name

Enter the name for the newly-added application program. The name can be short like a nickname or even in more words including complete software name and its vendor name; that is, write anything that can help you recognize this linked application.

This name will be displayed in the Application's drop-down menu in the Button Configuration window.

the command line.

2.8.2 Save Setup dialog box (for Scan Button Settings)

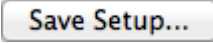
Within the Button Configuration window click the **Scan** icon on the left pane and then click  in the right pane, which opens this dialog box.

The items and parameters available in the window are explained as follows:

Saving Folder

The scanned documents or images are saved to the folder displayed here.

To select or modify the saving folder, click  to open a dialog box where you may browse your disk drives to select a desired saving folder. This newly added saving folder will be added to the drop-down menu. Next time when you want to use this folder again, you may simply click to select it from this drop-down menu.

File Name

You are allowed to name the saved files in two ways:

- using the "Date and Time" format; or
- using customized prefix and numbering scheme.

You can see the file naming example on screen--near the bottom of this dialog box--immediately after you make any adjustments. The file name extension is automatically added according to the file format you set up.

Date and Time

If you choose to name the saved files in Date and Time format, you may use either option as follows:

Use operating system setting

Custom

The prefix and the numbering scheme are combined to form the file name. Choose this one if you want to have MacAction automatically save scanned images in a consistent naming and numbering pattern.

Prefix

The text you enter here will become the file name prefix.

Numbering Scheme

The successive numeral will be appended at the end of the file name (right after the prefix). This setting allows you to retain the original page numbers of your paper documents on your digitized image files. The numbering scheme consists of the following criteria:

Start with-- Enter the numeral you want to start with.

Pad-- Click the up/down arrow button to select the number of padded zeroes to insert (from 2-9).

Overwrite the file of the same name

What if a file with the same file name and file extension combination happens to already exist in the assigned saving folder? MacAction offers you two options as follows:

- Tick this check box and have MacAction overwrite the existing file with the newly-scanned image.
- Clear this check box and have MacAction not only save the newly-scanned image to file according to your customized prefix and numbering scheme but also append the date and time of your operating system at the end of the file name. For example, if the file "News clipping_027.jpg" is found to already exist in the destination folder, the newly scanned paper will be saved as "News clipping_027_2013_01_26_10_03_55.jpg" in which the numeral 2013_01_26_10_03_55 stands for year-month-date-hour-minute-second.

Prompt for confirming file name prefix

Tick the check box to enable the function of **Prompt for confirming file name prefix**. After this function is enabled, the dialog page of **Confirm**

Open Finder After Scanning

Tick this check box if you want the program to automatically open the Finder after scanning.

2.9 Common Scan Parameters

The following describes the scan parameters available to every button setting window:

The screenshot displays a configuration window for a scanner. The parameters are organized into several sections:

- Scan Type:** A dropdown menu set to "Flatbed".
- Page Rotation Setting:** A sub-panel containing "Front Side: 0°" and "Rear Side: 0°" with a "Configure" button.
- Page Size:** A dropdown menu set to "Max. Scan Area".
- Scan Mode:** A dropdown menu set to "Color".
- Resolution:** A dropdown menu set to "150" with a corresponding input field.
- Brightness:** A slider set to "0".
- Contrast:** A slider set to "0".
- Gamma:** A slider set to "1.00".
- Threshold:** A slider set to "128".
- Color Dropout:** A dropdown menu set to "None".
- Descreen:** A dropdown menu set to "None".
- Checkboxes:** A list of options including "Merge Pages" (checked), "Manual Merging Adjustment", "Horizontally" (radio), "Vertically" (radio), "Continuous Scan", "Apply Color Matching", "Auto Density", "Auto Threshold", "Auto Crop" (checked), "Multi-Crop", "Auto Deskew", "Remove Blank Pages", and "Image Edge Fill".
- Buttons:** "Preview" and "Default" buttons at the bottom right.

Scan Type

Tells the scanner the method you will use to scan documents or images. The

Name:

Give a name to this customized page size. After you configure the page size and click the **OK** button, this name will appear in the **Page Size** drop-down list.

Unit:

Defines the measurement unit for the page size.

Width, Height:

Specifies the exact width and height of the page area.

Paper Alignment:

This setting tells the scanner how you place the document into the scanner.

When **Flatbed** is selected as the Scan Type:

- **Upper Left:** Place a document face down onto the scanner glass and align the document top with the arrow on the reference mark.
- **Center:** Align the center top of the document with the center of scanner glass's right side.



This setting works well only if you always place the page in the same place on the scanner flatbed.

Scan Mode

Tells the scanner what type of documents you are scanning. The following options are available from the drop-down menu:

- **Black & White**-- scans in black and white and is suitable for scanning text.
- **Grayscale**-- scans in 256 shades of gray, giving black and white images depth and shadow.
- **Color**-- scans in millions of colors but takes up a lot of memory.

Resolution

| Document to be scanned | Resolution (dpi) |
|-------------------------------|------------------|
| Text (for printing) | 300 |
| Text (for faxing) | 200 |
| Text (for OCR) | 300 |
| Black and white or gray image | 150 |
| Color image or photo | 100 |



- These values are only recommendations and should be raised if the resulting image is rough or you need to view fine details.
- To scan a large-size color image with a higher resolution (usually over 600 dpi) increases scan time and file size substantially and requires huge system resources. Therefore, a higher resolution for color scanning is recommended only when you scan a small area.

Brightness

Raising the brightness increases the amount of white in an image, making it appear more washed out. Lowering the brightness may help you read light or faint text.

You may adjust the brightness either way:

- Slide the thumb of the scroll bar to the right or left, which adds lightness or darkness to all colors in your image.
- Click on the scroll bar.

The current value is shown to right of each scroll bar.

Contrast

The higher the contrast, the sharper the image. The lower the contrast, the more blurry an image will be.

Gamma

Image Gamma is used to adjust the colors in the image that will be scanned into the computer. Gamma values are primarily a measure of the brightness of a color. The larger the gamma value, the brighter the color becomes.

Do one of the following:

- Slide the thumb of the scroll bar to the right or left.
- Click on the scroll bar.

The current value is shown to right of the scroll bar.

This feature is not available when **Black & White** is selected as Scan Mode.

Threshold

Threshold sets the color level for converting an image to line art, which can adjust the quality of line art image or eliminate unwanted dots in the documents to improve OCR accuracy. This setting is available only when **Black & White** is selected as Scan Mode.

You may adjust the Threshold value either way:

- Slide the thumb of the scroll bar to the right or left to decrease or increase the Threshold value.
- Click on the scroll bar.

The current value is shown to right of the scroll bar.





Color Dropout

Color Dropout allows you to remove a color channel (Red, Green or Blue) while scanning. This feature is available only when **Black & White** or **Grayscale** is selected as Scan Mode.

For example, if your original document contains blue texts or a blue stamp (e.g., a bill or invoice) and you want to discard it from your image, you may select **Blue Channel** from the drop-down list box

Page Rotation Setting

Clicking opens the **Page Rotation Setting** page.

-  **0°**-- Clicking this button keeps the image at its original orientation.
-  **90° Right**-- Clicking this button turns the image clockwise by 90°.
-  **180°**-- Clicking this button turns the image by 180°.
-  **90° Left**-- Clicking this button turns the image counterclockwise by 90°.

Continuous Scan

Check this option if you want to scan multiple pages successively to the same destination. After the document is scanned, a dialog will pop up asking you if you will put in more paper to continue scanning, or if you want to end the scan.

Apply Color Matching (This function may or may not be available depending on the scanner model you purchase.)

Different types of devices reproduce different ranges of colors (or color gamut). For example, you may have noticed the colors of the scanned image displayed on your monitor and on the paper printed from your printer are different.

Color Matching allows you to get consistent color between input and output devices (e.g., scanner, monitor, printer). It works by embedding a color profile to your image files. Each different device displays colors according to this profile and therefore results in consistent color appearance among all devices.

Ticking this check box if you want MacAction to apply the built-in color sRGB profile to the scanned images. This feature is available only when **Color** is selected as Scan Mode.

This feature is not available when **Black & White** is selected as Scan Mode.

Auto Threshold

Ticking this check box will have MacAction apply optimal threshold value to your scanned images.

This setting is available only when **Black & White** is selected as Scan Mode.

Auto Crop

Alternatively you may tick this check box to have MacAction automatically identify the dimensions of the image you scanned and crop around the edges. The crop shape will be a square or rectangle and it will not trace the edges of oddly-shaped images. This command can be useful when scanning smaller images such as photographs.

Multi-Crop



When you scan two or more small items at the same time using the flatbed scanner, you may tick this check box to perform multi-crop automatically. The program will identify each individual item and generate separate scanned image files. The scanned items must be placed separately and no two items are sticking together on the scanner glass. Place all small items on the scanner's flatbed with a slight gap between them for best scanning results.



Auto Deskew

Tick this check box if you want MacAction to automatically straighten the skewed image after auto crop is done.

If the placed image is too slanted ($>10^\circ$), the Auto Deskew function will not recognize the skewed image(s).

Image Edge Fill

When you scan by the **Grayscale Mode**, you may click  button for white edge fill or  button for black edge fill.

When you scan by the **BW mode**, you may click  button for white edge fill or  button for black edge fill.

Tick the check box of **All sides match**, the widths of four sides would be set to be the same. You may adjust the width by clicking  buttons. If you do not tick this check box, then you can adjust the width of each side individually.

Preview

By clicking on the Preview button, you can scan the source document into the preview window within MacAction interface. Documents or images that are previewed will be displayed here. The previewed image gives you an idea of how a document or image will look after it is scanned.

Default

Clicking the Default button on the lower right corner revert the settings to its original values and discard all adjustments you have made.

2.10 File Format Configuration dialog box

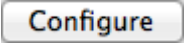
Within the Button Configuration window click the **File**, **Scan**, **FTP** or **E-Mail** icon on the left pane and then click  in the right pane, which opens this dialog box.

The items and parameters available in the window are explained as follows:

different settings for different scan modes, leave this check box cleared.

Image Quality

For *JPEG* file format, you can set the quality level individually for Color and Grayscale scan modes.

You can adjust the quality value from 1 to 100. The higher the quality setting, the more detail is preserved, but a larger file size it would take. The smaller the image file, the lower quality the image has, but the less disk space it takes. The balance of image quality and file size needs to be determined according to your own needs.

If TIFF/PDF is chosen as the file format, you have two options to save the scanned images:

- Generate one TIFF/PDF file for all pages: save all the scanned images into one file; or
- Generate one TIFF/PDF file every X pages: save every X pages as a file. You can define the number of pages to be combined in a file.

3 Using the Scanner Buttons

Conditions for buttons to work properly

The following conditions are required for the scanner buttons and MacAction to work properly.

- **Scan:** An application program must be selected to link with the Scan button.
- **Copy:** A printer must be connected and the printer driver has been correctly installed in Mac OS.
- **FTP:** A FTP server must be correctly configured to connect with your scanner and your computer.



3.1 Configure Button Settings









Refer to the "Preparing Documents" section of the Scanner User's Guide to choose an appropriate method to scan your paper documents.

3.1.1 How to Configure Button Settings

Within the "Button Configuration" window, you can find a row of icons running through the left side of the window. Each icon represents a scanning task, and the number underneath corresponds to the function number displayed on the scanner panel. Seven frequently-used scanning tasks are pre-configured for your convenience to start scanning immediately. You may, however, customize the settings of every seven tasks to best meet your needs and preferences.

1. Do one of the following to open the Button Configuration window:
 - Double-click the icon  in **Finder > Applications > Plustek > Your scanner model name**.
 - Click the icon  in the Dock.
 - Right-click the icon  in the Dock, and then choose **Button Configuration...** in the pop-up menu that opens.
2. When the Button Configuration window appears, click any icon in the left pane.
3. Select the desired function from the drop-down list of Button Template.
4. Enter your personal memo in the Description field.
5. Adjust particular settings related to that button function.

-  [OCR Button Settings](#)
-  [File Button Settings](#)
-  [Scan Button Settings](#)
-  [Copy Button Settings](#)
-  [E-Mail Button Settings](#)
-  [PDF Button Settings](#)
-  [FTP Button Settings](#)

3.2 Scan from the Buttons

Scanning documents or images from this scanner is very easy. Follow the two steps described below:

1. Place the document or images onto the scanner. (Refer to the Scanner User's Guide for more information in placing paper on the flatbed glass properly.)



Place only *text documents* for OCR purposes. Do not scan a photo using the OCR button.





2. Do one of the following to start scanning:
 - Press the button from the scanner's panel.
 - Right-click the icon  in the Dock, and then choose **Execute** in the pop-up menu that opens. Click the desired button function item in the pop-up menu.

The scanner starts to scan immediately and carry out the corresponding action according to settings you have set up in the Button Configuration window.

Also see:

3.3 How to create searchable PDF documents by MacAction program?

Scan from the PDF Button

1. Do one of the following to open the Button Configuration window:
 - Double-click the icon  in **Finder > Applications > Plustek > Your scanner model name**.
 - Click the icon  in the Dock.
 - Right-click the icon  in the Dock, and then choose **Button Configuration...** in the pop-up menu that opens.
2. When the Button Configuration window appears, click any button on the left pane. Select PDF Utility from the drop-down list of Button Template. Enter your personal memo in the Description field.
3. Select Searchable PDF from the drop-down list of File Format (Color, Grayscale, B/W).
4. Check the scan settings and make any required changes.
5. After all settings are done, click to accept the settings and exit this Button Configuration window, or click to save what you have configured and continue adjusting other settings.
6. Right-click the icon  in the Dock, and then choose **Execute** in the pop-up menu that opens.
7. Click the configured PDF button function in the pop-up menu.

Scan from the OCR Button

- When the Button Configuration window appears, click any button on the left pane. Select OCR Utility from the drop-down list of Button Template. Enter your personal memo in the Description field.
- Select an OCR application to convert the scanned images into characters readable by your word processor or text viewer. The availability of the programs may vary depending on the scanner model you purchase.

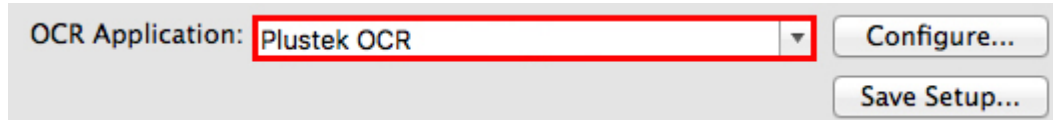

A screenshot of a software interface showing the 'OCR Application' selection. A dropdown menu is open, displaying 'Plustek OCR' which is highlighted with a red rectangular box. To the right of the dropdown are two buttons: 'Configure...' and 'Save Setup...'.

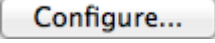
- Clicking  opens a configuration window for the selected OCR application.

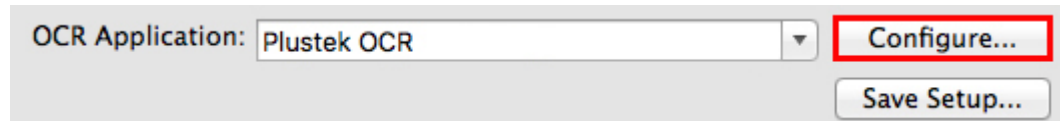

A screenshot of the configuration window for the selected OCR application. The 'OCR Application' dropdown menu shows 'Plustek OCR'. The 'Configure...' button is highlighted with a red rectangular box. The 'Save Setup...' button is visible below it.

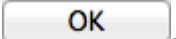
- Select Searchable PDF from the drop-down list of File Format and click .

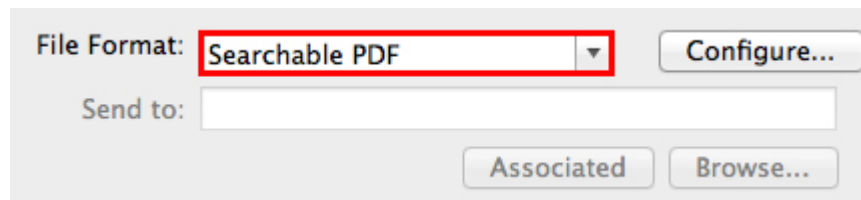

A screenshot of a software interface showing the 'File Format' selection. A dropdown menu is open, displaying 'Searchable PDF' which is highlighted with a red rectangular box. To the right of the dropdown is a 'Configure...' button. Below the dropdown is a 'Send to:' text field. At the bottom are two buttons: 'Associated' and 'Browse...'.

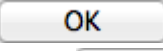
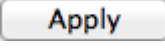
- Check the scan settings and make any required changes.
- After all settings are done, click  to accept the settings and exit this Button Configuration window, or click  to save what you have configured and continue adjusting other settings.