

...easy operation with the ProHome app



OLYMPIA

ProHome series Base unit

Operating manual





Hello,

We are delighted that you have decided to purchase this reliable device from Olympia.

The descriptions on the following pages will explain how easy it is to make your home more safe and secure.



Inhalt

Before You Start	6
Safety Instructions	7
Intended Use	9
Scope of Delivery	9
Overview of Base Unit	10
Front	10
Rear	11
Display	12
Keys and Operating Elements	13
Control Lamps	14
Overview of Remote Control	14
Menu Structure	15
Putting the Base Unit into Operation ...	16
Positioning the Base Unit	16
Inserting the SIM Card (Option)	17
Inserting the Batteries (Option)	18
Connecting the Power Adapter	19

Setting Up the Base Unit	20
Setting the Key Lock	20
Setting the Language	21
Setting the Time and Date	21
Registering Sensors	22
Deregistering Sensors	23
Renaming Sensors	23
Individual Voice Message	23
Configuring the Telephone Unit	24
Saving Alarm Call Numbers	25
Saving an SOS (Emergency Call) Number ...	26
Testing the Telephone Unit	26
Setting the Trigger Delay	27
Setting the Arming Delay	28
Setting the Alarm Period	28
Switching the Warning Signal from the Base Unit On/Off	28
Setting the Key Tone	29
Setting the Volume of the Voice Output ...	29
Setting the Contrast	29



Monitoring Functions	30
Alarm Mode	31
At Home Mode	31
Silent Mode	32
Disarmed Mode	32
Panic Alarm	33
Emergency call (SOS)	33
PIR At Home mode	34
Smoke and Water Detectors	35
Function of the  Key	35
Installing the ProHome App	36
Setting up the Base Unit with the ProHome app	36

Appendix	43
Updating Firmware	43
Resetting WiFi Settings	44
Switching WiFi off/on	44
Restoring the Default Factory Settings	45
Changing the Battery	45
Technical Data - Base Unit	46
Technical Data - Remote Control	46
System Extensions	46
Cleaning and Service	47
Information on Disposal	47
Guarantee	47
Information on Conformity	47



Before You Start

The alarm system is a passive security product and has been conceived as a deterrent. Additional measures are necessary to prevent and hinder burglary and theft.

You can obtain all the necessary information on this from your local police station.

You can increase security by integrating additional sensors from the Olympia range. We also provide outdoor sirens, door/window contacts, motion detectors, vibration sensors, water detectors, glass breakage detectors and much more.

You can find more information about making your home safe on our website **www.olympia-prohome.de**



Read the operating manual thoroughly and observe all the information contained when using the alarm system. Keep the operating manual in a safe place for future reference.



Pay attention to this symbol. Texts which are highlighted by this symbol provide helpful information on handling the alarm system.





Safety Instructions

The following warnings apply to the entire document. Read and observe all the warnings to protect yourself and the environment from any harm.

The following warnings indicate potentially dangerous situations which could lead to serious injuries or even fatal injuries if the information is ignored.

 **WARNING!** Risk of fatal injury from electric shock! NEVER use the device if you suspect damage to the power cable or power plug or there are visible signs of damage to the power cable or power plug.

 **NEVER** complete any repairs to the device yourself. Never open the device because it contains no components which you may service yourself. In the event of a fault, contact our Service Department.

 **WARNING!** Risk of suffocation! Children can swallow small parts, packaging and protective foils. Keep the device and packaging out of reach of children.



WARNING! Risks to health through batteries! Keep batteries out of reach of children. Do not swallow batteries. If any type of battery or round cell is swallowed, seek medical attention immediately.



WARNING! Risk of explosion! Improper storage of batteries can put your health and the environment at risk. Batteries may contain toxic, ecologically hazardous heavy metals. Never open, damage or swallow batteries or allow them to pollute the environment.



SAFETY INSTRUCTIONS

The following warnings indicate potentially dangerous situations which could lead to minor or slight injuries if the information is ignored.



CAUTION! This device can be used by children from the age of 8 and persons with restricted physical, sensory or mental capabilities or a lack of experience and knowledge as long as they are supervised or have been instructed with regard to safe use of the device and are aware of the potential risks involved with its use. Children must never play with the device. Cleaning and user maintenance may not be completed by children without any supervision.



CAUTION! Hearing damage through loud alarm signal! Due to legal requirements, the alarm signal continues for maximally 120 seconds. The alarm signal switches off automatically after about 120 seconds if the user does not interrupt it. Use ear protectors when testing the device. Do not remain in the vicinity of the acoustic alarm for a longer period when it has been triggered.

The following warnings indicate potentially dangerous situations which could lead to property damage if the information is ignored.



ATTENTION! Risk of property damage through the use of inappropriate batteries! The use of inappropriate batteries can cause a loss of function of the device. Only use the batteries supplied or those of the type described in Section "Technical Data".



ATTENTION! Risk of property damage through environmental influences! Prevent environmental influences such as exposure to smoke, dust, vibration, chemicals, moisture, heat and direct sunlight.



Intended Use

The alarm system in the ProHome series is suitable for monitoring rooms and houses, as long as there is a reliable wireless connection to the registered sensors (e.g. door/window contacts, smoke detectors).

A condition for complying with the intended use is that the equipment is installed correctly and the information in the manual is observed and maintained.

Any other use is considered unintended use.

This operating instruction manual contains important information on setting up and handling the equipment. Always hand over this operating manual if the alarm system is transferred to others.

Scope of Delivery

Please check the contents of the package carefully. If anything is missing or has been damaged during transport, DO NOT put the alarm system into operation! Keep the packaging in a safe place to protect the equipment from damage should it need to be dispatched in future.

Base unit

Power adapter

Remote control

Batteries	3 x alkaline batteries, AAA, 1.5 V 1 x round cell battery, CR2032
------------------	--

Assembly material	Base unit legs, screws, dowels
--------------------------	--------------------------------

Operating manual



Overview of Base Unit

Front



1 Display

2 Loudspeaker

3 Control Lamps

4 Function keys

5 Digit keys



Rear

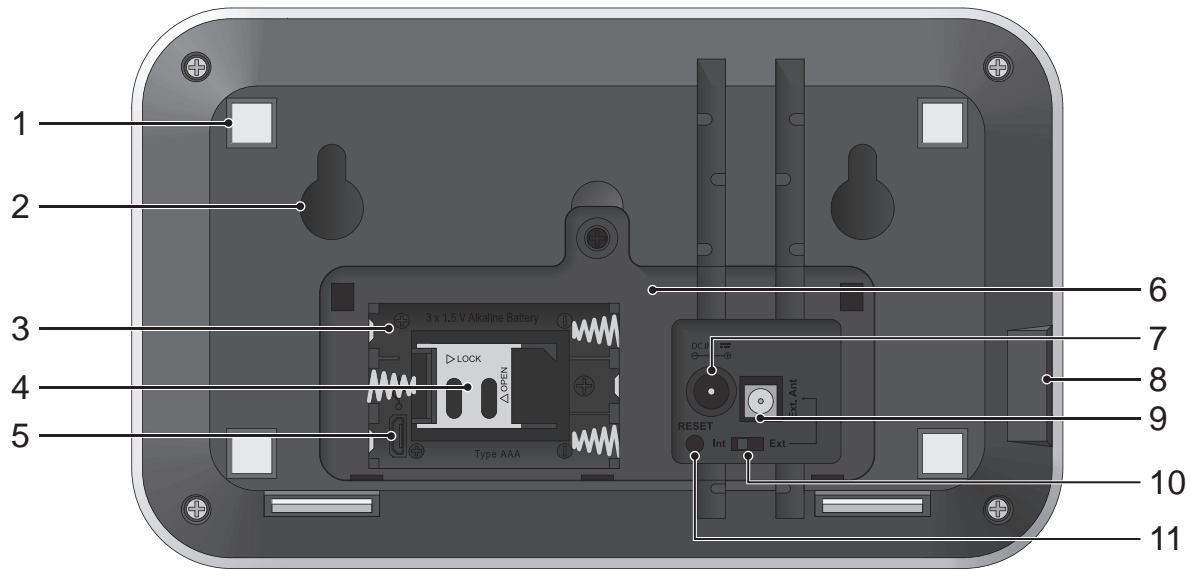

1	Rubberised base unit legs	7	Connection port for power adapter
2	Recesses for mounting bracket	8	USB interface (only for service)
3	Battery compartment	9	Connection for external antenna (option)
4	Compartment for SIM card	10	Antenna switch
5	MicroUSB connection port	11	Reset key
6	Battery compartment cover		



Display

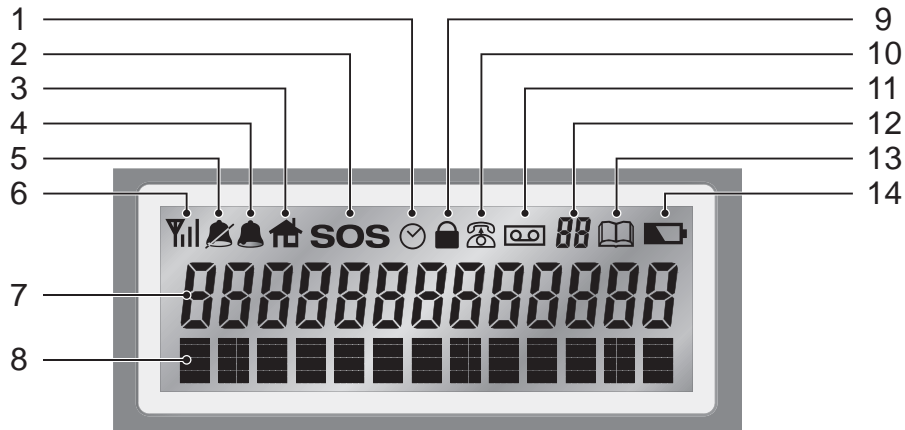











1	Delay activated (arming, triggering, key lock)	8	More information in plain text (e.g. Register)
2	Telephone unit activated for emergency call (SOS)	9	Key lock activated
3	At Home mode activated	10	Telephone unit activated
4	Alarm mode activated	11	Recorded message playing
5	Silent mode activated	12	Storage location of phone number
6	Display of the network availability	13	Save icon
7	Display for plain text (e.g. 19:09)	14	Base unit battery is almost empty



Keys and Operating Elements

The following table indicates the functions assigned to the individual keys and operating elements on the front of the base unit of the alarm system.

 SOS	SOS key	 ESC	Disarmed mode key; exit the menu; stop the countdown
 OK	Confirm entries		Silent mode key; delete input
	Panic key		Alarm mode key
	Open the menu; navigate in the menu; increase the loudspeaker volume in Handsfree mode		At Home mode key
	Open Save mode for alarm phone numbers; navigate in the menu; reduce the loudspeaker volume in Handsfree mode		Digit keys to enter your settings
			



Control Lamps

The following table indicates the flashing and light-up behaviour of the control lamps on the front of the base unit of the alarm system.

Operation via power adapter				
Centre LED		Bottom LED		
Silent Mode	Lights up	Flashing		
Alarm Mode	Flashing	Off		
At Home Mode	Lights up	Lights up		
Disarmed Mode	Lights up	Off		
Operation with batteries				
Centre LED		Bottom LED		
Silent Mode	Off	Flashing		
Alarm Mode	Flashing	Off		
At Home Mode	Off	Lights up		
Disarmed Mode	Off	Off		
Top LED				
Searching for network	Flashing			
Connected to network	Lights up			

Overview of Remote Control

The remote control enables you to switch monitoring functions on and off, trigger a Panic alarm or make an emergency call via the base unit of the alarm system.

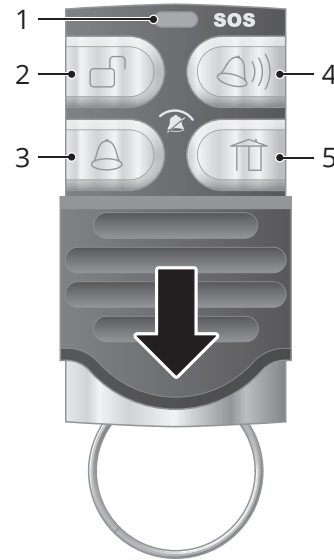

- 1 Lamp indicator
- 2 Disarm key
- 3 Alarm key
- 4 Panic key /
Emergency call key
- 5 At Home key



Menu Structure

 (Open the menu)

Review	
Register	
Entry Code	
KeyLock Delay	
Date/Time	
Check SIM \$	
Alarm Setup	Trigger Delay
	Trigger Tone <i>On</i>
	<i>Off</i>
	Arming Delay
	Alarm Period
	Voice Message <i>High</i>
	<i>Low</i>
	<i>Off</i>
	Base unit alarm <i>On</i>
	<i>Off</i>

Device Setup	Smoke & Flood <i>Standard</i>
	<i>Always on</i>
	PIR Home Mode <i>On</i>
	<i>Off</i>
	Remote Key
	Wifi Reset
	Wifi On/Off <i>On</i>
	<i>Off</i>
Display&Tone	Key Tone <i>High</i>
	<i>Low</i>
	<i>Off</i>
	Contrast
	Language

The menu structure shows the language **English**. If you want to set another language, follow the operating sequence in the menu structure.

More detailed information on operating and navigating in the base unit is provided in Section **Setting Up the Base Unit on Page 20**.



Putting the Base Unit into Operation

This section explains how to position the alarm system or mount it on a wall optimally, insert the batteries and SIM card and supply power to the alarm system.

Positioning the Base Unit

Set the base unit down on a level, non-slip surface.

 To ensure even more operating convenience, we recommend that you install the legs supplied to the underside of the base unit. The base unit legs latch in place audibly.

Position the base unit of the alarm system

- Do not place the base unit on or in the direct vicinity of large metallic objects or electrical sources of interference which could impair the wireless communication.
- Position the base unit as centrally as possible in the area to be monitored to ensure optimum radio transmission of all components.
- You can install the base unit on a wall. To do this, screw two screws in the wall, 100 mm apart and horizontally aligned, and hook the heads of the screws in the recesses on the rear of base unit.

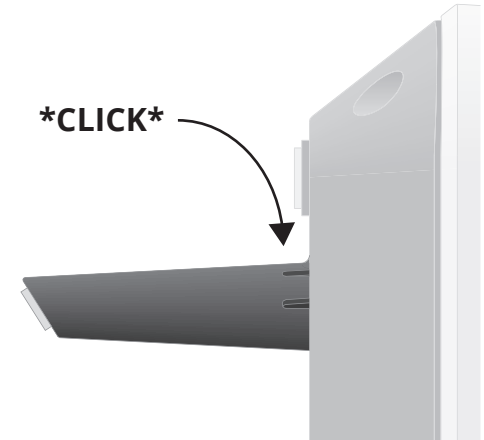





Inserting the SIM Card (Option)

 If you do not want to use a SIM card, simply skip this section.

If you want to be notified on your mobile phone in the event of an alarm being triggered, you need a commercially available SIM card. Insert the SIM card in the base unit as described below.

- 1 Slide the SIM card holder to the side to unlock the holder.
- 2 Pivot the holder up and insert the SIM card in the holder.
The metallic contacts of the SIM card must face down.
- 3 Pivot the holder downwards and slide the holder to the side to lock it.

 Please note that contractually linked costs may ensue when the telephone unit establishes connections to saved numbers via the SIM card.

 If you use an external antenna, set the switch on the antenna to **Ext.**

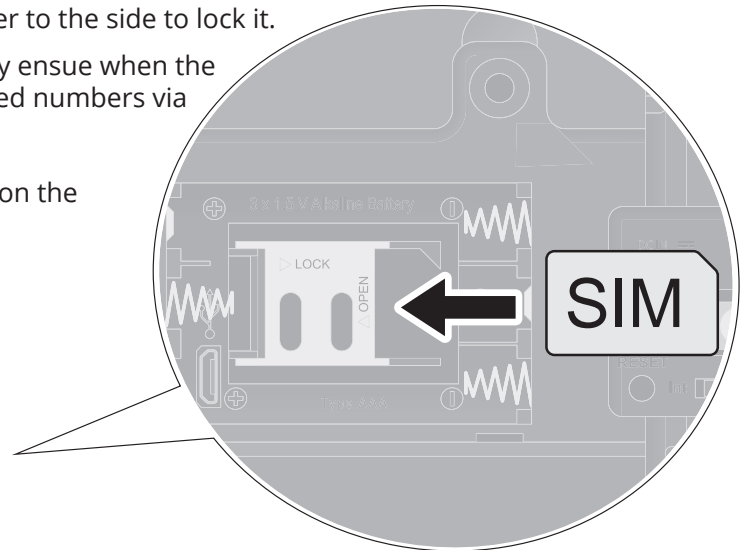
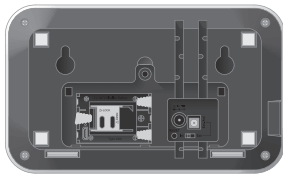



Inserting the Batteries (Option)

The use of batteries serves as a safeguard against power failure. In the case of normal power supply using the power adapter, the batteries are not affected. In the event of a power failure, power is supplied to the base unit by the batteries until the power supply returns or the batteries are empty.



ATTENTION! Risk of property damage through the use of inappropriate batteries! The use of inappropriate batteries can cause a loss of function of the device. Only use the batteries supplied or those of the type described in Section "Technical Data".

- 1 Loosen the screw in the battery compartment cover using an appropriate screwdriver.
- 2 Remove the battery compartment cover.
- 3 Insert three appropriate batteries in the battery compartment. Pay attention that the batteries are inserted the right way around.
- 4 Replace the battery compartment cover and tighten the screw in the battery compartment cover tight.

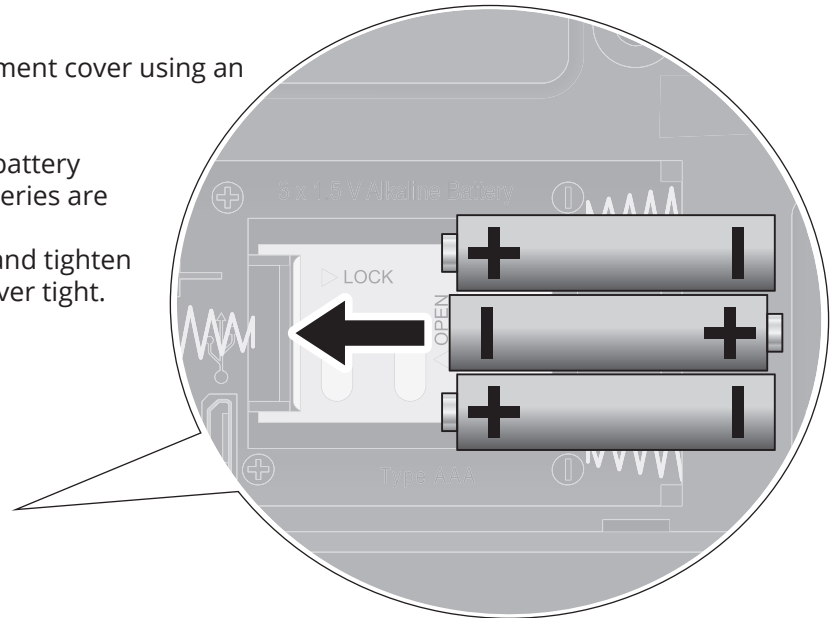
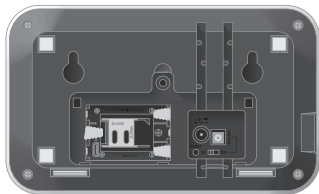





Connecting the Power Adapter

Power is supplied to the base unit of the alarm system via the power adapter. To ensure an uninterrupted power supply, you can insert the optionally available batteries into the base unit (see Section **Inserting the Batteries (Option)** on Page 18).

- 1 Loosen the screw in the battery compartment cover using an appropriate screwdriver.
- 2 Remove the battery compartment cover.
- 3 Plug the power adapter in the connection socket for the power adapter on the underside of the base unit.
- 4 Replace the battery compartment cover and tighten the screw in the battery compartment cover tight.
- 5 Plug the power adapter in a properly installed power socket.

 If you want to insert a SIM card or batteries in the base unit, follow the instructions under Inserting the SIM Card (Option) and Inserting the Batteries (Option) before you close the battery compartment.

 Use the cable duct to lay the power cable on the underside of the base unit.

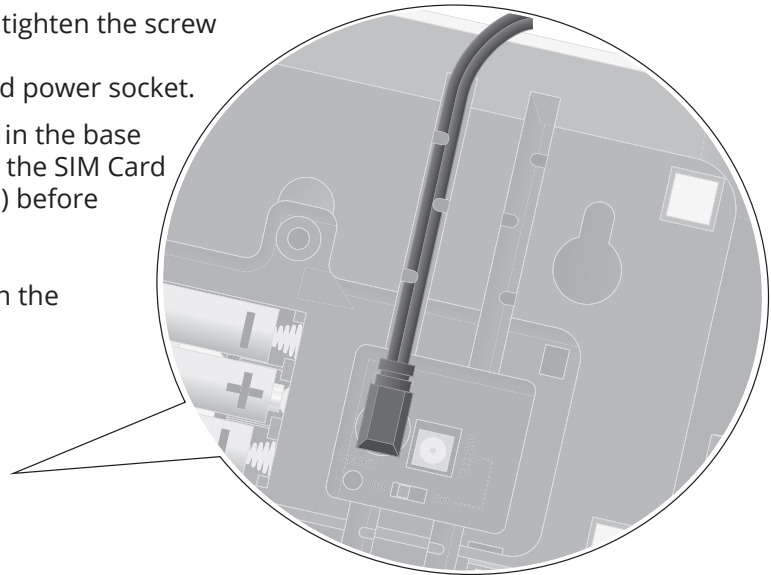
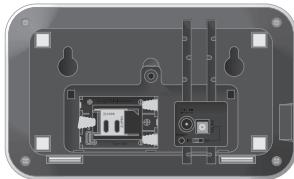



Setting Up the Base Unit

This section explains how to adapt the base unit of the alarm system to your own personal needs.

Also observe the information in the operating manual with regard to the individual sensors which you want to connect to the base unit of the alarm system.

Setting the Key Lock

Before beginning to operate the base unit, deactivate the key lock function.



The SOS and Panic keys are excluded from the key lock function and are always functional!

Entry Code

The base unit is protected by means of a four-digit entry code in order to prevent access to the base unit by unauthorised third parties.

The predefined entry code is active when the factory settings are set. The predefined entry code is provided in the battery compartment of the base unit and on the rear side of this operating manual.



For reasons of security, we recommend that you change the predefined entry code by your own personal entry code.

- 1 Select the **Entry Code** menu option.
- 2 Confirm by pressing **OK**. The predefined entry code appears in the display. The first digit flashes.
- 3 Enter your own personal, 4-digit entry code.



- 4 Confirm by pressing **OK**.
- 5 Note down your new entry code and keep it where it cannot be accessed by third parties.

Deactivating the Key Lock

- 1 Enter your personal entry code.
- 2 Confirm by pressing **OK**.

 When using the remote control, deactivate the key lock by pressing the  key.

Setting the Automatic Key Lock

You can define a period of time after which the key lock is automatically activated.

You can set a delay of between 20 and 40 seconds.

- 1 Select the **KeyLock Delay** menu option.
- 2 Confirm by pressing **OK**.
- 3 Set the required delay time.
- 4 Confirm by pressing **OK**.

Setting the Language

There is a range of languages available for selection:

- 1 Select the **Display&Tone** menu option.
- 2 Confirm by pressing **OK**.
- 3 Select the **Language** menu option.
- 4 Confirm by pressing **OK**.
- 5 Select the required language. Confirm by pressing **OK**.

Setting the Time and Date



The standard display which appears on the base unit shows the date and time. Therefore, set the current date and time.

- 1 Select the **Date/Time** menu option.
- 2 Confirm by pressing **OK**.
01-01-2017 appears in the display.
- 3 Enter the day, month and year. Confirm by pressing **OK**. **00:00** appears in the display.
- 4 Enter the time as hour and minute. Confirm by pressing **OK**.





Registering Sensors

You can register up to 64 sensors on the alarm system base unit.

- 1 Select the **Register** menu option.
 - 2 Confirm by pressing . The display shows **Search...**
 - 3 Trigger the sensor to be registered.
-  To find out how to trigger the individual sensors, see the Operating Manual under **Accessories - Sensors for the ProHome Series**. This manual is enclosed with the base unit.
- 4 The display shows the names of the active sensors, e.g. **Remote Key**.
 - 5 Confirm by pressing . The display shows **Voice Record**. You can either use the standard message or record an individual voice message.

In the following descriptions, you can use either an individually recorded voice message or standard message for the registered sensor. The individually recorded voice messages can be recorded or modified at a later point in time.

When the corresponding sensor is triggered, the related voice message is played over the loudspeaker of the base unit.



- 6 Press  if you want to retain the standard message of the registered sensor.
- 7 Press  to record an individual voice message.

 Further information is available in Section **Individual Voice Message on Page 23**.







Deregistering Sensors

If a sensor is no longer required, you can deregister that sensor from the base unit.

- 1 Select the **Review** menu option.
- 2 Select the sensor you wish to deregister.
- 3 Press the  key. The display shows **Delete?**.
- 4 Confirm by pressing .

Renaming Sensors





You can rename any of the registered sensors in order to adapt it to your own individual needs.

- 1 Select the **Review** menu option.
- 2 Confirm by pressing .
- 3 Select the required sensor.
- 4 Confirm by pressing .
- 5 Press the  key to delete the sensor name.
- 6 Enter a name for the sensor.
- 7 Confirm by pressing .
- 8 Press the .

Individual Voice Message

An individual outgoing voice message can be recorded for each sensor (door/window contact, smoke detector, etc.). Keep the message short (< 4 sec.).

The standard message is replaced by your individual voice message and played when the telephone unit is activated.

- 1 Select the **Review** menu option.
- 2 Confirm by pressing .
- 3 Select the required sensor.
- 4 Confirm by pressing .
- 5 The cursor flashes at the end of the sensor name. You can rename the sensor (see Section **Renaming Sensors on Page 23**).
- 6 Confirm by pressing .
- 7 The display shows **Voice Record**. Confirm by pressing .
- 8 Speak your message for the selected sensor. Keep the message short (< 4 sec.).
- 9 Confirm by pressing  to end the recording process. Your individual voice message is played back.



If you no longer like the voice message recorded, you can repeat the process.



Configuring the Telephone Unit

The telephone unit establishes a connection between the base unit and alarm system and the mobile communication network via an appropriate SIM card.



The SIM card is not included in the package contents.

Please note that contractually linked costs may ensue when the telephone unit establishes connections to saved numbers via the SIM card.

In the event of an alarm, the telephone unit automatically dials the alarm phone numbers stored (starting with storage location

The telephone unit is deactivated when

- the called person takes the call and presses the digit key [1] on their phone or
- the cycle of calls is completed 3 times.

Unlocking the SIM Card

As a rule, SIM cards are secured with a 4-digit PIN. When the SIM card is used for the first time, it must be unlocked.

- 1 If the SIM card is locked by a PIN, the **SIM PIN?** message appears in the display.
- 2 Remove the key lock on the base unit.



To do this, use e.g. the remote control. Press the  key.

- 3 Enter the PIN which you received together with the SIM card. If you enter the correct PIN, the display shows **Search...** Then the PIN is permanently deactivated.
- 4 If you enter the wrong PIN, the display shows **Enter Again?** Enter the PIN again.



If you enter the wrong PIN three times, the display shows **SIM Locked**. In this case, contact your mobile phone provider to release the lock.



Checking the SIM Card

On 1 January, 1 April, 1 July and 1 October, the display shows **Check SIM \$**.

- 1 Select the **Check SIM \$** menu option.
- 2 Confirm by pressing **OK**. The display shows **SIM Service #**.
- 3 Enter the service number of the mobile phone provider.

 If you require more information, please contact your mobile service provider.

- 4 Confirm by pressing **OK**. The service number is dialled.
- 5 Follow the instructions from the mobile phone provider.
- 6 End the connection by pressing **OK**.

Saving Alarm Call Numbers

You can save up to 10 alarm call numbers in the storage locations **0** to **9WXYZ**. These phone numbers are called as soon as one of the registered sensors triggers an alarm on the base unit.

 Agree on procedures in the event of an alarm with these contact persons in advance.

Each phone number can be composed of up to 24 digits and the associated name up to 13 characters.

 Do not save any public emergency call numbers! Unjustified requests for police, fire and rescue services are liable for costs!

- 1 Press **▼** . The display shows **Memory Key**.
- 2 Select a storage location (keys **0** to **9WXYZ**). If you have not yet saved a phone number, the display shows the entry **Empty**.
- 3 Confirm by pressing **OK**.
- 4 Enter a name.
- 5 Confirm by pressing **OK**.
- 6 Enter the full phone number.
- 7 Confirm by pressing **OK**.







Saving an SOS (Emergency Call) Number

You can store an emergency call number which is dialled first of all after pressing the **SOS** key or  key on the remote control.

Following this, the other stored phone numbers are dialled in succession.



Do not save any public emergency call numbers! Unjustified requests for police, fire and rescue services are liable for costs!

- 1 Press . The display shows **Memory Key**.
- 2 Select the **SOS** key as the required storage location. If you have not yet saved a phone number, the display shows the entry **Empty**.
- 3 Confirm by pressing .
- 4 Enter a name.
- 5 Confirm by pressing .
- 6 Enter the full phone number.
- 7 Confirm by pressing .



Testing the Telephone Unit

After having entered phone numbers, ensure that they are correct in respect of the response in the event of an alarm. You can trigger a silent alarm to do this.

- 1 Press . Silent mode is activated.
 - 2 Trigger the silent alarm for any sensor. The display lights up yellow and indicates which sensor has been triggered.
 - 3 The telephone unit is activated.
- The subscriber called lifts the receiver and hears either the individual outgoing voice message or standard voice message. Further information is provided in Section **Individual Voice Message on Page 23**.
 - The subscriber called is also requested to press digit key [1] on their telephone. The screening function is activated and enables the subscriber to screen the room in which the base unit is located.
 - The voice message is repeated a total of three times. If the subscriber **does not** press digit key [1] on his phone, the connection is automatically ended and the next phone number dialled.



The telephone unit and alarm are switched off:





- after pressing the  key on the remote control,
- after entering your entry code on the base unit and confirming with  or
- when the person called ends the current connection.

 The base unit is then in Silent mode.

Setting the Trigger Delay

You can set the actual alarm to be triggered after a delay. This provides you with sufficient time to enter your apartment or house and disarm the alarm system. You can set a trigger delay between 0 and 240 seconds. You can also select whether an acoustic signal (countdown) should be issued from the base unit during this period or not.

 If one of the sensors is tripped, the base unit must be disarmed within the trigger delay period to ensure no alarm is triggered.

- 1 Select the **Alarm Setup** menu option.
- 2 Confirm by pressing .
- 3 Select the **Trigger Delay** menu option.
- 4 Confirm by pressing .
- 5 Set the delay time.
- 6 Confirm by pressing .
- 7 Select the **Trigger Tone** menu option.
- 8 Confirm by pressing .
- 9 Switch the trigger tone to **On** or **Off**.
- 10 Confirm by pressing .



Setting the Arming Delay

You can set the alarm system to be armed following a defined delay. This provides you with sufficient time to leave your apartment or house through the alarm-protected front door before the alarm system is actually armed.

You can set an arming delay between 0 and 240 seconds.

During the delay period, you will hear a signal tone issued at intervals of one second.

- 1 Select the **Alarm Setup** menu option.
- 2 Confirm by pressing .
- 3 Select the **Arming Delay** menu option.
- 4 Confirm by pressing .
- 5 Set the delay time.
- 6 Confirm by pressing .

Setting the Alarm Period

The base unit is equipped with its own siren. The duration of the warning signal can be selected between a minimum of 1 minute to a maximum of 10 minutes.

The standard setting for the alarm period is 1 minute.

 Observe any locally applicable regulations regarding limitation of alarm times from burglar alarms.

- 1 Select the **Alarm Setup** menu option.
- 2 Confirm by pressing .
- 3 Select the **Alarm Period** menu option.
- 4 Confirm by pressing .
- 5 Set the alarm period.
- 6 Confirm by pressing .

Switching the Warning Signal from the Base Unit On/Off

This function enables the warning signal from the base unit to be switched on and off.

 This setting is useful, for example, if you have installed an additional outdoor siren. If an alarm is triggered, the outdoor siren issues a loud warning



signal and alerts others to the situation. The base unit remains silent, making it more difficult for the intruder to find the base unit.

- 1 Select the **Alarm Setup** menu option.
- 2 Confirm by pressing .
- 3 Select the **Base alarm** menu option.
- 4 Confirm by pressing .
- 5 Set the base unit warning signal to **High, Low** or **Off**.
- 6 Confirm by pressing .

Setting the Key Tone

It is possible to switch the key tone feature for the base unit on and off.

- 1 Select the **Display&Tone** menu option.
- 2 Confirm by pressing .
- 3 Select the **Key Tone** menu option.
- 4 Confirm by pressing .
- 5 Set the key tone to setting **High, Low** or **Off**.
- 6 Confirm by pressing .

Setting the Volume of the Voice Output

You can adjust the volume level of the voice output on the base unit or switch it off.

- 1 Select the **Alarm Setup** menu option.
- 2 Confirm by pressing .
- 3 Select the **Voice Message** menu option.
- 4 Confirm by pressing .
- 5 Set the volume of the voice output to **High, Low** or **Off**.
- 6 Confirm by pressing .

Setting the Contrast

You can adjust the contrast of the display to one of 5 different settings.

- 1 Select the **Display&Tone** menu option.
- 2 Confirm by pressing .
- 3 Select the **Contrast** menu option.
- 4 Confirm by pressing .
- 5 Set the required contrast setting using the and keys.
- 6 Confirm by pressing .



Monitoring Functions

You can adapt the alarm system according to your own personal needs. The table below provides an overview of how the base unit of your alarm system reacts to each respective monitoring function when activated.

 Pay attention that, in general, the warning signal is issued by the base unit. If you have deactivated the warning signal on the base unit and there is **no** outdoor siren installed, the alarm system remains **silent** in every monitoring function!

 Before switching any functions on, inform all the other people living in the residence regarding the location and method of operation of the wireless alarm system.

Monitoring function	Alarm signal	Telephone unit (GSM)
Alarm Mode	Yes	Yes
At Home Mode	Yes	No
Silent Mode	No	Yes, with screening function
Disarmed Mode	No	No
Panic Alarm	Yes	No
Emergency call (SOS)	No	Yes, with screening function
PIR At Home mode	See Section PIR At Home mode on Page 34	
Smoke and Water Detectors	See Section Smoke and Water Detectors on Page 35	
SOS / Panic alarm (remote control)	See Section Function of the  Key on Page 35	







Alarm Mode

When Alarm mode is active and an alarm is triggered, an acoustic warning signal is issued and the telephone unit is activated.

You should activate Alarm mode when you leave your apartment or house. Before doing so, check that all the doors and windows provided with a door/window contact are closed.

You can switch the mode on and off either using the base unit or via the remote control.

- 1 Enter your entry code.
- 2 Confirm by pressing .
- 3 Press the .

 To activate Alarm mode via the remote control, press the  key.

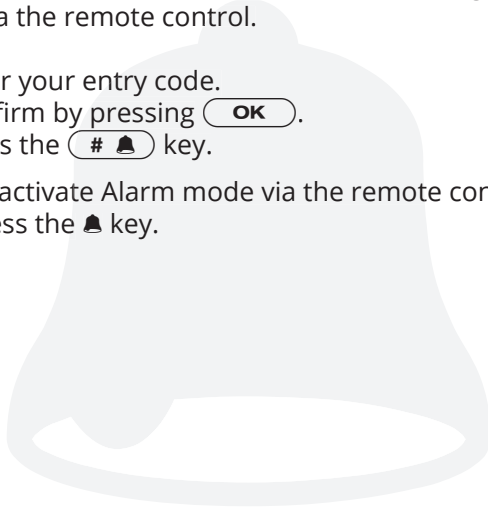





At Home Mode

When At Home mode is active and an alarm is triggered, only an acoustic alarm signal is issued.

It is recommended to activate At Home mode during the night. Before doing so, check that all the doors and windows are closed.

You can switch the mode on and off either using the base unit or via the remote control.

- 1 Enter your entry code.
- 2 Confirm by pressing .
- 3 Press the .

 To activate At Home mode via the remote control, press the  key.

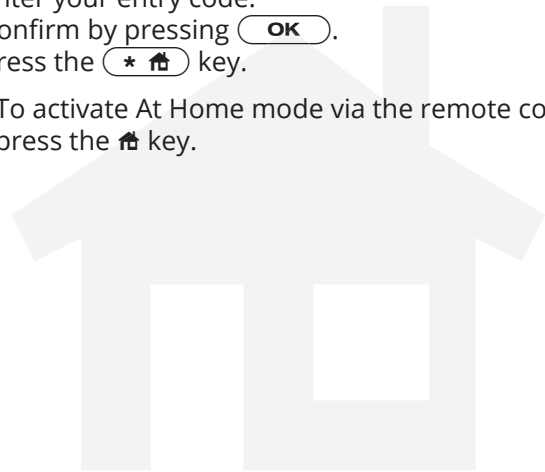







Silent Mode

When Silent mode is active, only the telephone unit is activated. A person called receives a voice message requesting them to press the [1] key on their phone. The screening function is activated.

When you leave your apartment or house, you can activate Silent mode instead of Alarm mode. Before doing so, check that all the doors and windows provided with a door/window contact are closed.

You can switch the mode on and off either using the base unit or via the remote control.

- 1 Enter your entry code.
- 2 Confirm by pressing **OK**.
- 3 Press the   key.

 To activate Silent mode via the remote control, press the  and  keys (simultaneously).



Disarmed Mode

When Disarmed mode is set, the alarm system is deactivated.

When the system is disarmed, you can move freely within the living quarters without triggering any alarms.

You can switch the mode on and off either using the base unit or via the remote control.

- 1 Enter your entry code.
- 2 Confirm by pressing **OK**.

 To activate Disarmed mode via the remote control, press the  key.

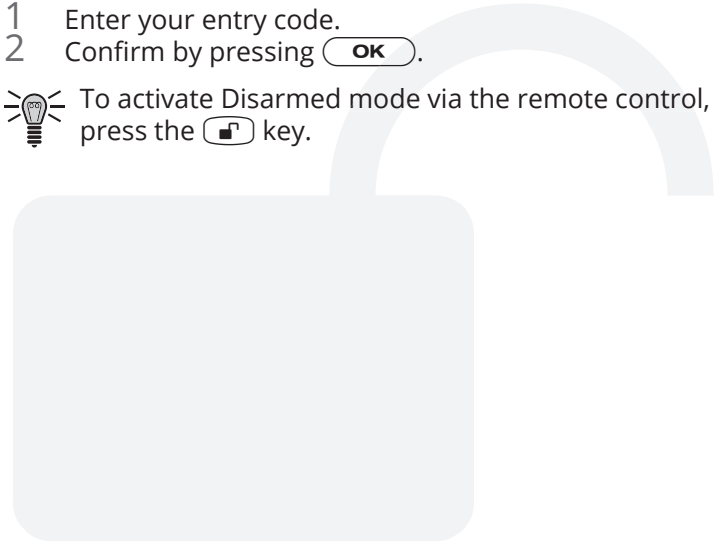



Panic Alarm

The Panic alarm serves as a deterrent and is triggered immediately.



Triggering the Panic Alarm



Caution! Hearing damage through loud alarm signal! The panic alarm is triggered immediately without any delay. Do not remain in the vicinity of the acoustic alarm for a longer period when it has been triggered.

- 1 Hold the  button for 3 seconds.



You can trigger the Panic alarm via the remote control (depending on the settings) by pressing the  key. Further information is provided in Section **Function of the  Key on Page 35.**

Stopping the Panic Alarm

- 1 Enter your own personal, 4-digit entry code on the base unit.
- 2 Confirm by pressing .



You can stop the Panic alarm via the remote control by pressing the  key.

Emergency call (SOS)

The emergency call (SOS) can be used in a threatening situation to send for help from previously stored numbers by pressing just one key.

Triggering an Emergency Call (SOS)

- 1 Hold the  button for 3 seconds.



You can trigger the emergency call (SOS) via the remote control (depending on the settings) by pressing the  key. Further information is provided in Section **Function of the  Key on Page 35.**

The telephone unit is activated if phone numbers are stored. The emergency call number (SOS) is dialled first, then up to 10 stored alarm phone numbers in succession.

A voice message requests the subscriber answering to press the [1] key on their phone.

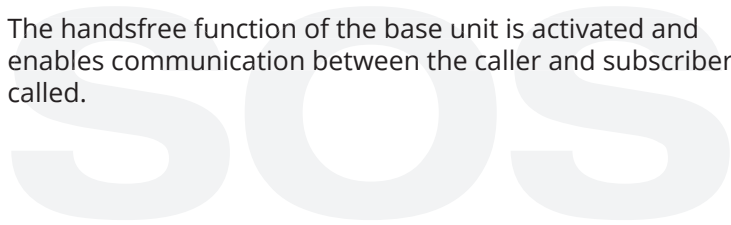

The handsfree function of the base unit is activated and enables communication between the caller and subscriber called.





Ending the Emergency Call (SOS)

There are three ways to end the emergency call (SOS) function:

- 1 Enter your entry code on the base unit and confirm it by pressing  or
- 2 press the  key on the remote control or
- 3 the subscriber called takes the call, executes a function within 24 seconds and then ends the call.



PIR At Home mode

The optional PIR At Home mode can be used to deactivate the alarm which is normally activated by the motion detectors in At Home mode.

When PIR At Home mode is activated, the motion detectors registered on the base unit in At Home mode are deactivated.



This means that false alarms caused by unavoidable movements within the area monitored (by residents, pets, etc.) can be prevented.

- 1 Select the **Device Setup** menu option.
- 2 Confirm by pressing .
- 3 Select the **PIR At Home Mode** menu option.
- 4 Confirm by pressing .
- 5 Switch the PIR At Home mode **On** or **Off**.
- 6 Confirm by pressing .



If you switch the PIR At Home mode **on**, the motion detectors are **deactivated**. If you switch the PIR At Home mode **off**, the motion detectors are **activated**.



Smoke and Water Detectors

You can set up the base unit so that water leak and smoke detectors also trigger an alarm when the base unit is disarmed or in Silent mode.

- 1 Select the **Device Setup** menu option.
- 2 Confirm by pressing .
- 3 Select the **Smoke & Flood** menu option.
- 4 Confirm by pressing .
- 5 Select the setting **Standard** or **Always on**.
- 6 Confirm by pressing .

The table below explains how the smoke and water detectors react.

	Standard		Always on	
	GSM	Alarm	GSM	Alarm
Silent Mode	Yes	No	Yes	Yes
Alarm Mode	Yes	Yes	Yes	Yes
At Home Mode	No	Yes	No	Yes
Disarmed Mode	No	No	Yes	Yes

Function of the Key

You can programme how the base unit responds after pressing the  key on the remote control.

Triggering the Panic Alarm

You can programme that a Panic alarm is triggered after pressing the  key on the remote control.

- 1 Select the **Device Setup** menu option.
- 2 Confirm by pressing .
- 3 Select the **Remote Key** menu option.
- 4 Confirm by pressing .
- 5 Select the setting **Panic**.
- 6 Confirm by pressing .

Triggering an Emergency Call (SOS)

You can programme that an emergency call (SOS) is triggered after pressing the  key on the remote control.

- 1 Select the **Device Setup** menu option.
- 2 Confirm by pressing .
- 3 Select the **Remote Key** menu option.
- 4 Confirm by pressing .
- 5 Select the **SOS** menu option.
- 6 Confirm by pressing .



Installing the ProHome App

You can configure and control the base unit and associated components with the ProHome app.



The ProHome App works under iOS from version 8 (iPhone 5S / iPad Air / iPad Mini 2 or newer) and Android from version 5.0.

- 1 Download the ProHome app from the app store or Google Play Store.
- 2 Enable access by the **ProHome app** to the camera of your smartphone or tablet and mobile internet.



You require access to your smartphone or tablet camera to scan the QR code.



You can also enable or disable access to the camera and mobile internet later using the settings of your smartphone or tablet. For further information, see the operating manual of your smartphone or tablet.



Setting up the Base Unit with the ProHome app



The following describes how to set up the base unit using the ProHome app for iOS.

All the steps are identical for Android.

Before you can set up the base unit with the ProHome app, the following conditions must be met:

- You have connected up the base unit.
- You have installed the **ProHome app** on your smartphone or tablet.
- You have connected your smartphone or tablet with your network.



You must connect your base unit with your network:

- 1 Start up the ProHome app on your smartphone or tablet.
- 2 Read the instructions carefully and tap on **Continue** until your device's camera is activated.
- 3 Use your smartphone or tablet to scan the QR code on the rear of the base unit.

 If you can not scan the QR code, tap on **Manual input of the UID** and manually enter the following data from the rear of the base unit:

- UID
- Password
- SSID

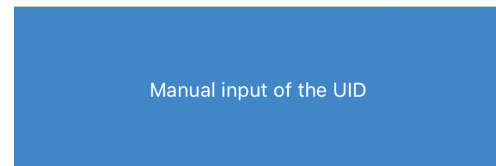



INSTALLING THE PROHOME APP

- 4 After you have successfully scanned the QR code, the base unit is shown (with a clear UID).
- 5 Tap on **First setup routine**.



If you want to add an additional smartphone or tablet to an existing **Gateway**, tap on **Additional device** and follow the instructions.

< Add Device

Required information on the device has been read successfully.

UID 5224ANNGEDSG9XPX111A

Please select if this is the first registration process.

First setup routine

Add your device to an existing ProHome gateway.

Additional device



 In this step, you must connect your smartphone or tablet to the base unit WiFi. The SSID of the base unit WiFi is shown.

- 6 Change to the WiFi settings of your smartphone or tablet and connect the device to the base unit WiFi (OLYMPIA-XXXX).
- 7 Change back to the ProHome app and tap on **Continue**.

 Your device now searches for available WiFi. This can take a moment. The available WiFi are listed.

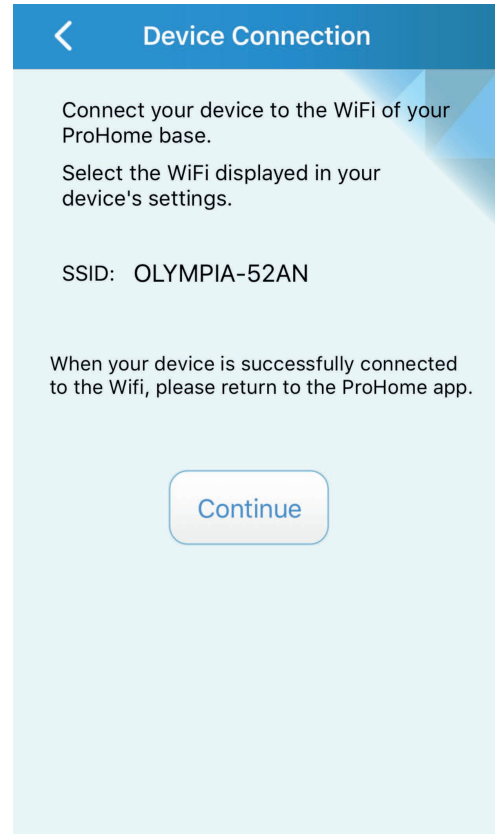



INSTALLING THE PROHOME APP

- 8 Select your personal WiFi and enter the WiFi password. Tap on **Continue**.
- 9 Enter a new password for the base unit. Tap on **Confirm**.

 The password must have at least 8 letters and numbers. Special characters are not permitted.

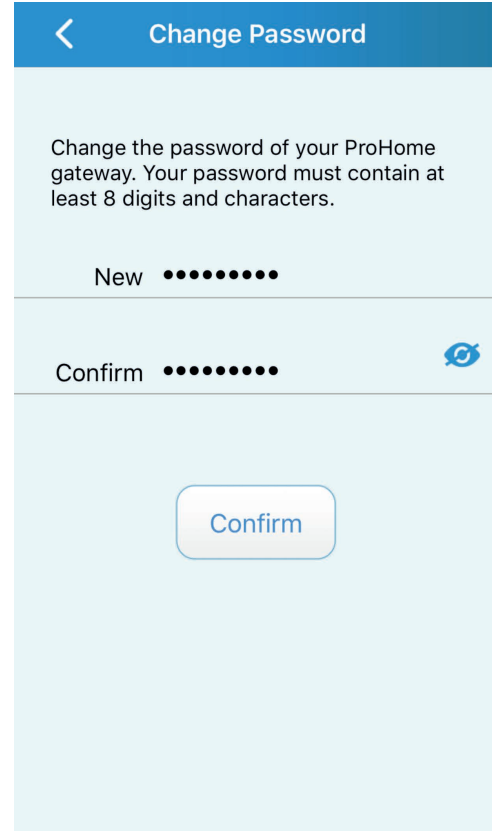

< Change Password

Change the password of your ProHome gateway. Your password must contain at least 8 digits and characters.

New ●●●●●●●●

Confirm ●●●●●●●● 

Confirm



- 10 The connection with the base unit is established. This process takes 30 seconds. When the connection is successful, the blue LED on the base unit lights up steadily. Tap on **Yes**.

If the LED on the base unit does not light up steadily after 30 seconds, tap on **No** and repeat the setup of the base unit.

- 11 The base unit is successfully connected to the ProHome app. Tap on **Continue**.

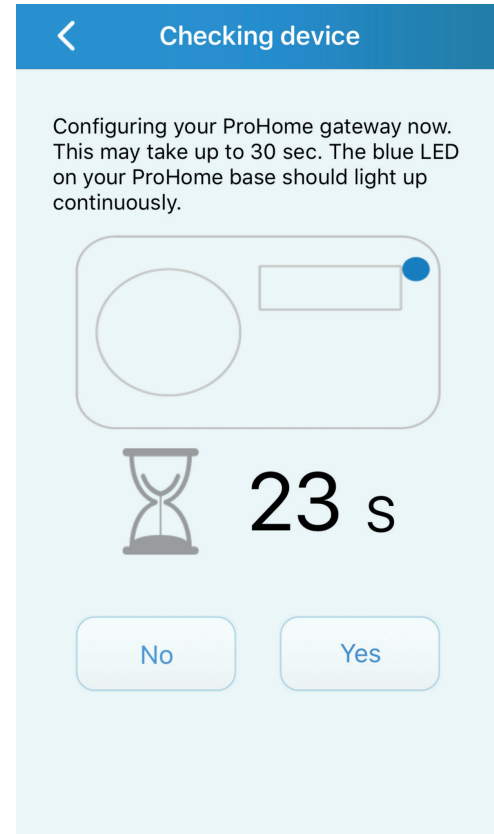



INSTALLING THE PROHOME APP

The setup is complete. Now the base unit shows up in the list of available devices as a **Gateway**.

You can find further information about controlling the base unit with the ProHome app on our website at www.olympia-prohome.de

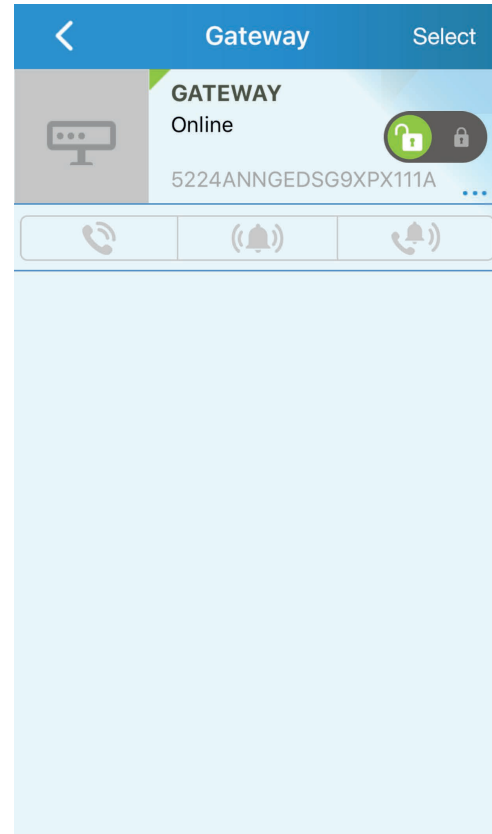



Remote Access by Phone

The wireless alarm system can be operated by remote access using a telephone.

- 1 Dial the phone number of the SIM card installed in the base unit.
- 2 Wait until the base unit takes your call. A longer acoustic signal is issued.
- 3 Enter the 4-digit entry code on the base unit. You will hear two short acoustic tones.
- 4 Complete various functions using the phone's keypad (refer to the table). The monitoring functions are confirmed by a voice message.

Key	Function
1	Activate the handsfree function
2	Activate call screening
3	Activate Alarm mode
4	Activate At Home mode
5	Activate Silent mode
6	Activate Disarmed mode
#	Stop the Handsfree / Call screening function
#, #	End remote access

Appendix

Updating Firmware

Before you can update the firmware of your base unit, the following conditions must be met:

- You have connected up the base unit.
- You have installed the **ProHome app** on your smartphone or tablet.
- You have connected your smartphone or tablet with your network.
- You have added your base unit as a Gateway in the ProHome app.

- 1 Select the **FW Update** menu option on the base unit.
- 2 Confirm by pressing .
- 3 The display shows **Confirm?**.
- 4 Confirm by pressing .

The firmware on your base unit is updated; this can take a few minutes. After conclusion of the update, the display shows **Successful**.



Resetting WiFi Settings

If you want to integrate your base unit into another home network, you must first reset the WiFi settings of your base unit.

Other settings such as the base unit PIN or registered sensors are not deleted.

- 1 Select the **Device Setup** menu option.
- 2 Confirm by pressing .
- 3 Select the **Wifi Reset** menu option.
- 4 Confirm by pressing .

The **Wifi Reset** entry flashes on the display and after a few seconds you will hear an acoustic signal. This means the WiFi settings have been reset.

Now you can integrate your base unit in a different home network. Follow the instructions in the section **Setting up the Base Unit with the ProHome app on Page 36.**

Switching WiFi off/on

If you do not want to use the smart home functions of your alarm system, you can switch off the WiFi. This reduces the radio waves and energy consumption of the base unit.

- 1 Select the **Device Setup** menu option.
- 2 Confirm by pressing .
- 3 Select the **Wifi On/Off** menu option.
- 4 Confirm by pressing .
- 5 Switch the base unit WiFi function **On** or **Off**.
- 6 Confirm by pressing .



If you have switched the WiFi function of your alarm system off, you can not establish a connection to your home network or the ProHome app.



Restoring the Default Factory Settings

Please note that on restoring the factory settings, all the user settings will be deleted. The registration of the sensors is retained.



When you restore the factory settings of the base unit, you will find the valid PIN and password on the label on the rear of the base unit and this operating manual.

- 1 Loosen the screw in the battery compartment cover on the underside of the base unit using an appropriate screwdriver.
- 2 Remove any batteries which are already inserted.
- 3 Press the RESET key. The base unit confirms the factory settings have been restored by issuing an acoustic signal.
- 4 Insert three appropriate batteries in the battery compartment. Pay attention that the batteries are inserted the right way around.
- 5 Replace the battery compartment cover and tighten the screw in the battery compartment cover tight using an appropriate screwdriver.

Changing the Battery

If the battery charge of the sensors is low or almost fully discharged, the corresponding status message appears on the display (**BATT. LOW. / BATT. OFF**). Change the batteries as soon as possible in such cases to ensure a reliable connection of all the components integrated in the alarm system.

Find out how to replace the batteries in the individual sensors in the operating manual under **Accessories - Sensors for the ProHome Series**. This manual is enclosed with the base unit.

You can also find the operating manual, **Accessories - Sensors for the ProHome Serie** on our website at www.olympia-prohome.de



Technical Data - Base Unit

Weight	228 g (without batteries)
Dimensions (W x H x D)	172 x 105 x 31 [mm]
Frequency (radio)	868.5 MHz
Frequency (GSM)	800 / 900 / 1800 / 1900 MHz
Frequency (WiFi)	2.4 GHz
Maximum transmission power	Radio (868.5 MHz): 25 mW GSM: 3.2 W WiFi: 94 mW
Sensors	Up to 64
Battery (option)	3 x alkaline batteries (AAA, 1.5 V)
Power supply	Input: 230 V, 50/60 Hz, 200 mA Output: 5 V, 1200 mA
Permissible ambient conditions	-10 °C to +40 °C at 30% to 75% rel. humidity

Technical Data - Remote Control

Weight	Approx. 20 g
Dimensions (W x H x D)	40 x 60 x 14.5 mm
Frequency (radio)	868.5 MHz
Maximum transmission power	0.04 mW
Batteries	1 x round cell battery, CR2032
Permissible ambient conditions	-10 °C to +40 °C at 30% to 75% rel. humidity

System Extensions

You can order numerous extensions for your Olympia alarm system through our website.

Visit us at www.olympia-prohome.de



Cleaning and Service

- 1 Disconnect the base unit from the power supply before starting any cleaning work.
- 2 Clean the surface of the housing with a soft, lint-free cloth. Never use any chemicals or scouring agents.
- 3 Check the functionality of each sensor registered once a month and after changing the batteries.
- 4 Change the batteries at least once a year or after receiving the relevant message from the alarm system.

Information on Disposal



The adjacent symbol indicates that electrical and electronic apparatus and batteries no longer required must be disposed of separate from domestic waste in accordance with legal directives. You are legally obliged to dispose of batteries and power packs at shops which sell batteries or collection points which provide the corresponding containers. Disposal is free of charge. The symbols indicate that the batteries must not be disposed of in normal domestic waste and that they must be brought to collection points provided by local public waste authorities. Packaging materials must be disposed of according to local regulations.

Guarantee

Dear Customer,

we are pleased that you have chosen this equipment.

In the case of a defect, please return the device together with the receipt and original packing material to the point-of-sale.

Information on Conformity

 Olympia Business Systems Vertriebs GmbH, Zum Kraftwerk 1, 45527 Hattingen hereby declares that this device fulfils the basic requirements and other relevant provisions stipulated in the Directive 2014/53/EC.



The CE Mark on the device confirms conformity.

You can find the conformity declaration for this product at <http://productip.com/?f=69ce5>



This is the individual information about the base unit.

If you want to change this predefined entry code, please refer to Chapter "Setting up the Base Unit" in this operating manual. Keep this operating manual in a safe place away from the alarm system!

Subject to change without prior notice.

www.olympia-prohome.de

OLYMPIA

v1.0, 11.2017 Art. No. 6005
ProHome Series Base Unit