

USER MANUAL

G-MASTER

LCD Monitor

ENGLISH

G-MASTER GB2870UHSU

Thank you very much for choosing the iiyama LCD monitor.

We recommend that you take a few minutes to read this comprehensive manual carefully before installing and switching on the monitor. Please keep this manual in a safe place for your future reference.



Dear user, we congratulate you on the purchase of your iiyama LCD.

For details on warranty and locally used pixel policies that apply directly after installation of your product please check the iiyama website.

To report a fault, please contact your local support centre found at www.iiyama.com/service

Things to check before you call the iiyama information line

- | if the power cable is connected securely and turned on?
- | if the display has been turned on?
- | if the signal cable is connected securely and the correct input selected?
- | if the computer has been restarted with the display connected?
- | if the graphics card is correctly installed with the latest drivers possible?
- | if the correct native resolution has been selected via 'Display Properties'?
- | If the R/G/B signal configuration is correct?
- | if the displays On Screen Menu is shown?
- | if the correct brightness and contrast settings have been set?
- | if given display tolerances and compatibility have been considered?
- | if via the On Screen Menu you have performed a Factory Reset/Recall?

Before reporting the screen defect, please prepare the following information/evidence:

- | model number *
- | purchase receipt and serial number *
- | name and address for collection
- | telephone/fax number, for availability during the day
- | convenient collection date (date, time)
- | short description of the defect

Important Note:

If there is no fault found in the collected equipment after inspection, the transferring party shall incur charges for transport and administration.

If you have checked all of the above and there is still no picture, call our information line for assistance in your country.

* see the identification plate on the back of the case.

CE MARKING DECLARATION OF CONFORMITY

This LCD monitor complies with the requirements of the EC/EU Directive 2014/30/EU "EMC Directive", 2014/35/EU "Low Voltage Directive", 2009/125/EC "ErP Directive" and 2011/65/EU "RoHS Directive".

The electro-magnetic susceptibility has been chosen at a level that gives correct operation in residential areas, business and light industrial premises and small-scale enterprises, inside as well as outside of the buildings. All places of operation are characterised by their connection to the public low voltage power supply system.

IYAMA CORPORATION: Wijkmeerstraat 8, 2131 HA Hoofddorp, The Netherlands

Model No. : PL2870UH



We recommend recycling of used product. Please contact your dealer or iiyama service center. Recycle information is obtained via the Internet, using the address: <http://www.iiyama.com>

You can access the Web page of different countries from there.

- We reserve the right to change specifications without notice.
- All trademarks used in this user manual are the property of their respective owners.
- Eprel registration number G-MASTER GB2870UHSU-B1 : 1059398

TABLE OF CONTENTS

| | |
|---|----|
| FOR YOUR SAFETY..... | 1 |
| SAFETY PRECAUTIONS..... | 1 |
| SPECIAL NOTES ON LCD MONITORS..... | 3 |
| CUSTOMER SERVICE..... | 3 |
| CLEANING..... | 3 |
| BEFORE YOU OPERATE THE MONITOR..... | 4 |
| FEATURES..... | 4 |
| CHECKING THE CONTENTS OF THE PACKAGE..... | 4 |
| INSTALLATION..... | 5 |
| FITTING AND REMOVAL OF BASE..... | 7 |
| CONTROLS AND CONNECTORS..... | 8 |
| CONNECTING YOUR MONITOR..... | 9 |
| COMPUTER SETTING..... | 10 |
| ADJUSTING THE HEIGHT AND THE VIEWING ANGLE..... | 10 |
| OPERATING THE MONITOR..... | 11 |
| ADJUSTMENT MENU CONTENTS..... | 12 |
| STANDBY FEATURE..... | 24 |
| TROUBLE SHOOTING..... | 25 |
| RECYCLING INFORMATION..... | 26 |
| APPENDIX..... | 27 |
| SPECIFICATIONS..... | 27 |
| DIMENSIONS..... | 28 |
| COMPLIANT TIMING..... | 29 |

FOR YOUR SAFETY

SAFETY PRECAUTIONS

WARNING

STOP OPERATING THE MONITOR WHEN YOU SENSE TROUBLE

If you notice any abnormal phenomena such as smoke, strange sounds or fumes, unplug the monitor and contact your dealer or iiyama service center immediately. Further use may be dangerous and can cause fire or electric shock.

NEVER REMOVE THE CABINET

High voltage circuits are inside the monitor. Removing the cabinet may expose you to the danger of fire or electric shock.

DO NOT PUT ANY OBJECT INTO THE MONITOR

Do not put any solid objects or liquids such as water into the monitor. In case of an accident, unplug your monitor immediately and contact your dealer or iiyama service center. Using the monitor with any object inside may cause fire, electric shock or damage.

INSTALL THE MONITOR ON A FLAT, STABLE SURFACE

The monitor may cause an injury if it falls or is dropped.

DO NOT USE THE MONITOR NEAR WATER

Do not use where water may be splashed or spilt onto the monitor as it may cause fire or electric shock.

OPERATE UNDER THE SPECIFIED POWER SUPPLY

Be sure to operate the monitor only with the specified power supply. Use of an incorrect voltage will cause malfunction and may cause fire or electric shock.

PROTECT THE CABLES

Do not pull or bend the power cable and signal cable. Do not place the monitor or any other heavy objects on the cables. If damaged, the cables may cause fire or electric shock.

ADVERSE WEATHER CONDITIONS

It is advisable not to operate the monitor during a heavy thunder storm as the continual breaks in power may cause malfunction. It is also advised not to touch the plug in these circumstances as it may cause electric shock.

CAUTION

INSTALLATION LOCATION

Do not install the monitor where sudden temperature changes may occur, or in humid, dusty or smoky areas as it may cause fire, electric shock or damage. You should also avoid areas where the sun shines directly on the monitor.

DO NOT PLACE THE MONITOR IN A HAZARDOUS POSITION

The monitor may topple and cause injury if not suitably located. Please also ensure that you do not place any heavy objects on the monitor, and that all cables are routed such that children may not pull the cables and possibly cause injury.

MAINTAIN GOOD VENTILATION

Ventilation slots are provided to keep the monitor from overheating. Covering the slots may cause fire. To allow adequate air circulation, place the monitor at least 10cm (or 4 inches) from any walls. When removing the tilt stand, the ventilation slots on the back side of the monitor can be blocked. This may overheat the monitor and may cause fire or damage. Make sure to allow enough ventilation when removing the tilt stand. Operating the monitor on its back, side, upside down or on a carpet or any other soft material may also cause damage.

DISCONNECT THE CABLES WHEN YOU MOVE THE MONITOR

When you move the monitor, turn off the power switch, unplug the monitor and be sure the signal cable is disconnected. If you do not disconnect them, it may cause fire or electric shock.

UNPLUG THE MONITOR

If the monitor is not in use for a long period of time it is recommended that it is left unplugged to avoid accidents.

HOLD THE PLUG WHEN DISCONNECTING

To disconnect the power cable or signal cable, always pull it by the plug. Never pull on the cable itself as this may cause fire or electric shock.

DO NOT TOUCH THE PLUG WITH WET HANDS

Pulling or inserting the plug with wet hands may cause electric shock.

WHEN YOU INSTALL THE MONITOR ON YOUR COMPUTER

Be sure the computer is strong enough to hold the weight of the monitor, otherwise, you may damage your computer.

CAREFUL! PROTECT YOUR HANDS AND FINGERS

- Be careful not to hurt your fingers or hands when you change the height or the angle.
- Injury can occur if care is not taken to avoid finger contact with the displays base when adjusting the height. (Just for height adjustable model.)

REMARK FOR 24/7 USAGE

This product is not specifically designed for 24/7 usage in all environments.

REMARK FOR WALL MOUNTING

This product is not designed for digital signage (electronic signboard) applications such as wall mounting.

OTHERS

ERGONOMIC RECOMMENDATIONS

To eliminate eye fatigue, do not operate the monitor against a bright background or in a dark room. For optimal viewing comfort, the monitor should be just below eye level and 40-60 cm (16-24 inches) away from your eyes. When using the monitor over a prolonged time, a ten minute break every hour is recommended as looking at the screen continuously can cause eye strain.

SPECIAL NOTES ON LCD MONITORS

The following symptoms are normal with LCD monitors and do not indicate a problem.

NOTE

- When you first turn on the LCD monitor, the picture may not fit in the display area because of the type of computer that is used. In this case, adjust the picture position to the correct position.
- You may find slightly uneven brightness on the screen depending on the desktop pattern you use.
- Due to the nature of the LCD screen, an afterimage of the previous screen may remain after switching the image, when the same image is displayed for hours. In this case, the screen can be recovered slowly by changing the image or turning off the Power Switch for some hours.

CUSTOMER SERVICE

NOTE

- If you have to return your unit for service and the original packaging has been discarded, please contact your dealer or iiyama service center for advice or replacement packaging.

CLEANING

WARNING

- If you drop any materials or liquids such as water into the monitor when cleaning, unplug the power cable immediately and contact your dealer or iiyama service center.

CAUTION

- For safety reasons, turn off the power switch and unplug the monitor before you clean it.

NOTE

- To protect the LCD panel, do not scratch or rub the screen with a hard object.
- Never use any of the following strong solvents. These will damage the cabinet and the LCD screen.

| | |
|------------------|--------------------------|
| Thinner | Spray-type cleaner |
| Benzine | Wax |
| Abrasive cleaner | Acid or Alkaline solvent |

- Touching the cabinet with any product made from rubber or plastic for a long time may cause degeneration or loss of paint on the cabinet.

CABINET

Stains can be removed with a cloth lightly moistened with a mild detergent solvent. Then wipe the cabinet with a soft dry cloth.

LCD SCREEN

Periodic cleaning with a soft dry cloth is recommended.

Don't use tissue paper etc. because these will damage the LCD screen.

BEFORE YOU OPERATE THE MONITOR

FEATURES

- ◆ Supports Resolutions up to 3840 × 2160
- ◆ High Contrast 1000:1 (Typical), Adv. Contrast Function Available / Brightness 300cd/m² (Typical), 400cd/m² (HDR peak)
- ◆ Supports AMD FreeSync™ Premium technology
- ◆ Flicker - Free
- ◆ Moving Picture Response Time 1ms
- ◆ Blue Light Reducer
- ◆ Digital Character Smoothing
- ◆ 2 × 2W Stereo Speakers
- ◆ Standby Feature
- ◆ VESA Mounting Standard (100mm×100mm) Compliant
- ◆ Keyhole for Security Lock

CHECKING THE CONTENTS OF THE PACKAGE

The following accessories are included in your package. Check to see if they are enclosed with the monitor. If anything is missing or damaged, please contact your local iiyama dealer or regional iiyama office.

- Power Cable*
- USB Cable
- Quick Start Guide
- HDMI Cable
- Stand-Base with a screw
- DisplayPort Cable
- Safety Guide

CAUTION

- * The rating of the Power Cable enclosed in 120V area is 10A/125V. If you are using a power supply higher than this rating, then a power cable with a rating of 10A/250V must be used. However, all guarantees and warranties are void for any problems or damage caused by a power cable not supplied by iiyama. An approved power cable greater or equal to H05VVVF, 3G, 0.75mm² must be used.

INSTALLATION

CAUTION

- Before installation, make sure the display arm or desk arm stand is strong enough to hold the necessary weight of the display and the mount.
- Angle adjustment range :
18 degrees upward and 3 degrees downward

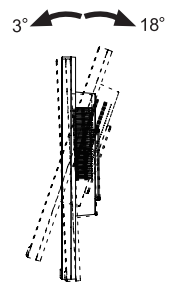

< DISPLAY ARM OR DESK ARM STAND >

CAUTION

When you use with the display arm or desk arm stand, in consideration of thickness of the mounting stage, tighten the M4 Screws (4pcs) which "L" length is 7mm to fasten the monitor. Using the screw longer than this may cause electric shock or damage because it may contact with the electrical parts inside the monitor.

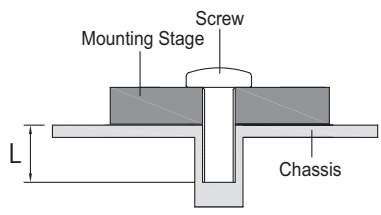

< ROTATING THE DISPLAY >

The monitor is designed to be compatible with both landscape and portrait modes. Video card for portrait display will be required for rotating the image on the screen.

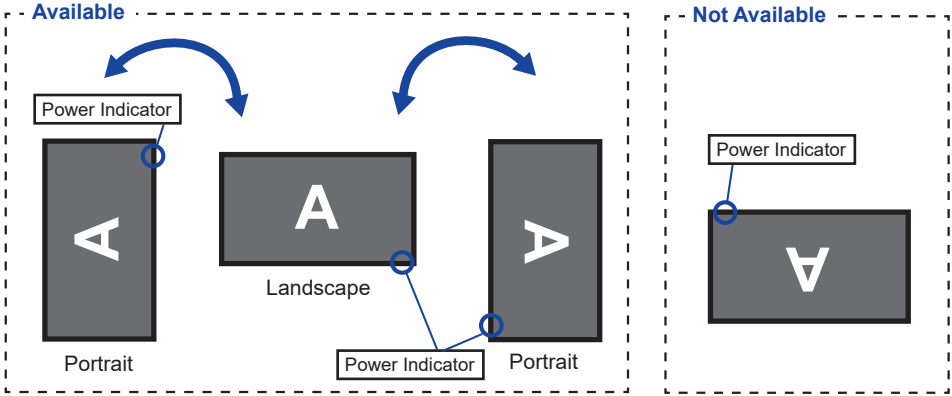

With Stand:

NOTE

- Adjust the monitor's height before panel rotation.
- Attempting to rotate the panel forcibly without adjusting the stand height may cause damage to the panel or the stand.

FITTING AND REMOVAL OF BASE

CAUTION

- Put the monitor on a stable surface. The monitor may cause injury or damage if it falls or is dropped.
- Do not give a strong impact to the monitor. It may cause damage.
- Unplug the monitor before removal or installation to avoid an electric shock or a damage.

<Installation>

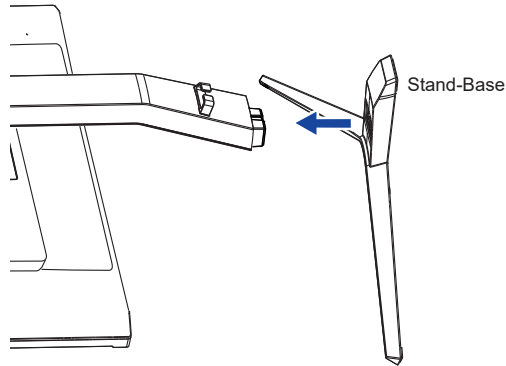

- ① Put a piece of soft cloth on the table beforehand to prevent the monitor from being scratched. Lay the monitor flat on a table with front face down.
- ② Install the Stand-Base as shown on the above picture.
- ③ Tighten the 'thumb screw' to secure the Stand-Base to the monitor.

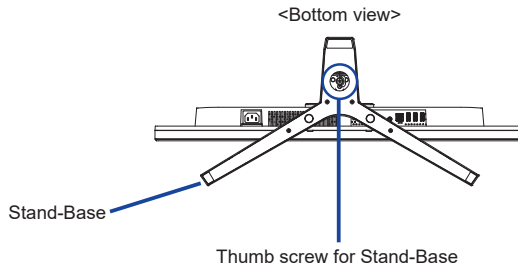

<Removal>

- ① Put a piece of soft cloth on the table beforehand to prevent the monitor from being scratched. Lay the monitor flat on a table with front face down.
- ② Loosen the 'thumb screw' to remove the Stand-Base from the monitor.

CONTROLS AND CONNECTORS

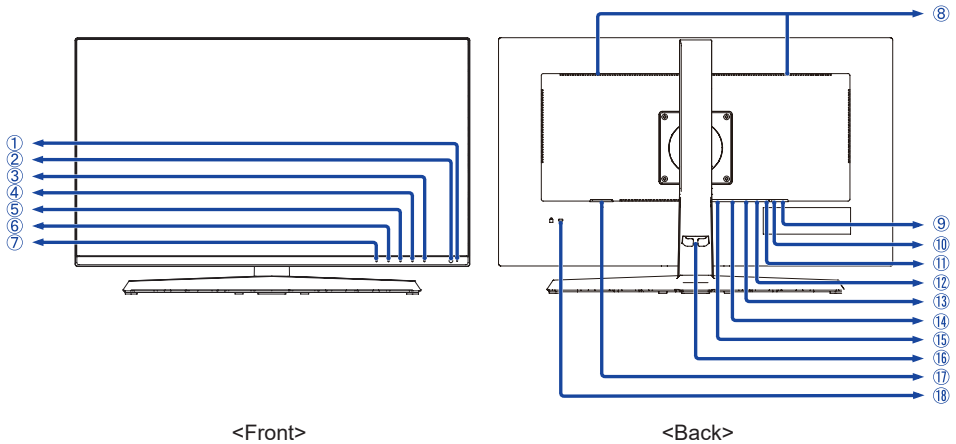

① Power Indicator

NOTE Blue: Normal operation
Orange: Standby mode

② Power Switch (⏻)

③ Menu Button (ENTER)

④ Scroll Up / Volume Button (▶ / 🔊)

⑤ Scroll Down / i-Style Color Button (◀ / i)

⑥ Exit / ECO Mode Button (EXIT / ⌂)

⑦ Input Select Button (INPUT)

⑧ Speakers

⑨ USB Downstream Connector (🔌 5V, 900mA)

⑩ USB Downstream Connector (🔌 5V, 900mA)

⑪ USB Downstream Connector (🔌 5V, 900mA)

⑫ USB Upstream Connector (🔌)

⑬ Headphone Connector (LINE OUT)

⑭ DisplayPort Connector (DP)

⑮ HDMI Connector (HDMI)

⑯ Cable Holder

⑰ AC Connector (~ : Alternating current) (~)

⑱ Keyhole for Security Lock

NOTE You can fasten a security lock and cable to prevent the monitor from being removed without your permission.

CONNECTING YOUR MONITOR

- ① Ensure that both the computer and the monitor are switched off.
- ② Connect the computer to the monitor with the signal cable.
- ③ Connect the computer to the monitor with the USB Cable.
- ④ Connect the Power Cable to the monitor first and then to the power source.
- ⑤ Turn on your monitor and computer.

NOTE

- Make sure that the building installation has a circuit breaker of 120/240V, 20A (maximum).
- The signal cables used for connecting the computer and monitor may vary with the type of computer used. An incorrect connection may cause serious damage to both the monitor and the computer. The cable supplied with the monitor is for a standard connector. If a special cable is required please contact your local iiyama dealer or regional iiyama office.
- Make sure you tighten the finger screws at each end of the signal cable.
- The Class I pluggable equipment Type A must be connected to protective earth.
- The socket-outlet shall be installed near the equipment and shall be easily accessible.
- Excessive sound pressure from ear/headphones can cause hearing damage/hearing loss.

[Example of Connection]

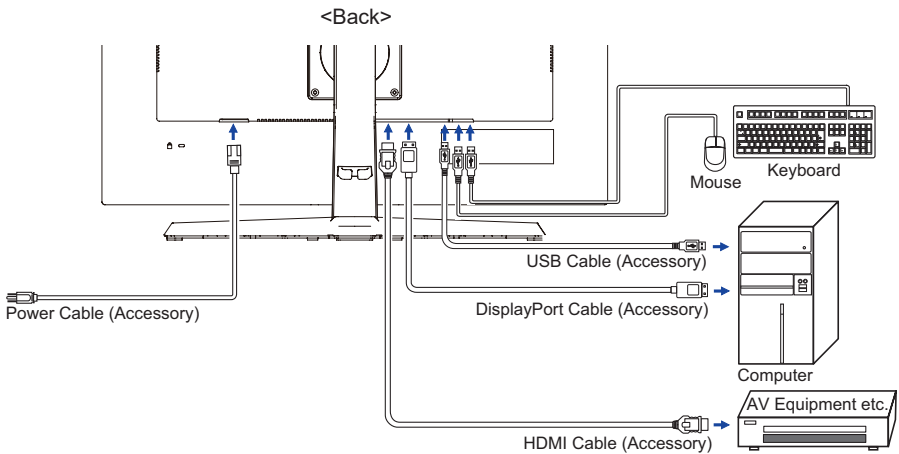

[Collect Cables]

Put the cables through the cable holder to bundle them.

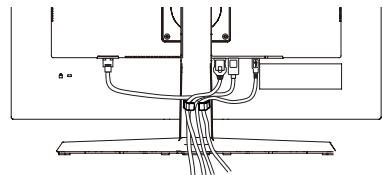

COMPUTER SETTING

■ Signal Timing

Change to the desired signal timing listed on page 29: COMPLIANT TIMING.

ADJUSTING THE HEIGHT AND THE VIEWING ANGLE

- For optimal viewing it is recommended to position yourself directly opposite to the full face of the monitor, then adjust the monitor's height and angle to your own preference.
- Hold the panel so that the monitor does not topple when you change the monitor's height or angle.
- You are able to adjust the monitor's height up to 130mm and left, 18° upward and 3° downward.

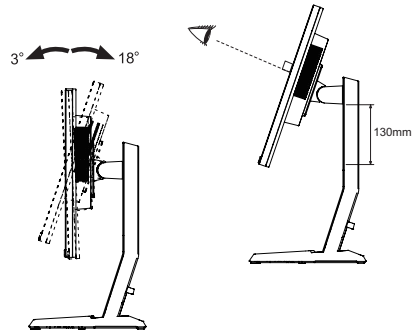

- NOTE**
- Do not touch the LCD screen when you change the height or the angle. It may cause damage or break the LCD screen.
 - Careful attention is required not to pinch your fingers or hands into the moving part of the stand when you change the height or the angle.
 - Injury can occur if care is not taken to avoid finger contact with the displays base when adjusting the height.

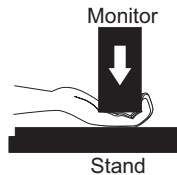

OPERATING THE MONITOR

To create the best picture, your iiyama LCD monitor has been preset at the factory with the COMPLIANT TIMING shown on page 29. You are also able to adjust the picture by following the button operation shown below.

- 1 Press the ENTER Button to start the On Screen Display feature.



- 2 Use the ◀ / ▶ Buttons to select the Menu which contains the item you want to adjust or set and then press the ENTER Button.
- 3 Use the ◀ / ▶ Buttons to highlight the desired adjustment / setting icon and then press the ENTER Button.
- 4 Use the ◀ / ▶ Buttons again to make the appropriate adjustment or setting and then press the ENTER Button.
- 5 Press the EXIT Button to leave the menu, and the adjustment or setting you just made would be automatically saved.

For example, to correct for OSD vertical position, select Menu item of Setup Menu and then press the ENTER Button. Then, select OSD Vertical Position by using the ◀ / ▶ Buttons. An adjustment scale becomes active after you press the ENTER Button.

Use the ◀ / ▶ Buttons to change the OSD vertical position settings. The OSD vertical position of the overall display should be changing accordingly while you are doing this.

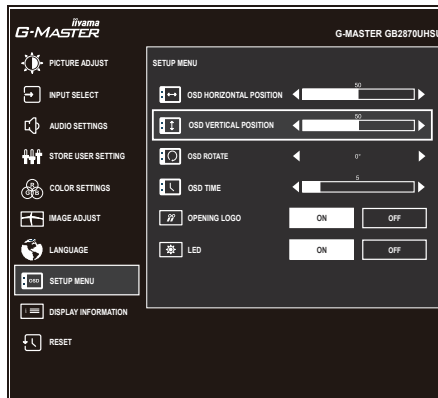

Press the ENTER Button and finally the EXIT Button to close the On Screen Display feature. All changes are saved in the memory.

NOTE

- When button operations are aborted during adjustment, On-Screen Display disappears when the time set for the OSD Time has passed. Also, press the EXIT Button to quickly turn off the On-Screen Display.
- Any changes are automatically saved in the memory when the On Screen Display disappears. Turning off the power should be avoided while using the Menu.
- All adjustments have only one setting which applies to all signal timings.

ADJUSTMENT MENU CONTENTS



Picture Adjust *1

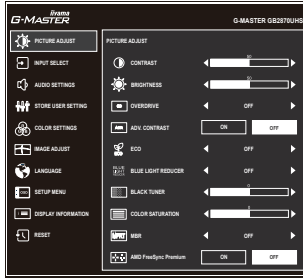

| Adjustment Item | Problem / Option | Button to Press |
|---|--|--|
| Contrast | Too dark Too bright | |
| Brightness *2 | Too dull Too intense | |
| Overdrive | Off / 1 / 2 / 3 / 4 / 5 It will improve the gray level response time of the LCD panel. A higher level results in a faster response time. | |
| Adv. Contrast *3 | On | Increased Contrast Ratio |
| | Off | Typical Contrast Ratio |
| Eco Direct | Off | Normal |
| | Mode1 | Brightness of back-light is reduced. |
| | Mode2 | Brightness of back-light is reduced more than Mode1. |
| | Mode3 | Brightness of back-light is reduced more than Mode2. |
| Blue Light Reducer | Off | Typical |
| | Mode1 | Blue light is reduced. |
| | Mode2 | Blue light is reduced more than Mode1. |
| | Mode3 | Blue light is reduced more than Mode2. |
| Black Tuner | From -5 to +5 You can adjust Dark shades. | |
| Color Saturation | Too weak | |
| | Too strong | |
| MBR *3,4 | Off / 1 / 2 / 3 / 4 / 5 / 6 / 7 Improve the moving picture response time of the LCD panel. | |
| AMD FreeSync Premium | On | Enable the FreeSync function. |
| | Off | The FreeSync function is turned off. |

- *1 The availability of each item depends on which item is activated. See the Function Correlation Matrix below for more details.
- *2 Adjust the Brightness when you are using the monitor in a dark room and feel the screen is too bright.
- *3 Not available when AMD FreeSync Premium is active.
- *4 MBR is available only when the refresh rate is higher than 75Hz.

Direct

You can skip the Menu items and directly display an option setting screen by using the following button operations.

- ECO : Press the  Button when the Menu is not displayed.

■ Function Correlation Matrix

| Selected item \ Active item | Picture Adjust | | | | Image Adjust | Your Computer |
|-----------------------------|----------------|-----|--------------------|-----|---|---------------|
| | Adv.Contrast | Eco | Blue Light Reducer | MBR | i-Style Color | HDR |
| | | | | | Standard Sport Game FPS Game Strategy Game Text | |
| Contrast | – | ✓ | ✓ | ✓ | – | – |
| Brightness | – | – | ✓ | – | – | – |
| Overdrive | ✓ | ✓ | ✓ | – | – | ✓ |
| Adv. Contrast | – | – | – | – | – | – |
| Eco | – | – | – | – | – | – |
| Blue Light Reducer | – | – | – | – | – | – |
| Black Tuner | ✓ | ✓ | ✓ | – | – | – |
| MBR | – | – | – | – | – | – |
| AMD FreeSync Premium | ✓ | ✓ | ✓ | – | ✓ | ✓ |

✓ : Available
 – : Not available

Input Select



| Adjustment Item | | Option | | |
|---|---------------|--------|--|---|
| Input Source | Direct | Auto | Search for an available input source and select automatically. | |
| | | Manual | HDMI | Select the Digital (HDMI) input. |
| | | | DP | Select the Digital (DisplayPort) input. |
| NOTE Input source is fixed, not selected automatically when HDMI and DisplayPort are selected. | | | | |

Direct



You can skip the Menu items and directly display an option setting screen by using the following button operations.

- Input Source : Press the INPUT Button when the Menu is not displayed.

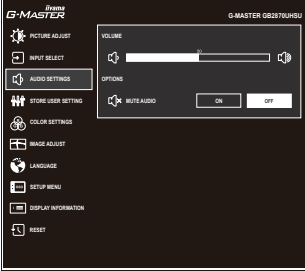

Audio Settings



| Adjustment Item | Problem / Option | Button to Press |
|---|----------------------|--|
| Volume Direct | Too soft Too loud |   |
| Mute Audio | On | Turn off the sound temporarily. |
| | Off | Return the sound volume to the previous level. |

NOTE Mute On and Off are switched as follows by pressing the ◀ / ▶ Buttons successively.

⇒ On → Off

Direct

You can skip the Menu items and directly display an adjustment scale by using the following button operations.

- Volume : Press the  Button when the Menu is not displayed.



Store User Setting

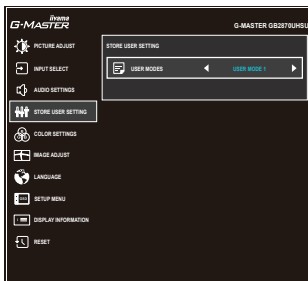

| Adjustment Item | Option | |
|-----------------|-------------|---|
| User Modes | User Mode 1 | Save the settings of the screen adjustment. |
| | User Mode 2 | Save the settings of the screen adjustment. |
| | User Mode 3 | Save the settings of the screen adjustment. |

NOTE

You can memorize your customized monitor settings.

The following settings can be memorized:

Contrast, Brightness, Overdrive, Adv. Contrast, Eco, Black Tuner, Color Saturation, Gamma, Volume, Mute Audio, Color Temperature, User Preset, Sharp and Soft, Video Mode Adjust, X-Res Technology



Color Settings



| Adjustment Item | Problem / Option | | Button to Press | |
|----------------------------------|------------------|------------------------|------------------------|------|
| Color Temperature * ¹ | Cool | Cool color | | |
| | Normal | Normal color | | |
| | Warm | Warm color | | |
| 6-Axis * ¹ | Hue | Red | Too weak Too strong | |
| | | Yellow | | |
| | | Green | | |
| | | Cyan | | |
| | | Blue | | |
| | Saturation | Red | Too weak Too strong | |
| | | Yellow | | |
| | | Green | | |
| | | Cyan | | |
| | | Blue | | |
| User Preset * ¹ | Red | Too weak Too strong | | |
| | Green | | | |
| | Blue | | | |
| Gamma * ² | Gamma1 | | | |
| | Gamma2 | | | |
| | Gamma3 | | | |

*¹ Not available when Blue Light Reducer or HDR settings on your computer are active.

*² Not available when HDR settings on your computer is active.

Image Adjust

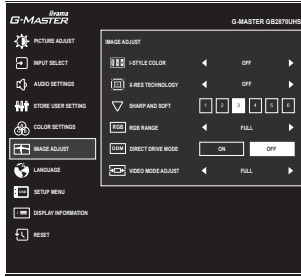

| Adjustment Item | Option | | Button to Press |
|------------------------------|---------------|--|-----------------|
| i-Style Color * ¹ | Off | Return to a state set by color adjustment except i-Style Color. | |
| | Standard | For general windows environment and monitor default setting | |
| | Sport Game | For Sports game environment | |
| | FPS Game | For FPS game environment | |
| | Strategy Game | For Strategy game environment | |
| | Text | For text editing and viewing in a word processing environment | |
| | User Mode 1 | Applies customized monitor settings. | |
| | User Mode 2 | Applies customized monitor settings. | |
| | User Mode 3 | Applies customized monitor settings. | |
| X-Res Technology | Off | Normal | |
| | Soft | Enhance the picture edge. | |
| | Middle | Enhance the picture edge more than the Soft option. | |
| | Hard | Enhance the picture edge more than the Middle option. | |
| Sharp and Soft | 1 2 3 4 5 6 | <p>You can change the picture quality from 1 to 6 (sharp to soft). Press the ► Button to change the picture quality in numerical order. Press the ◀ Button to change the picture quality in reverse numerical order.</p> | |
| RGB Range | Full | For full-range color scale signal | |
| | Limited | For limited color scale signal | |
| | Auto | Automatically select color scale signal. | |

*¹ Not available when Blue Light Reducer or HDR settings on your computer are active.

Direct

You can skip the Menu items and directly display an option setting screen by using the following button operations.

- i-Style Color: Press the i Button when the Menu is not displayed.

Image Adjust

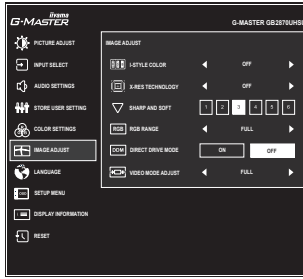

| Adjustment Item | Option | |
|------------------------|----------|---|
| Direct Drive Mode *2,3 | On | Reduce the input-lag. |
| | Off | Typical |
| Video Mode Adjust | Full | Expansion display |
| | 17inch | Display the picture as 17 inch screen (5 : 4). |
| | 19.5inch | Display the picture as 19.5 inch screen (16 : 9). |
| | 21.5inch | Display the picture as 21.5 inch screen (16 : 9). |
| | 23inch | Display the picture as 23 inch screen (16 : 9). |
| | 23.6inch | Display the picture as 23.6 inch screen (16 : 9). |
| | 24inch | Display the picture as 24 inch screen (16 : 9). |

*2 Direct Drive Mode can not be selected when AMD FreeSync Premium is activated.

*3 Direct Drive Mode can not be selected if "Video Mode Adjust" function is selected other than Full.



Language

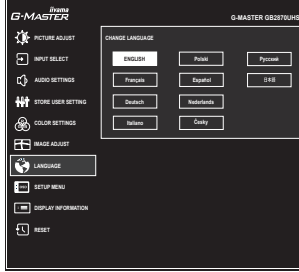







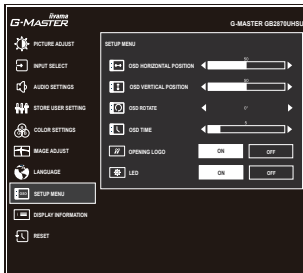

ENGLISH

| Adjustment Item | Option | | | |
|-----------------|----------|---------|------------|----------|
| Language | English | English | Español | Spanish |
| | Français | French | Nederlands | Dutch |
| | Deutsch | German | Česky | Czech |
| | Italiano | Italian | Русский | Russian |
| | Polski | Polish | 日本語 | Japanese |

OSD Setup Menu



| Adjustment Item | Problem / Option | Button to Press |
|-------------------------|---|---|
| OSD Horizontal Position | OSD is too left OSD is too right |   |
| OSD Vertical Position | OSD is too low OSD is too high |   |
| OSD Rotate | Rotate the OSD. 0° (Normal) / +90° (Rotate right) / -90° (Rotate left) |   |
| OSD Time | You can set the OSD display duration time between 5 and 30 seconds. |   |
| Opening Logo | On | G-MASTER Logo is displayed when the monitor is turned on. |
| | Off | G-MASTER Logo is not displayed when the monitor is turned on. |
| LED | On | The Power Indicator is turned On. |
| | Off | The Power Indicator is turned Off. |

NOTE Turn Off the Power Indicator when you are bothered by the light.



Display Information



Displays information regarding the current input signal coming from the graphic card in your computer.

"HDR: ON" or "HDR: OFF" will be displayed depending on the settings of your computer.

NOTE See your graphic card user guide for more information about changing the resolution and refresh.



Reset

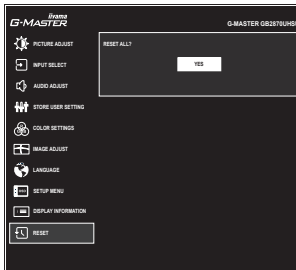

Adjustment Item

Option

Yes

Factory-preset data is restored.

● Lock Mode

<OSD Menu>

Pressing and holding the ENTER button for 10 seconds when Menu is not displayed, it will lock/unlock the OSD Lock function.

<Power Switch>

Pressing and holding the ◀ button for 10 seconds when Menu is not displayed, will lock/unlock the Power Lock function.

STANDBY FEATURE

This product features the standby function. When activated, it automatically reduces unnecessary power consumption of the monitor when your computer is not in use.

There is a standby step the monitor takes as described below. The standby function, including any timer settings is configured by the operating system. Check your operating system manual for information on how this can be configured.

■ Standby Mode

When the video signal from the computer is off, the monitor enters into Standby Mode which reduces the power consumption to less than 0.5W*. The screen becomes dark, and the power indicator turns to orange. From Standby Mode, the image reappears in several seconds when either the keyboard or the mouse are touched again.

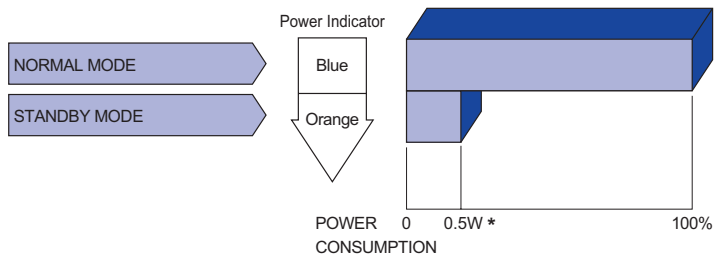

* When the USB devices are not connected.

TROUBLE SHOOTING

If the monitor fails to operate correctly, please follow the steps below for a possible solution.

1. Perform the adjustments described in OPERATING THE MONITOR, depending on the problem you have. If the monitor does not get a picture, skip to 2.
2. Consult the following items if you cannot find an appropriate adjustment item in OPERATING THE MONITOR or if the problem persists.
3. If you are experiencing a problem which is not described below or you cannot correct the problem, discontinue using the monitor and contact your dealer or iiyama service center for further assistance.

| Problem | Check |
|--|---|
| ① The picture does not appear. (Power indicator does not light up.) (Power indicator is blue.) (Power indicator is orange.) | <input type="checkbox"/> The Power Cable is firmly seated in the socket. <input type="checkbox"/> The Power Switch is turned ON. <input type="checkbox"/> The AC socket is live. Please check with another piece of equipment. <input type="checkbox"/> If the blank screen saver is in active mode, touch the keyboard or the mouse. <input type="checkbox"/> Increase the Contrast and/or Brightness. <input type="checkbox"/> The computer is ON. <input type="checkbox"/> The Signal Cable is properly connected. <input type="checkbox"/> The signal timing of the computer is within the specification of the monitor. <input type="checkbox"/> If the monitor is in standby mode, touch the keyboard or the mouse. <input type="checkbox"/> The computer is ON. <input type="checkbox"/> The Signal Cable is properly connected. <input type="checkbox"/> The signal timing of the computer is within the specification of the monitor. |
| ② The screen is not synchronized. | <input type="checkbox"/> The Signal Cable is properly connected. <input type="checkbox"/> The signal timing of the computer is within the specification of the monitor. |
| ③ The screen position is not in the center. | <input type="checkbox"/> The signal timing of the computer is within the specification of the monitor. |
| ④ The screen is too bright or too dark. | <input type="checkbox"/> The video output level of the computer is within the specification of the monitor. |

Problem

Check

- | | |
|---------------------------------------|---|
| ⑤ The screen is shaking. | <input type="checkbox"/> The power voltage is within the specification of the monitor. <input type="checkbox"/> The signal timing of the computer is within the specification of the monitor. |
| ⑥ No sound. | <input type="checkbox"/> The audio equipment (computer etc.) is ON. <input type="checkbox"/> The Volume is turned up. <input type="checkbox"/> The Mute is OFF. <input type="checkbox"/> The audio output level of the audio equipment is within the specification of the monitor. |
| ⑦ The sound is too loud or too quiet. | <input type="checkbox"/> The audio output level of the audio equipment is within the specification of the monitor. |

RECYCLING INFORMATION

For better environment protection please don't dispose your monitor.
Please visit our web site: www.iiyama.com for monitor recycling.

APPENDIX

Design and specifications are subject to change without prior notice.

SPECIFICATIONS

| | | |
|--|--|---|
| Size Category | 28" | |
| LCD Panel | Panel technology | IPS (In-Plane-Switching) |
| | Size | Diagonal: 28" (71cm) |
| | Pixel pitch | 0.16mm H × 0.16mm V |
| | Brightness | 300cd/m ² (Typical), 400cd/m ² (HDR peak) |
| | Contrast ratio | 1000 : 1 (Typical), Adv. Contrast function available |
| | Viewable angle | Right / Left: 89 degrees each, Up / Down: 89 degrees each (Typical) |
| | MPRT | 1ms |
| Display Colors | Approx. 16.7M | |
| Sync Frequency | Horizontal: 30.0-320.0kHz, Vertical: 48-150Hz | |
| Native Resolution | 3840 × 2160, 8.2 MegaPixels | |
| Support max. resolution | HDMI: 3840 × 2160 150Hz DisplayPort: 3840 × 2160 150Hz | |
| Input Connector | HDMI, DisplayPort | |
| Input Video Signal | HDMI, DisplayPort | |
| USB Standard | USB3.0 (DC5V, 900mA) | |
| Number of USB Ports Connector shape | 1 Upstream: Series B 3 Downstream: Series A | |
| Headphone Connector | ø 3.5mm mini jack (Stereo) | |
| Speakers | 2W × 2 (Stereo speakers) | |
| Maximum Screen Size | 620.93mm W × 341.28mm H / 24.4" W × 13.4" H | |
| Power Source | 100-240VAC, 50/60Hz, 2.0A | |
| Power Consumption* | 36W typical, Standby mode: 0.5W maximum, Off mode: 0.3W maximum | |
| Dimensions / Net Weight | 636.5 × 413.0 - 543.0 × 256.0mm / 25.1 × 16.3 - 21.4 × 10.1" (W×H×D) 6.9kg / 15.2lbs | |
| Angle | Tilt: Upward: 18 degrees Downward: 3 degrees Rotation: Clockwise / Counterclockwise: 90° each | |
| Environmental Considerations | Operating: Temperature 5 to 35°C / 41 to 95°F Humidity 10 to 85% (No condensation) Storage: Temperature -20 to 60°C / -4 to 140°F Humidity 5 to 85% (No condensation) | |
| Approvals | CE, UKCA, TÜV-Bauart, VCCI, EAC, PSE | |

NOTE

* When the USB devices are not connected.

DIMENSIONS

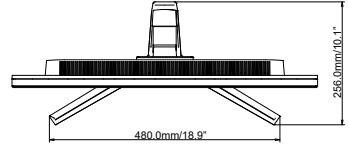
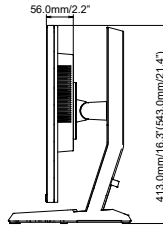
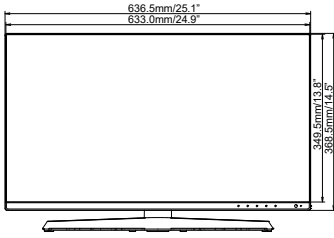

() : Maximum adjustment range

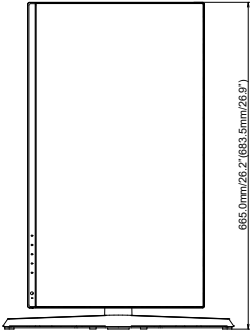

COMPLIANT TIMING

| Video Mode | Horizontal Frequency | Vertical Frequency | Dot Clock |
|-------------|----------------------|--------------------|-------------|
| 640 × 480 | 31.469kHz | 59.940Hz | 25.175MHz |
| | 37.500kHz | 75.000Hz | 31.500MHz |
| | 37.861kHz | 72.809Hz | 31.500MHz |
| 800 × 600 | 35.156kHz | 56.250Hz | 36.000MHz |
| | 37.879kHz | 60.317Hz | 40.000MHz |
| | 48.077kHz | 72.188Hz | 50.000MHz |
| | 46.875kHz | 75.000Hz | 49.500MHz |
| 1024 × 768 | 48.363kHz | 60.004Hz | 65.000MHz |
| | 60.023kHz | 75.029Hz | 78.750MHz |
| 1280 × 1024 | 63.981kHz | 60.020Hz | 108.000MHz |
| | 79.976kHz | 75.025Hz | 135.000MHz |
| 1440 × 900 | 55.935kHz | 59.887Hz | 106.500MHz |
| 1600 × 900 | 60.000kHz | 60.000Hz | 108.000MHz |
| 1600 × 1200 | 75.000kHz | 60.000Hz | 162.000MHz |
| 1680 × 1050 | 65.290kHz | 60.000Hz | 146.250MHz |
| 1920 × 1080 | 66.590kHz | 59.930Hz | 138.500MHz |
| 2560 × 1440 | 88.787kHz | 59.951Hz | 241.500MHz |
| | 222.060kHz | 143.912Hz | 592.000MHz |
| 3840 × 2160 | 133.313kHz | 59.997Hz | 533.250MHz |
| | 274.165kHz | 119.880Hz | 1074.730MHz |
| | 318.877kHz | 143.963Hz | 1250.000MHz |
| | 334.700kHz | 150.000Hz | 1312.000MHz |

| Console | 1080P (1920 × 1080) | 1440P (2560 × 1440) | 2160P (3840 × 2160) |
|-----------------|------------------------|------------------------|------------------------|
| PS5 | 60/120Hz | - | 60/120Hz |
| Xbox series X/S | 60/120Hz | - | 60/120Hz |